

# INSTRUCTION

## SHX

### SHXI/SHPI

# STAIL LED

6030

6031



# REGIOLUX

Regiolux GmbH  
 Hellinger Str. 3  
 D-97486 Königsberg/Bay.  
 T 09525 89-0  
<http://www.regiolux.de>  
[info@regiolux.de](mailto:info@regiolux.de)

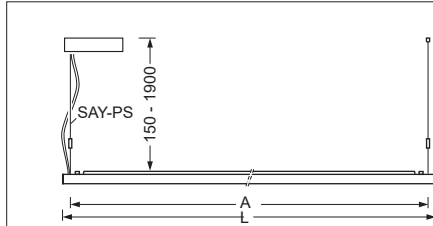

	L	A
SH./SH.I /1200	1240	1216
SH./SH.I /1500	1540	1516

Diese Leuchte enthält ein Leuchtmittel der Energieeffizienzklasse **B**  
 This luminaire contains a light source of energy efficiency class **B**

**Achtung:**  
 Leuchte nicht öffnen!  
 Garantieverlust!

**Attention:**  
 Ne pas ouvrir le luminaire!  
 Perte de garantie!

**Attention:**  
 Don't open the luminaire!  
 Loss of Guarantee!

**Atención:**  
 No abrir la luminaria!  
 Pérdida de garantía!

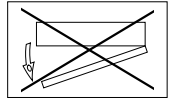

SAY-PS 1900/190

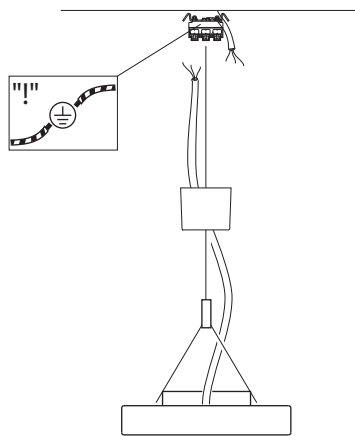
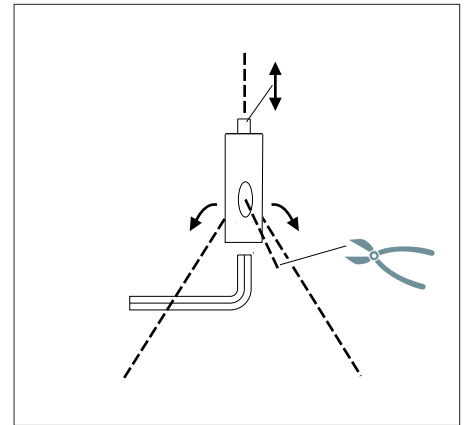
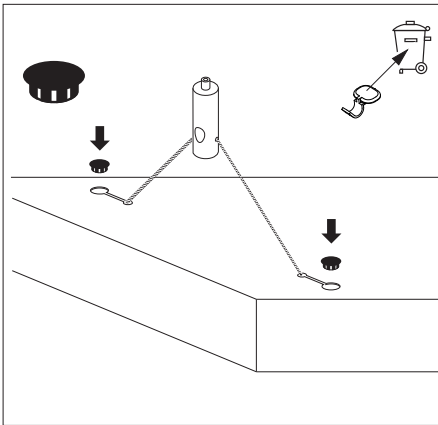
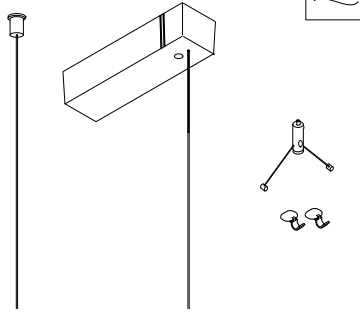

## DALI

- Ein / Aus / Dimmen -
- On / Off / Dimming -

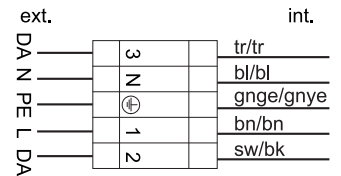
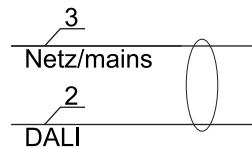

- Ein / Aus / Tast-Dim -
- On / Off / Touch dim -

