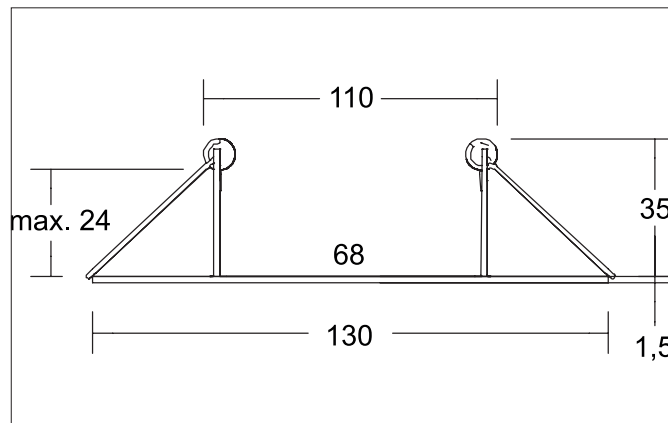

Reducing ring D 130 mm, for luminaire cut-out size 68 mm

Article no. 81202370

Tender

Reducing ring D 130 mm, for luminaire cut-out size 68 mm, white matt. Reducing ring with inner hole 68 mm. Diameter: 130 mm. The final installation depth depends on the installed luminaire. Installation depth without light: 34 mm. Maximum ceiling thickness: 16 mm, height: 1.5 mm. Can be used for on-site opening of 110 mm. Material: Steel.

Product Benefits

- Passend zu den Serien BB03, BB18, BB33, BB34, BB35, TIRREL-R, TIRRELdeep, SEVEN-R, LAKIL-R, PAYTON-R, INDIWO68-R, JARRID-R, DISC und BRONNY.

Article data	
Article no.	81202370
GTIN	4251433999072
Short description	Reducing ring D 130 mm, for luminaire cut-out size 68 mm
Material	Steel
Colour	White
Type of surface	Matt
Weight	0.078 kg
Conformance	CE, UKCA

Reducing ring D 130 mm, for luminaire cut-out size 68 mm
Article no. 81202370

Packing data	
Gross weight	0.109 kg
Length of packaging	135 mm
Packaging width	45 mm
Packaging height	135 mm
Disposal at end of life	<p>This product must not be disposed of with household waste. You are obliged, to dispose of such electrical waste separately.</p> <p>By disposing of electrical waste and other old or defective electronics separately, you support recycling or other forms of re-use. In that way you help to take care and to avoid that harmful substances get into the environment.</p>