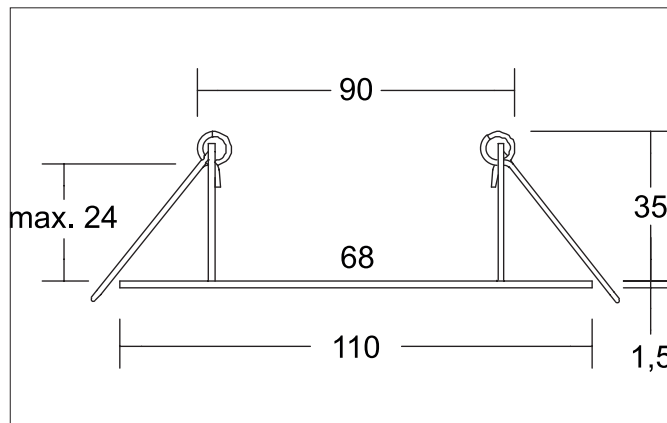

Reducing ring D 110 mm, for luminaire cut-out size 68 mm

Article no. 81201150

Tender

Reducing ring D 110 mm, for luminaire cut-out size 68 mm, nickel satin. Reducing ring with inner hole 68 mm. Diameter: 110 mm. The final installation depth depends on the depends on the installed luminaire. Installation depth without light: 34 mm. Maximum ceiling thickness: 16 mm, height: 1.5 mm. Can be used for on-site opening of 90 mm. Material: Steel.

Product Benefits

- Passend zu den Serien BB03, BB18, BB33, BB34, BB35, TIRREL-R, TIRRELdeep, SEVEN-R, LAKIL-R, PAYTON-R, INDIWO68-R, JARRID-R, DISC und BRONNY.

Article data	
Article no.	81201150
GTIN	4251433999164
Short description	Reducing ring D 110 mm, for luminaire cut-out size 68 mm
Material	Steel
Colour	Nickel
Type of surface	Matt
Weight	0.046 kg
Conformance	CE, UKCA

Reducing ring D 110 mm, for luminaire cut-out size 68 mm
Article no. 81201150

Packing data	
Gross weight	0.07 kg
Length of packaging	115 mm
Packaging width	45 mm
Packaging height	115 mm
Disposal at end of life	<p>This product must not be disposed of with household waste. You are obliged, to dispose of such electrical waste separately.</p> <p>By disposing of electrical waste and other old or defective electronics separately, you support recycling or other forms of re-use. In that way you help to take care and to avoid that harmful substances get into the environment.</p>