



AK - Simply more values.
Product manual

Table of contents

About this product manual	5
AK-Small Distribution Board	5
Intended use.....	5
Project planning aids according to standard	5
Safety information	6
Meaning of the symbols	6
Areas of application	7
Operational limits	7
Ambient temperature	7
Air humidity	7
Maximum installation elevation	7
Product characteristics	8
Insulating material enclosure.....	8
Degree of contamination	8
Electrical characteristics	8
Protection rating.....	8
IP protection rating	8
IK protection rating	8
Scope of supply	9
Equipment	10
Condensate formation.....	11
Air® ventilation element.....	11
Box	12
Box floor.....	12
Side walls.....	14
Top/bottom ends	15
Interior.....	15
Top part.....	18
Device cut-out	18
Hinged window	19
Accessories	20
Flange / combination flange	20
Combination screw coupling	20
Assembly plate	20
Partition wall	21
Cable cover with document compartment	21
Standard rail with universal floor fastening	21
Mounting	22
Operating position	22
Mounting the box	23
Work preparation	24
Cable insertions	24
Pre-embossing	24
Air® ventilation element	25
Drainage openings	26

3-point keyhole mounting	27
Mounting with external fixing lugs	28
Mounting outside the sealing area	29
Basic work	30
Standard rail	30
Standard rail holder	31
Assembly plate	32
Standard rails with universal floor fastening NS35-275	33
Flange / flange connector	34
Combination flange / flange connector	35
Combination screw coupling AK3 KS M50	36
Partition wall AK3 TW	36
Schuko socket AK STD	37
Mounting the top part	38
Expansion of the device cut-out	38
Changing the window closure	38
Close window / seal	38
Close top part.....	39
Cable cover with document compartment.....	40
Maintenance.....	40
Project planning	41
When which standard should be applied.....	41
Project planning per EN -2442	42
Title of the standard.....	42
Application areas according to the standard.....	42
Classification of the AK-Small distribution board	42
Classification criteria according to chapter 7 of EN 60670-24	42
Protection against electric shock	43
Equipment for earthing	43
Construction.....	43
Insulation resistance and dielectric strength	43
Creepage distances, clearances.....	44
Verification of the maximum power output characteristics (Pde).....	44
Verification of heating	44
Design rules for use as a GP enclosure	45
Design rules for use as a PD enclosure	48
Project planning per EN 6143952.....	52
Title of the standard.....	52
Original manufacturer / switchgear combination manufacturer	52
Application areas according to the standard.....	52
Type verification according to section 10 of EN 61439-1/-3.....	53
Unit verification according to section 11 of EN 61439-1/-3.....	61

Project planning per EN 61439-2	62
Title of the standard	62
Annex.....	63
Technical data	63
AK-Small Distribution Board	64
AK-F Small Distribution Board	65
AK-Plus-Small Distribution Board	66
AK-F-Plus Small Distribution Board	67
AK / AK-F-Small Distribution Board	68
Dimensional drawings	70

About this product manual

This product manual is a project planning and installation manual and has been written for specialist skilled workers. Read this product manual carefully, in order to select, safely install and operate the AK-Small distribution board, and fully utilise the permissible application options that it offers.

AK-Small Distribution Board

The AK-Small distribution board belongs to a product range of small distribution boards of varying sizes and design variants. The different equipment variants are reflected in the respective name extension. When utilised in accordance with this product manual, it fulfils the requirements of the standards:

- EN 60670-24
- EN 61439-2
- EN 61439-3

Irrespective of the information provided in this product manual, the installer is responsible for applying the respective valid standard and the processes described within it.

Intended use

The AK-Small distribution board is suitable for the installation of:

- Rail mounted devices, in particular protective and control devices
- Low-voltage and switchgear combinations

It is essential to comply with the limitations of use described in this product manual and the limit values applicable due to the product characteristics.

The specifications provided in this product manual with respect to mounting the AK-Small distribution board, the wiring and the equipment installation must be observed.

Project planning aids according to standard

In the following, Spelsberg supports the professional installation of the AK-Small distribution board according to the standards:

- EN 60670-24
- EN 61439-2
- EN 61439-3

Within the framework of the standards EN 60670-24 and EN61439-3, the AK-Small distribution board is suitable for operation by laypersons.

Safety information

- The AK-Small distribution board must be installed and put into operation exclusively by qualified electricians.
- Depending on the use of the AK-Small distribution board, operation of the integrated devices by laypersons or authorised persons is permitted.
- In the event of damage to the enclosure, whereby the original protection rating is no longer provided, a qualified electrician must assess whether it is necessary to decommission the AK-Small distribution board.
- If the small distribution board is accessible to laypersons and protection of the enclosure against contact with hazardous parts and the penetration of fixed bodies is less than IP3x (protection against contact with tools, wires, foreign bodies, etc. > Ø 2.5 mm) then the distributor must be put out of operation!
- The AK-Small distribution board without hinged window has a protection rating of IP30. Any modules that are not in use must be closed with masking off strips.
- The sealing plugs M16 and M20 serve exclusively to close the fastening holes in the enclosure floor. Due to their reduced leak-tightness of IP54, these are not suitable for the cable insertion.
- Irrespective of the information in this product manual, the valid standards and regulations apply in their most recent valid form.

Meaning of the symbols



Danger

A failure to observe leads to death or serious injury.

Withdraw from the danger.



Warning

A failure to observe can lead to death or serious injuries.

Withdraw from the danger.



Caution

A failure to observe can lead to injuries.

Withdraw from the danger.



Note

Explanatory note

Important supplementary information regarding the AK-Small distribution board.

Areas of application

The AK-Small distribution board is suitable for surface mounting. It is suitable for indoor and outdoor installation.

Operational limits

The AK-Small distribution board is suitable for use with the following operational limits, with consideration to the respective valid standard without consultation with Spelsberg.

Ambient temperature

Minimum ambient temperature: – 25°C

Maximum ambient temperature: + 40°C

The average temperature over 24 hours must not exceed 35°C.



Note

Special operating conditions

When used in outdoor areas, temperatures around freezing may freeze the seals on the top part or on the hinged window. If opened without due care, this may result in damage to the seal.



Note

Special operating conditions

If the AK-Small distribution board is to be used outside of the aforementioned temperature limits it is necessary to consult with Spelsberg technical sales personnel.

Tel: +49 (0) 23 55 / 892-155

Air humidity

The permissible air humidity is determined based on the maximum ambient temperature.

It is 50 % with a maximum ambient temperature of 40°C.

It is 100 % with a maximum ambient temperature of 25°C.

Maximum installation elevation

The maximum installation elevation is limited to 2000 m above sea level, due to the reduction in the dielectric strength and the cooling effect of the ambient temperature at significant elevations.



Note

Special operating conditions

If the AK-Small distribution board is to be used at elevations higher than 2000 m above sea level it is necessary to consult with Spelsberg technical sales personnel.

Tel: (+49) 0 23 55 / 892-155

Product characteristics

Insulating material enclosure

The AK-Small distribution board is produced from thermoplastics (type-tested brand products). It is an insulating material enclosure and therefore has no earthing device.

Degree of contamination

The AK-Small distribution board is designed for use in application areas with a degree of contamination of 3.

Electrical characteristics

The AK-Small distribution board is approved for use in electrical networks with a rated current of up to 400 V, in which the prospective short circuit current (I_{cp}) does not exceed 10 kA.

If a feed with a higher I_{cp} is to be anticipated then a current-limiting protective device with a maximum switch-off current of 17 kA must be included (e.g. AKi-T 201, order no. 786 201 01 from Spelsberg).

The AK-Small distribution board is suitable for a rated insulation voltage of up to 1000V AC / 1500V DC.

The maximum feed current must not exceed 125 A.

Protection rating

IP protection rating

The AK-Small distribution board has an IP protection rating of IP65 with closed hinged windows.

This value applies to an open and closed Air@ ventilation element.

With open hinged windows, the IP protection rating reduces from IP65 to IP30.

Depending on the cable insertion used, the IP protection rating reduces further.



Note

Use of sealing plugs

The sealing plugs provided by Spelsberg have an IP protection rating of IP54.

If the sealing plugs are used as intended to cover the

screw heads, the resultant IP protection rating for the overall enclosure does not reduce.

IK protection rating

The IK protection rating is the measure for the resistance of enclosures to harmful mechanical stresses, in particular impact stresses.

	AK AK Plus	AK-F AK-F Plus
Top part	IK08	IK08
Side walls	IK08	IK08
Top/bottom ends	IK07	IK08 with smooth flange

Stress energy:

IK07 \triangleq 2 Joules

IK08 \triangleq 5 Joules

The IK protection rating has been tested at -25°C.

The IK protection rating does not apply to break out openings.

Scope of supply

The AK-Small distribution board is delivered including:

- Box
- Top part with hinged windows
- Mounting instructions with labelling strips
- Accessory set, comprising double membrane seals (DMS), sealing plugs (VST), Attachment bushes (AST) and masking off strips (AK-AS).

Accessory set contents	AST M40	DMS M16	DMS M20	DMS M25	DMS M32	VST M16	VST M20	AK-AS 6TE
AK 14 / AK-F 14	1	1	5	2	1	4	1	2
AK 28 / AK-F 28 AK Plus 14 / AK-F Plus 14	1	1	5	2	1	4	1	2
AK 42 / AK-F 42 AK-F Plus 28 / AK-F Plus 28	2	2	10	4	2	8	2	4
AK 56 / AK-F 56 AK Plus 42/ AK-F Plus 42	2	2	10	4	2	8	2	4
AK 70	2	2	10	4	2	8	2	4

Table 1: Accessory set

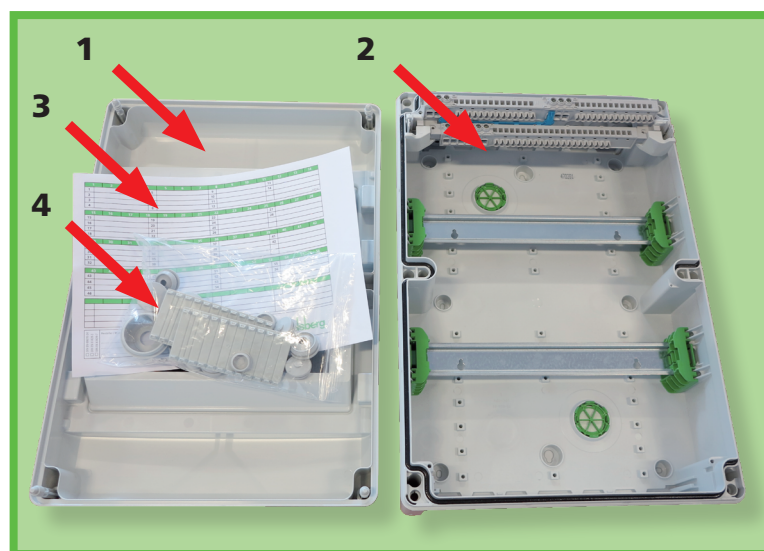

1	Top part
2	Box
3	Download mounting instructions with labelling strips: www.spelsberg.de
4	Accessory set

Figure 1: AK-Small distribution board scope of supply



Note

Disposal of the packaging material

Packaging materials must be submitted for recycling.

Equipment

The AK-Small distribution board consists of a box and cover.

The AK-Small distribution board is available in a range of equipment variants. All equipment variants are offered in various sizes, see chapter „Technische Daten“, Seite 63.

The following variants are characterised by the different design forms of the enclosure and equipment with installation materials:

- AK-Small distribution board
- AK-F-Small distribution board
- AK Plus-Small distribution board
- AK-F Plus-Small distribution board

The AK-Small distribution board is the basic model in the range. The cover of the basic model is equipped with hinged windows. Below the hinged windows are device cut-outs, which are suitable for installing rail mounted devices.

Standard rails are pre-installed beneath the device cut-outs. All enclosure sides are closed.

Unlike the basic model, the variants with the name extension "F" have open top/bottom ends, which must be closed with flanges.

The variants with the name extension "Plus" have an additional terminal compartment in the cover.

In order to avoid the formation of condensate, all AK-Small distribution boards are equipped with the Air® ventilation element.

Condensate formation

If non air-tight enclosures are used in environments with a fluctuating temperature and air humidity then condensate problems may arise.

The physical basis for this is that air at a certain temperature and a certain pressure can only absorb a certain maximum quantity of water vapour.

The higher the temperature and air pressure, the greater the maximum possible water content.

In comparison to a temperature of 55°C, air at a temperature of 20°C can only absorb 20 % of the water content.

Depending on the power losses given off by the installed devices, the air inside the enclosure commonly heats up to temperatures of up to 55°C. If suitable installed devices and cables are used then this temperature can be even higher. The warm air in the enclosure absorbs the water vapour contained in the ambient air over time.

If the outside temperature drops then the outer walls of the enclosure cool down. Upon reaching the dew point temperature, the water vapour contained within the air deposits on the inside of the enclosure as condensate.

The water collects inside the box and can cause damage here.

Air[®] ventilation element

In order to avoid the formation of condensate and reduce existing condensate, the AK-Small distribution board is fitted with the Air[®] ventilation element and drainage openings prescribed according to EN 60670-1.

The Air[®] ventilation element facilitates the avoidance of condensate whilst maintaining the high IP protection rating of IP65. Furthermore, it also supports the transportation of any condensate out of the enclosure within the shortest possible time through an air exchange. Through the steady air exchange, the air inside the enclosure can always mix with the ambient air and therefore transport the moisture outside.

Also in environments with almost constant air humidity and temperature, the air exchange takes place with the interior temperature rising due to the installations.

The elements essentially consist of the rotating cover fitted to the rear side of the box, and the filter element installed inside the box

„Illustration 4: Filterelement“

Box

The box comprises the box floor, two side walls, two top/bottom ends and the interior compartment.

Box floor

The box floor of all AK-Small distribution boards is equipped with:

- The Air® ventilation element
- Pre-embossing for wall mounting
- Pre-embossing for cable insertion
 - 2 combination insertions M40/32 and, depending on the enclosure size,
 - a varying number of combination insertions M25/20
- Mounting plug for fastening the installation material
- Screw bosses for fastening the cover
- Mounting points inside the sealing area
- Mounting points outside the sealing area
- Drainage openings

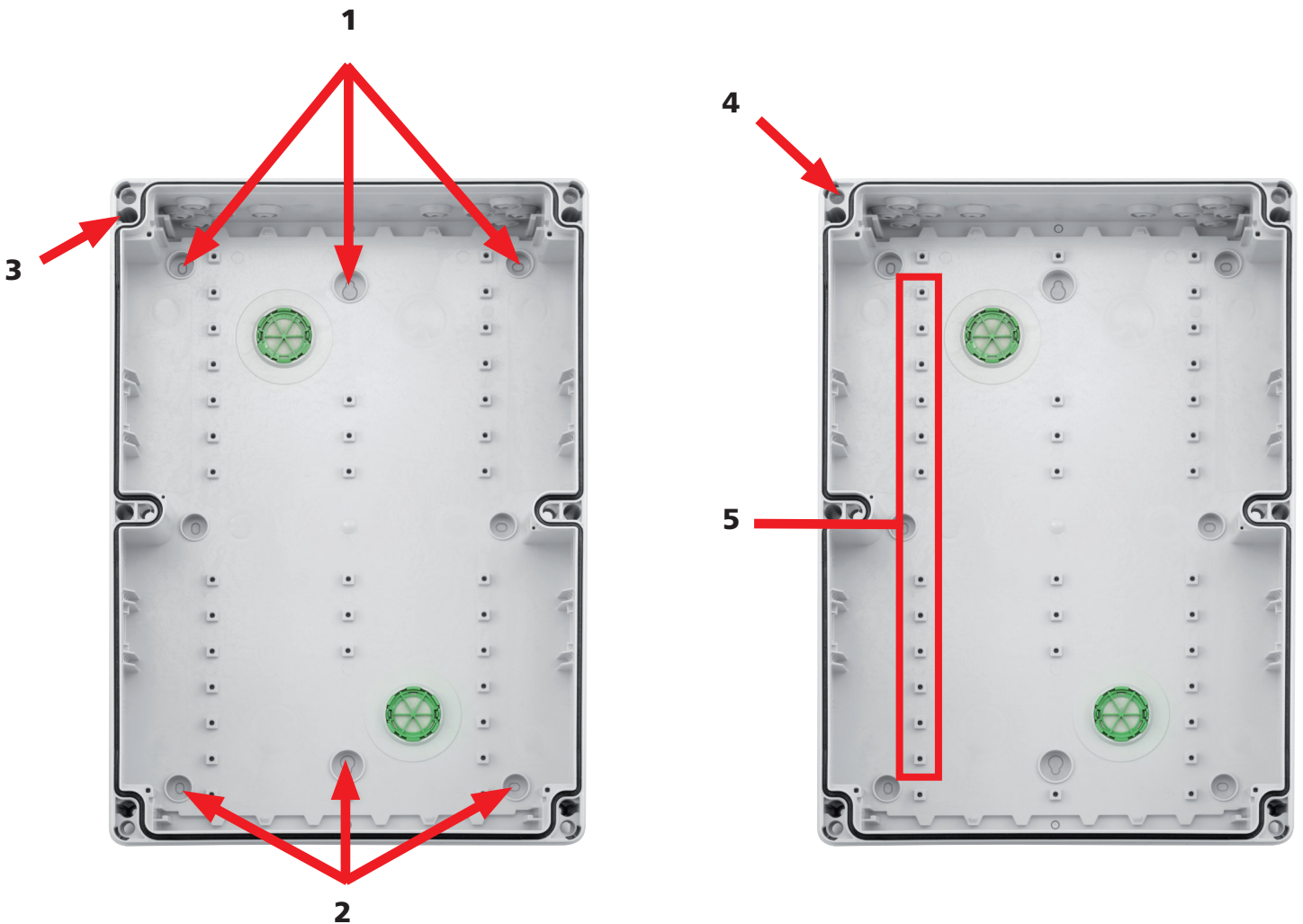

Figure 2: Box floor front side, rear side (image 1)

1 / 2	Mounting points inside the sealing area
3	Mounting points outside the sealing area
4	Screw bosses for cover fastening
5	Mounting plug for assembly plate

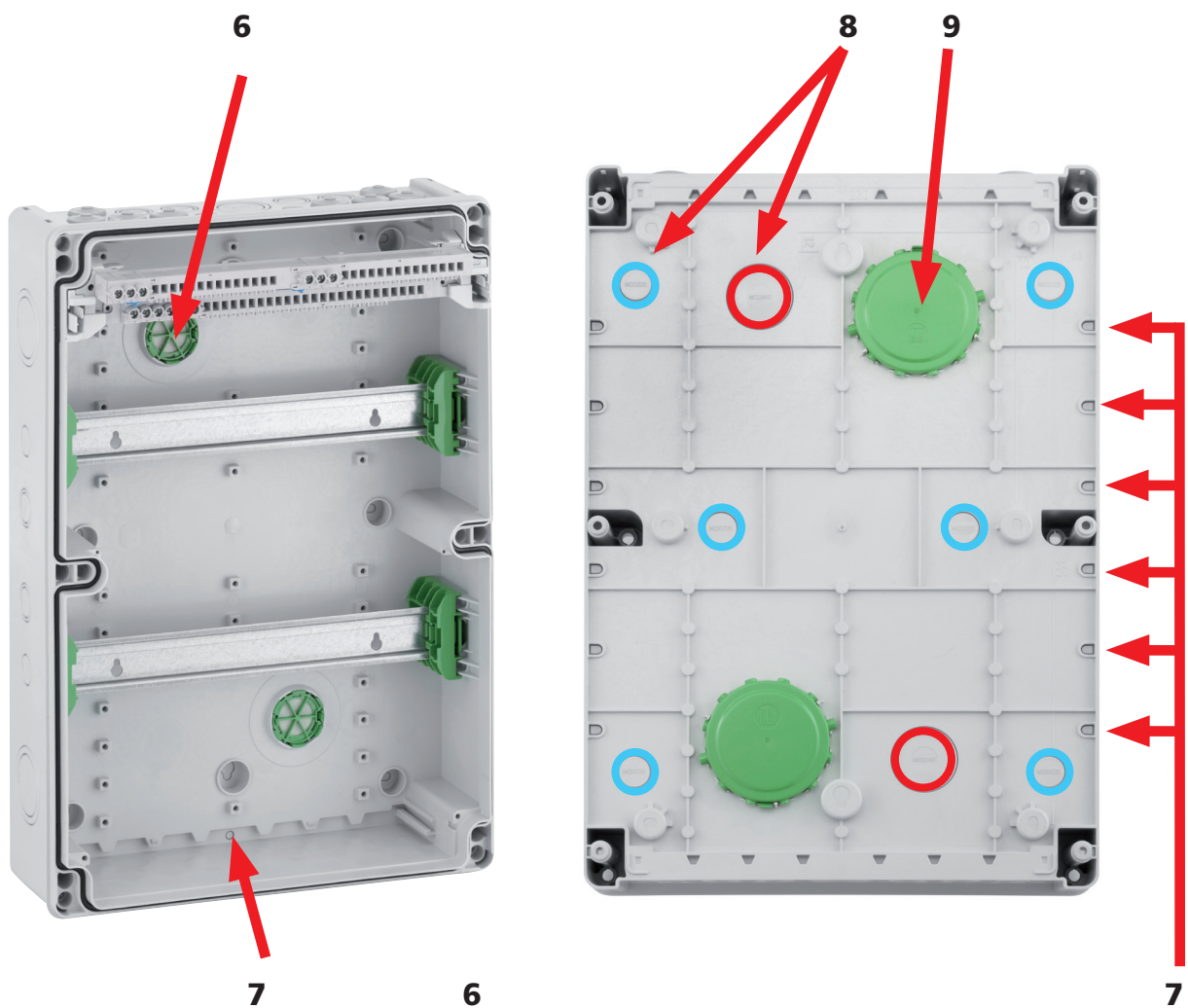

Figure 3: Box floor front side, rear side (image 2)

6	Air® ventilation element - filter element
7	Drainage openings
8	Pre-embossing for cable insertions
9	Air® ventilation element - cover

Filter Air® ventilation element

The Air® ventilation element is maintenance-free by design. The Air® ventilation element is equipped with an exchangeable filter element. The filter element retains particles which are 10 µm or larger. The filter is exchangeable.

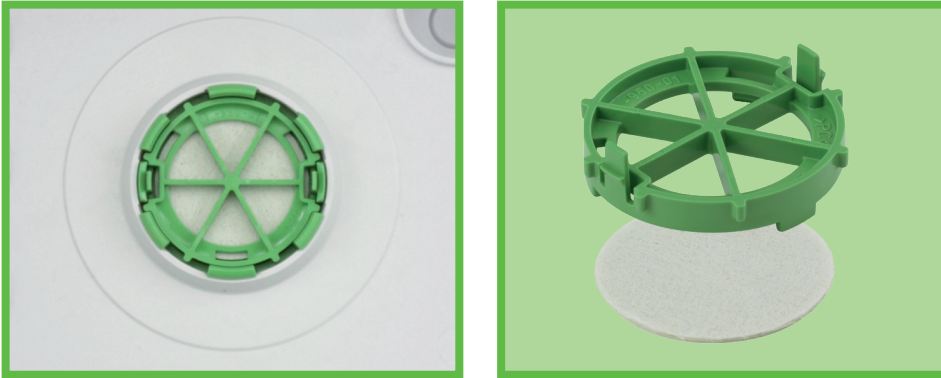

Figure 4: Filter element

Drainage openings



Figure 5: Drainage openings

With exceptional ambient conditions or a deactivated Air® ventilation element it is possible to open the drainage openings in the box.

Side walls

The two side walls are equipped with:

- 1) Pre-embossing for the cable insertion M20 and M20/25
- 2) Pre-embossing M50 for combination threaded connection AK3 KS M50
- 3) Drilling points for optional fastening of the Schuko socket AK3 STD

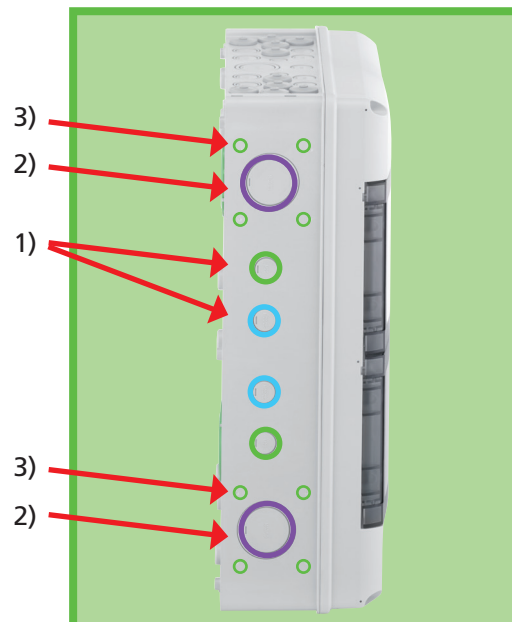

Each side part has two combination insertions M50/40, each with four drilled points. These facilitate side cable insertion via cable glands M40 or M50, for installation of the combination screw coupling (AK3 KS M50) or Schuko sockets (AK STD). The number of insertions M20 and combination insertions M25/20 varies depending on the size of the small distribution board, see chapter "Cable insertions enclosure sides", page 68

Top/bottom ends

The two top/bottom ends vary depending on the design form of the AK-Small distribution board



Figure 6: Top/bottom end in variants AK and AK-F

Design form: AK and AK-Plus

AK-Small distribution boards of types AK and AK-Plus are equipped with pre-embossing on both top/bottom ends for:

- 2 x insertion **M16**
- 4 x combination insertion **M25/20**
- 15 x insertion **M20**
- 1 x combination insertion **M40/32**

One top/bottom end is equipped with 10 DMS M20. The DMS are closed in as-delivered condition.

Design form: AK-F and AK-F Plus

AK-Small distribution boards of types AK-F and AK-F-Plus are open at both top/bottom ends and must be closed with flanges. The flanges are not included in the scope of supply and must be acquired separately.

Interior

The interior of the AK-Small distribution board serves to accommodate the equipment and is fitted with various mounting options depending on the variant.

Standard rail on standard rail holder

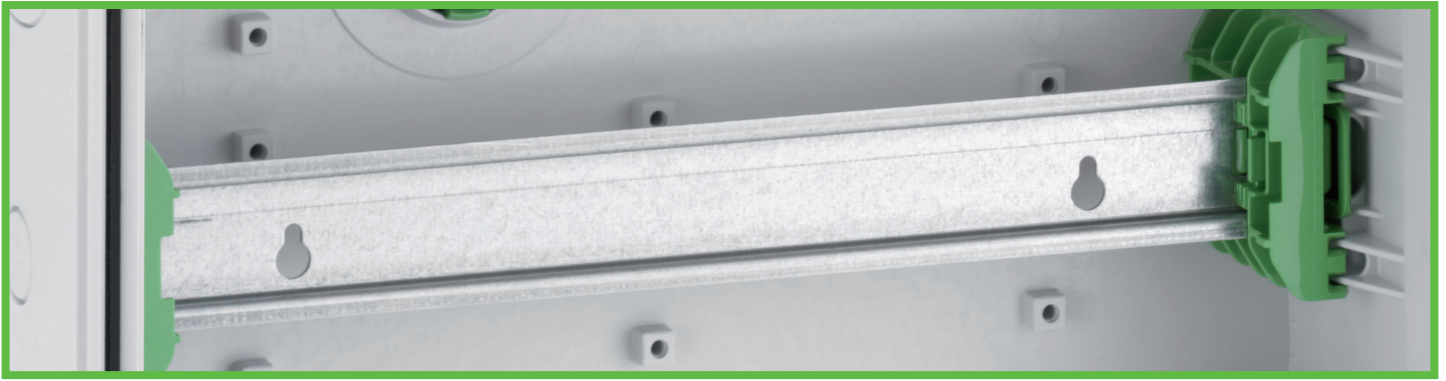

Figure 7: Standard rail on standard rail holder

The standard rail in dimensions 7.5 x 35 mm serves to accommodate the rail mounted devices. The distance between the two green standard rail holders is 14 modules (TE). (1 TE $\hat{=}$ 18 mm) number of standard rails per 14 TE

AK 14 AK-F 14	AK 28 AK-F 28	AK 42 AK-F 42	AK 56 AK-F 56	AK 70	AK-Plus 14 AK-F-Plus 14	AK-Plus 28 AK-F-Plus 28	AK-Plus 42 AK-F-Plus 42
1	2	3	4	4+1	1	2	3

Table 2: Number of standard rails

Standard rail holder

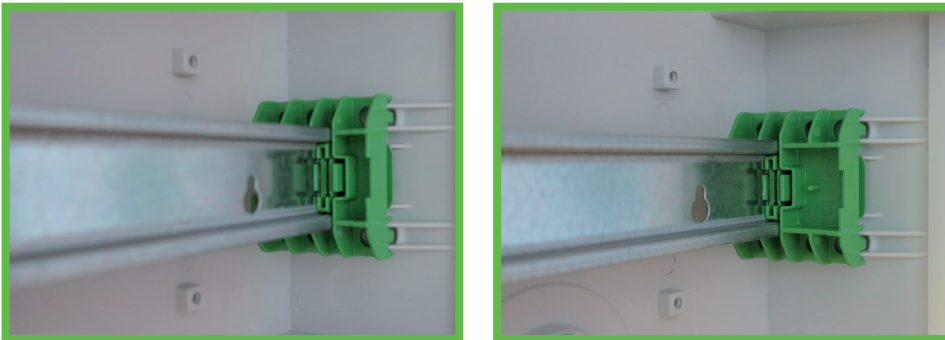

Figure 8: Standard rail holder

With the standard rail holder it is possible to use the standard rails at two heights. In the top position, as set in the factory, the distance between the standard rail and device cut-out is 50 mm. This position is suitable for all rail mounted devices in sizes 1 - 3. In the lowered position the distance increases to 62 mm.

PE/N rail

Design form: AK and AK-F

AK-Small distribution boards in design forms AK and AK-F are supplied with a pre-assembled, VDE-tested PE/N rail. Depending on the size of the AK-Small distribution board, a varying number of clamping points are provided. From 28 modules the N-rail can be separated for two N-potentials. This results in the following connection possibilities.

	Screw terminal 2.5 - 16 mm ²		Screwless clamping point 1.4 - 4 mm ²	
	N	PE	N	PE
AK 14 / AK-F 14	3	3	14	14
AK 28 / AK-F 28	1x4 or 2x3	6	1x28 or 2x14	21

	Screw terminal 2.5 - 16 mm ²		Screwless clamping point 1.4 - 4 mm ²	
	N	PE	N	PE
AK 42 / AK-F 42	1x4 or 2x3	6	1x28 or 2x14	21
AK 56 / AK-F 56	1x4 or 2x3	6	1x28 or 2x14	21
AK 70	1x4 or 2x3	6	1x28 or 2x14	21

Table 3: PE/N rail, number of clamping points

Screw terminals:

Stripped length: 13 mm
 Conductor types: single wire, rigid, flexible
 Torque: 1.6 Nm

Screwless clamping point:

Stripped length: 12 mm
 Conductor types: single wire, rigid, flexible

The requisite clamps are included in the accessories for the connection of conductors with a larger cross-section.

Design form: AK Plus and AK-F Plus

The variants AK- Plus and AK-F Plus are supplied **without** PE/N rail.

Mounting surface

Design form: AK Plus and AK-F Plus

In addition to the hinged windows, the variants AK Plus and AK-F Plus have a surface of approx. 265 x 145 mm for the installation of e.g. command status devices or measuring devices.

Ensure that the mounting points are evenly distributed.

If the equipment breaks through the cover over the mounting surface, observe changes in:

- the protection ratings
- the clearances and creepage distances
- retention of the insulation

Standard rail screwed to the floor

Design form: AK Plus and AK-F Plus

The standard rail screwed directly to the floor with the variants AK Plus and AK-F Plus has a length of 275 mm and serves to accommodate terminal blocks or equipment that does not match with the dimensions of rail mounted devices. The height of the equipment installed here must not exceed 150 mm per equipment size 3 according to DIN 43880. The maximum depth is limited to the distance between the standard rail and the top part. It is necessary to ensure a sufficient distance from the equipment on other standard rails.

Top part

The top part is bolted with the screw bosses of the box using cover screws.

The top part differs depending in the design form of the AK-Small distribution board.



Figure 9: Top part

The top part with the overlapping, all-round edge optimally protects the seal.

The cover can be easily placed on the box without bending.

The combination of box and top part creates a creepage distance of 23.5 mm, which realises a rated insulation voltage of 1000V AC or 1500V DC with a degree of contamination of 3 (EN 61439).

The top part can be secured with sealing wire if necessary.



Figure 10: Seal top part

Device cut-out

The AK-Small distribution boards have a device cut-out in the top part, in order to enable the safe operation of rail mounted devices.

Each device cut-out is designed for a maximum of 14 modules (1 TE \triangleq 18 mm).

The factory-established cut-out is 12 TE here. By breaking out the contact guard covers on the left and right, it is possible to expand the cut-out by 0.5 or 1 TE respectively.

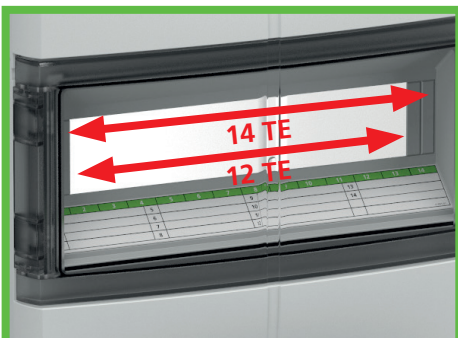

Figure 11: Device cut-out:

Hinged window

The device cut-outs are each sealed with a hinged window.
The hinged windows have an opening angle of 160°.



Figure 12: Hinged window

Each hinged window is safely locked with two snap-in hooks.
The hinged windows are opened by lightly pulling on the handle.

The hinged windows can be secured if necessary with the lock AK SGA
(same closure as AK SGA-1 or different closures AK SGA-2) or with sealing wire.

Accessories

The following assemblies are not a component of the AK-Small distribution board.

Flange / combination flange

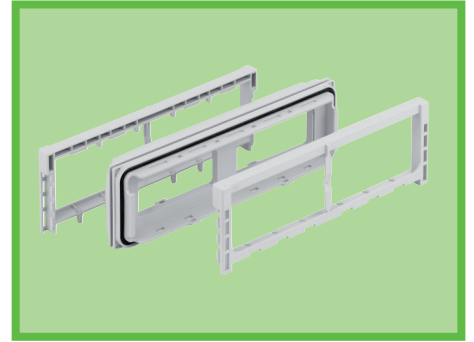
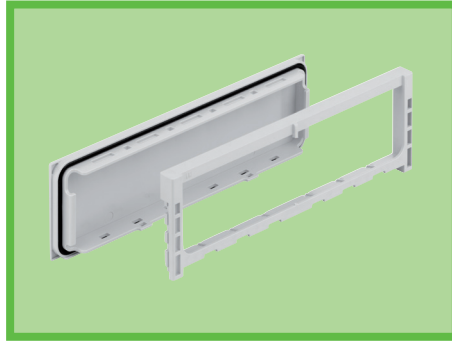
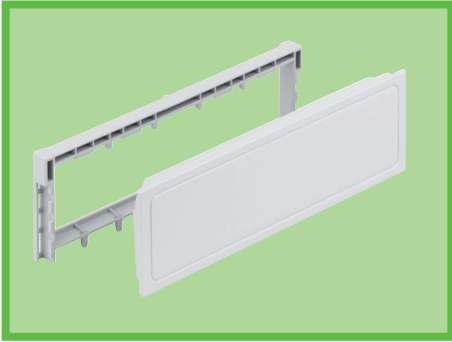

Figure 13: Flange

All AK-Small distribution boards of variant F must be closed with flanges on the top/bottom end. Spelsberg offers a wide selection of different flanges. Two AK-Small distribution boards of variant F respectively can be connected with a combination flange at the top/bottom end.

Combination screw coupling

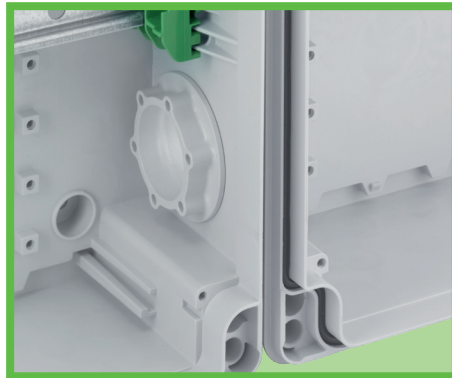

Figure 14: Combination screw coupling

The combination screw coupling connects two AK-Small distribution boards via the side walls.

Assembly plate



Figure 15: Assembly plate

The assembly plate is intended for the installation of e.g. command status devices, measuring devices. It is bolted on the mounting plugs of the box with the screws supplied (tightening torque: 2 Nm). When equipping the assembly plate, the Air® ventilation element must remain clear if possible.

Partition wall

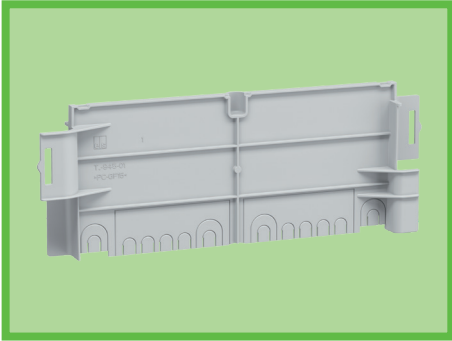

From size AK 28, the partition wall can be inserted between two opposing screw bosses of the box from the front.

Figure 16: Partition wall

Cable cover with document compartment



Figure 17: Cable cover with document compartment

The cable cover has pre-embossing on the top side for cutting out cut-outs, e.g. for a cable duct. The accommodation point for a junction box Q4 is located on the front side.

This can be used as a storage space for fine fuses or small accessory parts of the integrated devices.

The document compartment has three clamps on the rear side, in which the rolled-up documentation can be stored. Alternatively, a conventional plastic pipe M32 can be fastened in the clamps.

Standard rail with universal floor fastening

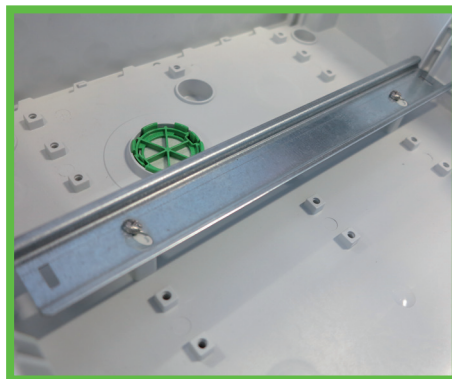
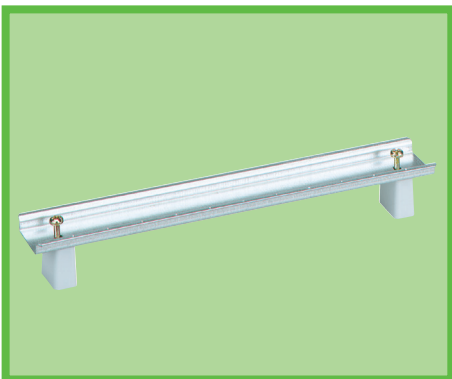

The standard rail can be mounted with the associated floor fastenings on the mounting plugs. The floor fastenings establish a distance from the back wall of 20 mm.

Figure 18: Standard rail with universal floor fastening

Mounting

Mounting the AK-Small distribution board must take place using suitable fastening material. The requisite fastening materials must be selected by the installer based on the mounting surface. In the event of wall unevenness of more than 2 mm it is necessary to level the area beneath the mounting points, in order to avoid warping the AK-Small distribution board.

Operating position

The AK-Small distribution board is designed for vertical and horizontal wall mounting, as well as horizontal floor mounting. Overhead installation is not permitted.



Figure 19: Operating position

h

Note

Operating position of equipment

The permissible operating positions of the equipment must be observed.

Fastening material

Spelsberg advises against the use of countersunk-head screws.

Mounting the box

Required fastening material: Screws, dowels, etc.

The box of the AK-Small distribution board can be mounted in three different ways:

- 3-point keyhole mounting
- Mounting with external fixing lugs
- Mounting outside the sealing area

h

Note

Rated insulation voltage

Mounting outside the sealing area:

Suitable for systems with a maximum rated insulation voltage up to 1000V AC / 1500V DC.

3-point mounting and mounting with external fixing lugs:

Suitable for systems with a rated insulation voltage up to 690V.

The PE/N terminal is designed for a rated insulation voltage of 400V AC.

Work preparation

The AK-Small distribution board has a large number of cable insertions. All cable insertions are designed for DMS double membrane seals, as well as KVR cable glands. Spelsberg recommends the use of cable glands with flexible cables.

Cable insertions

Overview of the sealing possibilities for cable insertions and the associated sealing areas.

	Cable gland KVR, IP68		Double membrane seal DMS, IP66	Stepped nipple SNI, IP55	Attachment bushes AST, IP54
Size	Sealing area [mm]	Nominal torque [mm]	Sealing area [mm]	Sealing area [mm]	Sealing area [mm]
M16	4 – 10	2.5	5 – 9	–	6 – 10
M20	6 – 12	4	7 – 12	5 – 16	8 – 13.5
M25	9 – 16	6	9 – 16	5 – 21	9 – 18.5
M32	11 – 21	7	14 – 21	13 – 26.5	13 – 23
M40	16 – 28	7.5	–	13 – 24	17 – 30
M50	32 – 44.5	9	–	–	–

Table 4: Cable insertions



Note

IP protection rating

Depending on the cable insertions used, the IP protection rating of the AK-Small distribution board reduces to the IP protection rating of the cable insertion.

Pre-embossing

All cable insertions are sealed in the factory and exhibit pre-embossing for opening.

The pre-embossing is divided up into:

- Pre-embossing with a nominal width and
- Combination pre-embossing for two nominal widths.

The pre-embossing partially exhibits a marking for knocking out.



Note

Box floor

The pre-embossing of the box floor must be knocked out before mounting. If double membrane seals are used in order to seal the cable insertions then no additional spacers are required with wall mounting.

Required tool: Hammer, flat-blade screwdriver.

Pre-embossing with marking



Figure 20: Combination pre-embossing with marking

- Insert the flat-blade screwdriver in the marking.
- Hammer the marking out.

Pre-embossing without marking and combination pre-embossing (outer nominal width)

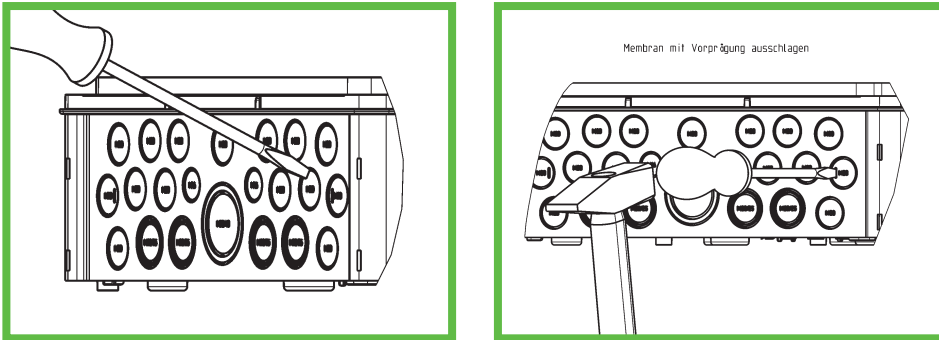

- Position the screwdriver at the marking edge, at an angle of 60 – 75° and pointing the middle point
- Hammer out the pre-embossing
- Avoid damaging the sealing contour

Cable insertion

- Insert the desired cable insertion.

Air® ventilation element

The cover of the ventilation element Air® on the rear side of the box is opened in the factory and secured with a locking mechanism. This locking mechanism can be removed with a screwdriver before wall mounting. The Air® ventilation element can be closed.



Figure 21: Air® ventilation element



Recommendation

Air® ventilation element

Spelsberg recommends only locking the ventilation element in very dusty environments with a constant temperature and air humidity.

Required tool: Screwdriver

- Using the screwdriver, break off the locking mechanism
- Turn the cover to the left until it reaches the stop
- The Air® ventilation element is closed

After removing the filter element, it is possible to discern the position of the cover from inside the box. If the locking mechanism was removed and the Air® ventilation element closed during mounting then it is possible to reopen the cover with a screwdriver.



Figure 22: Air® ventilation element closed (left) and open (right)

- Insert the screwdriver in the groove
- Turn the screwdriver to the left until it reaches the stop
- The Air® ventilation element is open

Drainage openings

The enclosure has pre-embossing in the box floor for drainage at the:

- Top/bottom ends
 - Side walls in the area of the standard rail retainers
- The drainage openings can be knocked out if necessary before or after mounting the box.



Note

IP protection rating

Opening the drainage openings reduces the distributor's protection rating.

With wall mounting with a overhead covering of 20 mm: IP43.

With mounting on a supporting frame: IP23.

The clearances and creepage distances have to be reassessed, if applicable.

If necessary, all bottom drainage openings must be opened.

If the operating position is horizontal, all drainage openings must be opened.

Required tool: Hammer, screwdriver.

- Place the screwdriver inside the box on the pre-embossing of the drainage opening
- Hammer out the pre-embossing



3-point keyhole mounting

The box is mounted via the top keyhole and the two bottom elongated holes.

Suitable fastening material:

- Elongated holes: Screws up to a maximum M6 or screws with a diameter of 5.5 mm. The screw head is permitted to have a max. diameter of 12 mm.
- Keyhole: Screws up to a maximum M5 or screws with a diameter of 5 mm. In order to use the keyhole, the screw head is permitted to have a max. diameter of 10 mm.

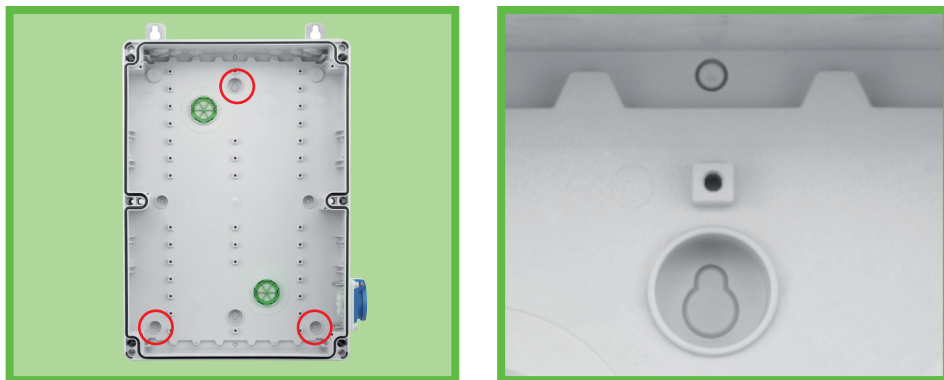

Figure 23: Fastening points 3-point mounting, keyhole fastening

Required tool: Hammer, screwdriver.

- Knock out the fastening holes
- Screw in the top screw at the desired position on the mounting wall
- Hang the box with the keyhole on the pre-mounted top screw
- Align the box
- Mark the bottom fastening points.
- Screw the screws into the bottom elongated holes
- Close all fastening holes with the sealing plugs
- The mounting process is complete

If necessary, additional fastening points can also be used

Mounting with external fixing lugs

h

Note

External fixing lugs

The external fixing lugs are not included in the scope of supply.

The box is mounted with the external fixing lugs using the stainless steel screws provided, via the four internal mountings. The external fixing lugs can be aligned vertically, diagonally or horizontally.

Suitable fastening material:

- Screws up to a maximum M8 or screws with a diameter of 8 mm.

In order to use the keyhole in the external fixing lug, the screw head is permitted a max. diameter of 15 mm.

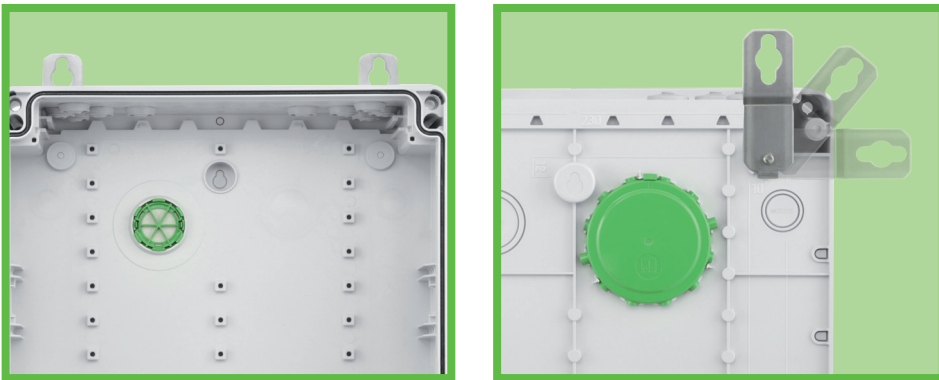

Figure 24: Fastening points, external lugs

Required tool: Hammer, screwdriver

- Knock out the fastening holes.
- Mount the fastening lugs on the fastening holes using the screws provided. The keyholes of the fastening lugs exhibit the desired position.
- Close the fastening holes with the sealing plugs.
- Screw the box to the desired position on the mounting wall using the fastening lugs. The mounting process is complete.

Mounting outside the sealing area

The box is mounted outside the sealing area using the screw bosses.

Mounting outside the sealing area is suitable with level surfaces or mounting profiles (e.g. Z-profiles). With pre-wired systems comes the advantage that no mounting work is required in the device and wiring space.

Suitable fastening material:

- Screws up to a maximum M5 or
- Screws with a diameter of 5 mm.
The screw head is permitted to have a max. diameter of 10 mm here

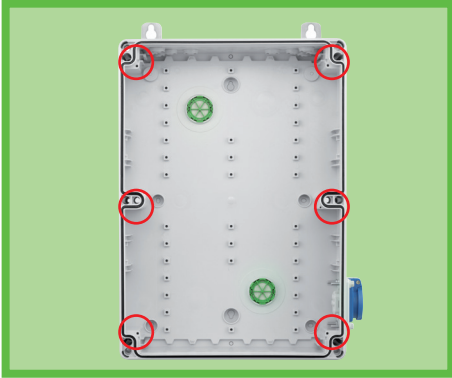

Figure 25: Fastening points outside the sealing area

Required tool: Screwdriver

- Screw the box into the desired position on the wall.
The mounting process is complete.

Standard rail

The standard rail can be equipped with rail mounted devices inside and outside the box.

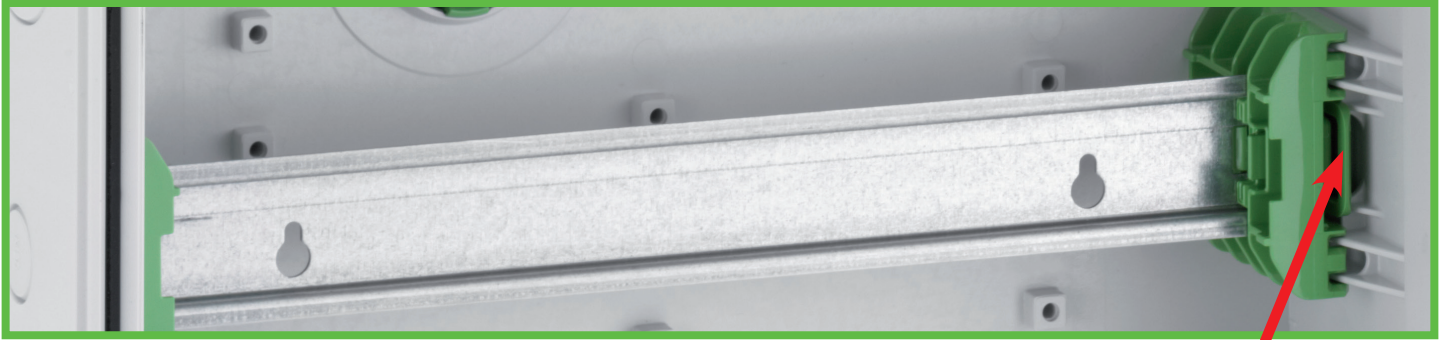

Figure 29: Standard rail

Removal of standard rails

- Lightly press the snap-in hooks of the standard rail holder towards the box middle
- Draw the standard rail together with the standard rail holders up and out of the box retainer.

Insertion of standard rails

- Slide the standard rail holder with the standard rail into the box retainer.
- The standard rail holders latch.

Snap-in hook

h

Note

Modules

When equipping the standard rail it is necessary to take into account the different number of modules. The standard rail has 14 modules. The device cut-out in the cover has 12 modules and can be expanded to 14 modules.

If the standard rail is only equipped with 12 modules analogous to the device cut-out, a rail mounted device with a module can be used as a positioning aid.

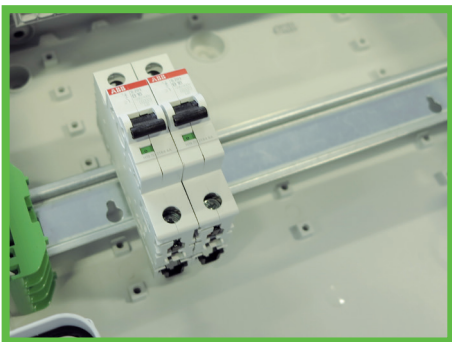

Figure 30: Standard rail

- Place the rail mounted device with one module on the standard rail, flush to the standard rail holder
- Equip the standard rail as desired
- Remove the first rail mounted device again

Standard rail holder

The standard rail holder can be used in two positions.

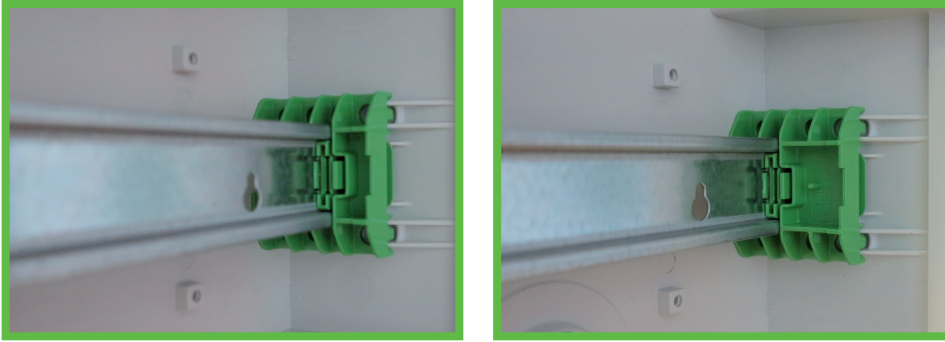

Figure 26: Snap-in hook, standard rail holder

Change position

Required tool: Screwdriver

- Remove the standard rail from the box.

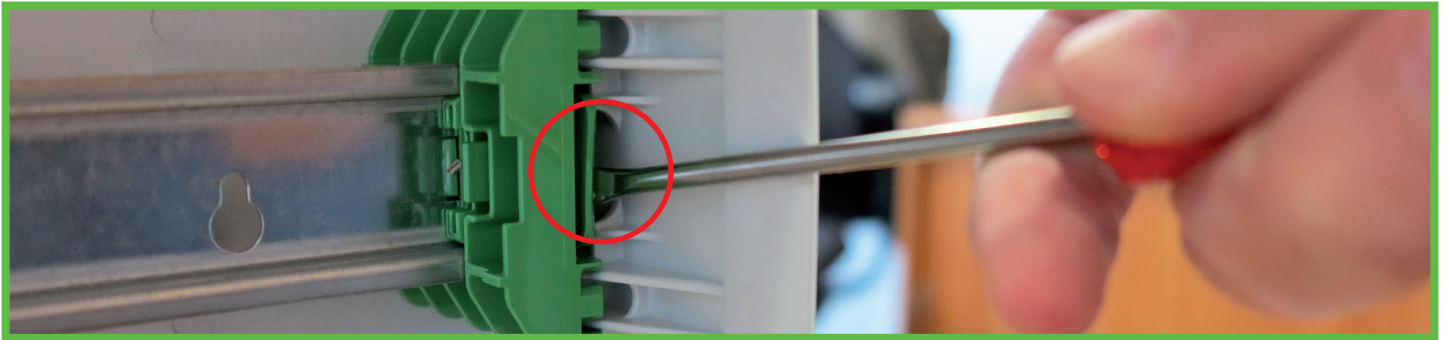

Figure 27: Press the snap-in hook inwards

The following working steps must be performed on both standard rail holders

- Using the screwdriver, disengage the snap-in hook beneath the standard rail.

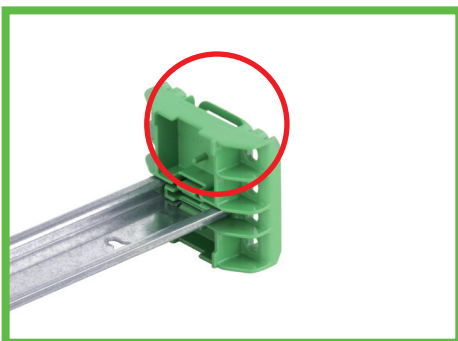

Figure 28: Snap-in hook beneath standard rail

- Draw the standard rail out of the standard rail holder
- Rotate the standard rail holder through 180°
- Slide the standard rail back into the standard rail holder
- Slide the standard rail holder with the standard rail into the box retainer
- The standard rail holders latch.

Assembly plate

The assembly plate is screwed tightly to the mounting plugs using the screws provided (tightening torque 2 Nm).

- Screw the assembly plate tightly to the mounting plugs using the screws provided.



Standard rails with universal floor fastening NS35-275

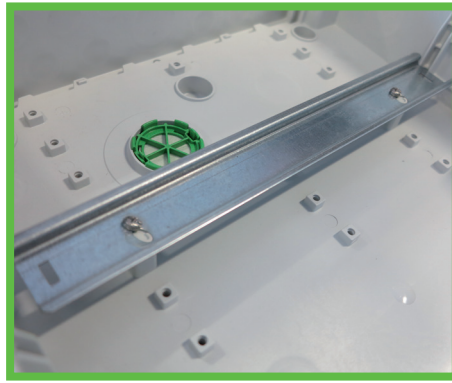
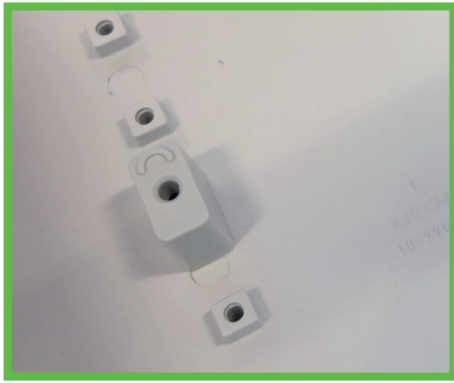

Figure 31: Universal floor fastening

Installation

Required tool: Screwdriver

- Set the universal floor fastenings, with the semi-circle pointing downwards, on the mounting plug
- Screw the screw in lightly
- Fit the standard rail with the keyholes over the screws
- Tighten the screws
- The installation process is complete

Recommended tightening torque: 1.8 Nm

Flange / flange connector



Figure 32: Flange mounting

Installation

- Insert the flange from the outside in the open top/bottom end of the box
The snap-in hooks on the floor of the box latch in place
- Press the top side of the flange against the box
- Thread the flange connector into the side guide rails of the box from the inside
- Ensure that the lower edge of the flange connector grips beneath the top edge of the flange
- Push the flange connector through to the floor
- The locking mechanisms grip into the flange and the flange connector latches in place

Removal

- Draw out the flange connector
- Push the flange out lightly from the inside
The middle strut in the flange connector, which results from the production process, can be removed if necessary

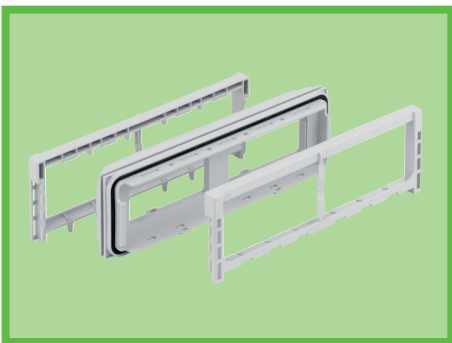

Figure 33: Middle strut

h

Note

Flange fittings

If fittings are to be mounted in the flange, which protrude more than 7 mm into the enclosure, it is only possible to fit them after the flange has been fitted. Otherwise a collision will occur when the flange connector is inserted.

Combination flange / flange connector

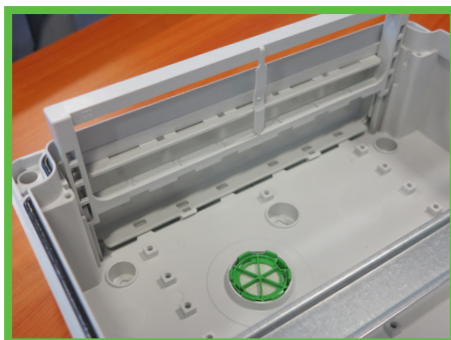

Mounting the combination flange

Installation

- Insert the combination flange from the outside in the open top/bottom end of the box
The snap-in hooks on the floor of the box latch in place
- Press the top side of the combination flange against the box
- Thread the flange connector into the side guide rails of the box from the inside
- Ensure that the lower edge of the flange connector grips beneath the top edge of the combination flange
- Push the flange connector through to the floor
The locking mechanisms grip into the combination flange and the flange connector latches in place
- Set the second box on the combination flange
The snap-in hooks on the floor of the box latch in place
- Press the top side of the combination flange against the box
- Thread the flange connector into the side guide rails of the box from the inside
- Ensure that the lower edge of the flange connector grips beneath the top edge of the combination flange
- Push the flange connector through to the floor
The locking mechanisms grip into the combination flange and the flange connector latches in place

Removal

The enclosure connection can be released by removing the flange connector inside one enclosure.

- Draw out the flange connector.
- Push the flange out lightly from the inside.



Note

Cables between the boxes

The cables between the two boxes can only be laid after connecting both boxes.

Combination screw coupling AK3 KS M50

Using the combination screw coupling it is possible to connect two AK-Small distribution boards at the side.



Figure 34: Combination screw coupling with sealing rings and seal holder

- Knock out the combination pre-embossing M50 in both boxes
- Place the two seals in the seal holder
- Push the combination screw coupling from inside through the opening of the first box
- Fit the seal holder on the combination screw coupling from the outside
- Set the second box on the combination screw coupling
- Screw the locknut onto the combination screw coupling until it is hand-tight
- The sealing rings are pressed onto the outer walls of both boxes all the way round

Partition wall AK3 TW

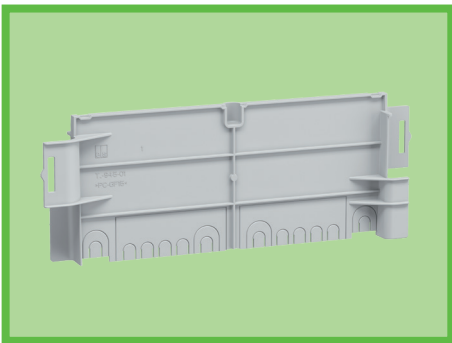

Figure 35: Partition wall with break-out openings

The partition wall has pre-embossing in the area of the floor, which can be broken out in order to feed the cables through.

- Close the fastening holes
- Break out the desired partition wall pre-embossing
- Fit the partition wall on the screw bosses from the front



Note

Fastening holes

The fastening holes in the area beneath the partition wall must be closed with sealing plugs, also if they are not used in order to mount the box.

Schuko socket AK STD

The Schuko socket is supplied with fastening screws.



- Break out the pre-embossing M50 on the box
- Drill out the fastening points in the side part ($\varnothing 6$ mm)
- Fasten the socket to the box using the mounting materials provided

Mounting the top part

Expansion of the device cut-out

The device cut-out can be expanded in half modules from 12 TE to 14 TE.

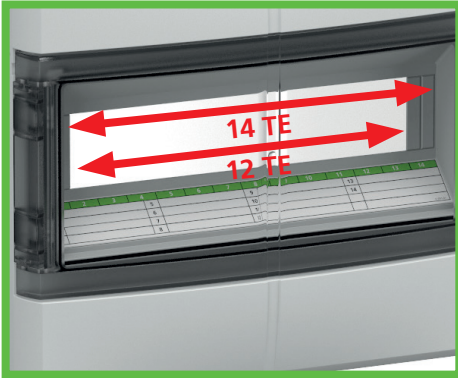

Figure 36: Partition wall with break-out openings

Required tool: e.g. combination pliers

- Break out the desired element in the direction of the box using a suitable tool.

Changing the window closure

The window is supplied as standard with hinged windows closing to the right. The closure can be changed.



Figure 37: Window closure

- Disengage the window closure by lightly pressing on both latches of the hinge on the inside of the hinged window
- Remove the hinged window together with the hinges
- Position the hinges on the opposite side of the top part in the guides intended for this purpose
- The hinges latch in place

Close window / seal



Figure 38: Closing and sealing the hinged window

Required tool: Screwdriver, hammer

- Knock out the keyhole membrane
- Insert the AK SGA lock
- Secure the lock using the split pin provided

Alternatively, the hinged window can be secured with sealing wire.

Close top part

Suitable tool: Screwdriver



Note

Opening and closing the top part should take place using a flat-blade screwdriver (blade width 4 – 6.5 mm). In order to establish leak-tightness, adhere to a tightening torque of 1.2 Nm when closing.

- Set the top part on the box
- Open the hinged window in the area of the cover screws
- Screw the top part with cover screws into the screw bosses of the box



Warning

Electric shock due to exposed live parts.

After installing the equipment it is essential to close any remaining openings in the device cut-out using the masking off strips (AK AS). When doing so, a shifting of the masking off strip in the device cut-out must not expose an opening of > 2 mm.

- Close the openings in the device cut-out.

Cable cover with document compartment



Figure 39: Cable cover with document compartment

- Fit the cable cover with the four snap-in hooks on the top of the AK-Small distribution board.
The cable cover latches into place.
- Subsequently fit the document compartment on the cable cover from the front.
The document compartment latches into place.

Maintenance

Spelsberg recommends checking the filter element and replacing it if necessary, if recurring tests arise in accordance with the national regulations. In Germany this comprises testing the guideline values for hazard and load analyses in accordance with BetriebsSichV, in conjunction with the DGUV provision 3 (previously BGV A3). With particularly dusty environments with temperature fluctuations more frequent testing should take place if necessary (e.g. in conjunction with testing the residual current devices).



Warning

Electric shock due to exposed live parts.
Observe the respective national regulations for working on active parts or in close proximity to active parts.

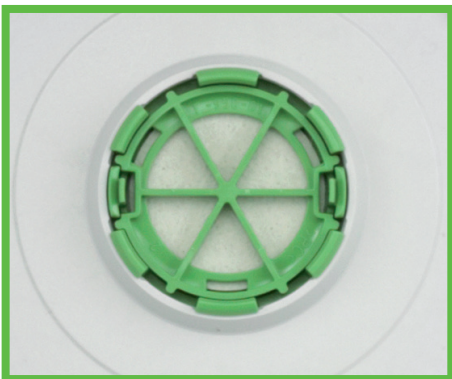

Figure 40: Filter element snap-in hooks

Suitable tool: e.g. long nose pliers

- Press the snap-in hooks inwards using the long nose pliers
- Remove the filter element
You can obtain replacement elements AK3 AIR FE on request from our sales partners or directly from Spelsberg. The replacement element consists of the new filter and the filter holder
- Insert the new filter together with the filter holder
- The filter element latches in both sides

Project planning

When which standard should be applied

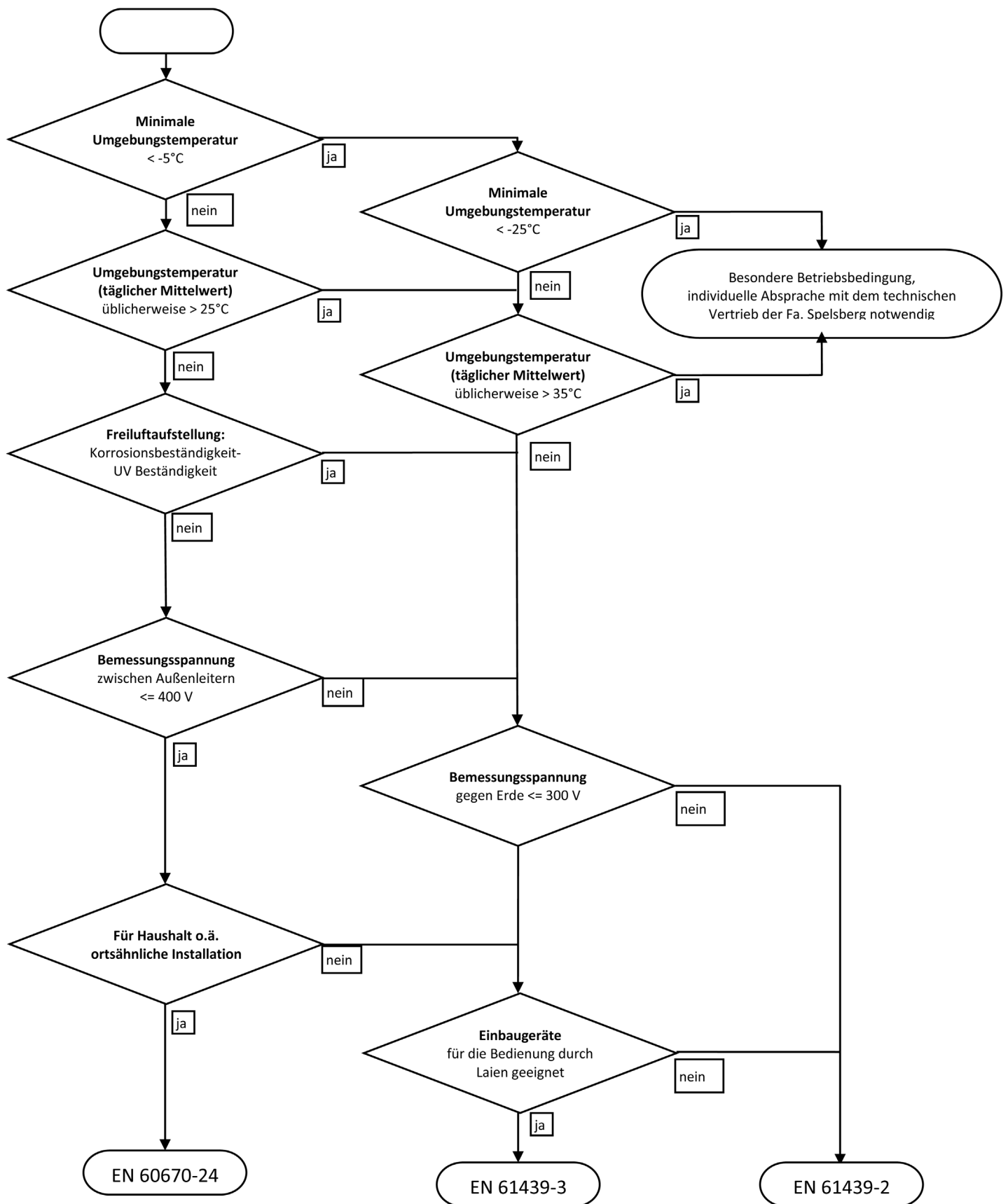

Project planning per EN 60670-24

Title of the standard

Boxes and enclosures for electrical accessories for household and similar fixed electrical installations, part 24: Special requirements for enclosures for accommodating protective devices and similar energy-consuming devices.

Application areas according to the standard



Note

Electrical characteristics

Observe the supply limits in the chapter "Electrical characteristics, page 8"

Ambient temperature

- usually +25°C
- occasionally +35°C over a period of 24 h, max. 40°C
- minimum -5°C

Classification of the AK-Small distribution board

Enclosures are classified through various criteria according to EN 60670-24 on the basis of their characteristics:

Classification criteria according to chapter 7 of EN 60670-24

The following chapter specifications in brackets refer to chapter 7 of the standard EN 60670-24. The sub-chapters relevant to the AK-Small distribution board are cited.

Type of material (chapter 7.1)

The AK-Small distribution board is an insulating material enclosure. It can be used as:

- **Empty enclosure** (divided into)
 - GP enclosure (universal enclosure)
 - PD enclosure (enclosure for predefined device equipment)
- **Basic enclosure** (divided into)
 - GP enclosure (universal enclosure)
 - PD enclosure (enclosure for predefined device equipment).

Type of installation (chapter 7.2)

The AK-Small distribution board is an enclosure for surface mounting suitable for:

- flammable walls
- flammable ceilings
- flammable floors
- flammable furniture



Note

Mounting

Observe the information in chapter "Mounting, page 22".

Types of insertions (chapter 7.3)

All cable insertions and the sealing materials, specified in the chapter "Cable insertions, page 24", of the AK-Small distribution board are suitable for:

- Sheathed cables for fixed installations
- Flexible conductors



Note

Cable glands

Spelsberg recommends the use of cable glands IP65 for flexible cables.

Fastening elements (chapter 7.4)

The AK-Small distribution board is supplied without fastening elements for cables, lines or pipes.

Minimum and maximum temperature during the installation (chapter 9.5)

The ambient temperature during installation of the AK-Small distribution board should lie within a range of -5°C to +60°C.



Note

Mounting

Observe the information in chapter "Mounting, page 22".

Protection against electric shock

With a correctly closed device cut-out, compliance with the standard protection rating IPXXC required is provided (protected against access with a tool).



Warning

Electric shock due to exposed live parts.

After installing the equipment it is essential to close any remaining openings in the device cut-out using the masking off strips (AK AS). When doing so, a shifting of the masking off strip in the device cut-out must not expose an opening of > 2 mm.

Equipment for earthing

As a fully insulated enclosure, the AK-Small distribution board is not fitted with earthing equipment. It is necessary to test the electrical conductivity of the protective earth connections inside the enclosure.

Construction

The AK-Small distribution board fulfils the requirements of the standard.

Insulation resistance and dielectric strength

The enclosure of the AK-Small distribution board has a rated insulation voltage of 1,000V AC / 1,500V DC.

Creepage distances, clearances

The AK-Small distribution board fulfils the requirements of the standard.

Verification of the maximum power output characteristics (P_{de})

The verification of heating has been conducted with AK-Small distribution boards with equivalent resistance for:

- Empty enclosure as universal enclosure (GP enclosure),
- Basic enclosure as universal enclosure (GP enclosure)

Here, the outer surface and the contact guard covers heat up by no more than 30 K.
Power losses generated per standard rail, see "Technical data, page 63".



Note

Temperature rise in the enclosure

The temperature rise inside the enclosure is higher here than the temperature rise on the outer surface and may exceed the permissible operating temperature of the equipment used.

Verification of heating

The verification of heating has been conducted with AK-Small distribution boards with combinations of equipment for:

- Empty enclosure as enclosure for predefined device configuration (PD enclosure),
- Basic enclosure as enclosure for predefined device configuration (PD enclosure).

Here, the outer surface and the contact guard covers heat up by no more than 40 K.
Power losses generated per standard rail, see "Technical data, page 63".



Note

Temperature rise in the enclosure

The temperature rise inside the enclosure is higher here than the temperature rise on the outer surface and may exceed the permissible operating temperature of the equipment used.

Design rules for use as a GP enclosure



Reference to national provisions EN 60670-24

The AK-Small distribution board cannot be used as a GP enclosure in: Germany, Greece, Belgium, France.
In the aforementioned countries, apply the design rules for use as a PD enclosure.

The design rules for use as a universal (GP) enclosure apply to empty and basic enclosures. If the design rules are observed during installation, the AK-Small distribution board fulfils the requirements of the standard.

The installation of mechanical or electrical devices in empty or basic enclosures has been verified by Spelsberg in accordance with this standard.

The installer must provide the verification information cited in this chapter for the installed devices.

Overtemperature limits



Note

Suitable AK-Small distribution board

In order to select the suitable AK-Small distribution board, the installer must prove that the measured temperature rise caused by the power loss of the installed equipment is not greater than 30 K at the hottest part of the equipped small distribution board that can be touched.

$$P_{\text{tot}} \leq P_{\text{de}}$$

With:

P_{dp} power loss of the protective equipment,

$0.2P_{\text{dp}}$ the increase of P_{dp} to account for the power loss through wiring, sockets, relays, time switches, small devices

P_{au} the power loss of installation devices other than those mentioned previously (e.g. transformers, signal lamps).

With:

P_{de} maximum power transfer capability of the enclosure in Watts [W], see "Technical data, from page 62".

P_{tot} total power loss of the electrical equipment and protective equipment installed in the enclosure, as well as the associated wiring.

$$P_{\text{tot}} = P_{\text{dp}} + 0.2P_{\text{dp}} + P_{\text{au}}$$

$$P_{\text{tot}} = 1.2P_{\text{dp}} + P_{\text{au}}$$

$$P_{dp} = \sum p_e * P_e * K_e^2 + \sum p_n * P_n * K^2$$

With:

- p_e** Number of poles of the devices in the supply circuit
- P_e** The power loss given off per pole of the devices in the supply circuit
- K_e** The loading factor for supply circuits is assumed to be 0.85
- p_e** Number of poles of the devices in the enclosure without supply circuits
- p_e** Power loss per pole of the devices in the enclosure without supply circuits
- K** Value (≤ 1) dependent on the simultaneous use of the connected loads

If no information is available regarding the actual currents and simultaneity factors, the factors in the table may be used

Number of main circuits	Loading factor K
2 and 3	0.8
4 and 5	0.7
6 to 9	0.6
10 or more	0.5

Table 6: Table AA.1 of the standard

Tests and verifications that must be performed by the installer

The equipment installed in the AK-Small distribution board must comply with the respective product standard. Follow the installation instructions of the equipment manufacturer.

Labelling

The following inscriptions must be applied:

- Name or ID of the installer,
- Type designation or other means used by the installer, in order to identify the equipped GP enclosure,
- Rated current (I_{nq}) (A),
- Rated voltage (V),
- Pictogram showing the type of power supply,
- Protection rating of the equipped GP enclosure,
- Pictogram for the insulation
- Letter N for terminals that are intended exclusively for the neutral conductor,
- Pictogram  for earthing terminals, for the connection of the protective earth conductor.

The inscriptions can also be applied behind the top part or doors of the equipped GP enclosure. The inscriptions must be permanently and highly legible. With the AK-Small distribution board with PE/N rail, the labelling required for neutral and protective earth conductor terminals is pre-stamped, the pictogram for the insulation is already printed on the top part of the AK-Small distribution board or on the sticker on the AK-Plus Small distribution board.

Protection through insulation

With the installation of equipment that breaks through the enclosure, the installer must ensure that no error voltage is conducted out of the enclosure. When installed, the equipment must be suitable for the rated insulation voltage and, if applicable, the maximum rated surge voltage.

Bodies in the equipped enclosure must not be connected with the protective earth connection.

Testing takes the form of inspection.

Electrical conductivity of the protective earth connection

The electrical conductivity of the protective earth connections must be verified for each correctly equipped, wired and mounted enclosure. Testing takes the form of an inspection and, if necessary, a test of the electrical conductivity of the protective earth connection.

Wiring, mechanical function and, if necessary, electrical function

It is necessary to check the correct positioning of the cables, effectiveness of the means of connection and correct mounting of the protective devices and other equipment.

If available, the effectiveness of the mechanical actuation elements, locking, etc.

must be tested. Depending on the complexity of the wired enclosure, an electrical function test may be required.

Testing takes the form of an inspection and, if necessary, electrical function testing.

Ageing resistance, protection against the penetration of solid foreign bodies and the harmful penetration of water

A test according to IEC 60529 must only be carried out if:

- the enclosure has been modified by the installer such that its protection rating against electric shock, as specified by the manufacturer, is affected
- the enclosure has not been installed in accordance with the manufacturer's specifications

Insulation resistance

Verification is carried out with a test device with a test voltage of at least 500 V.

The measurement takes place between each live conductor and the body, and each additional live conductor.

The measured insulation resistance must be higher than $1000 \Omega/V$, in relation to the rated voltage to ground.

This verification may be omitted in the case of single-phase equipped enclosures with a rated current of $I_{nq} \leq 32 \text{ A}$. During the test, equipment in the enclosure may be disconnected, in order to avoid damage.

Design rules for use as a PD enclosure



Reference to national provisions EN 60670-24

The AK-Small distribution board cannot be used as a PD enclosure in: Denmark, Italy.

In the aforementioned countries, apply the design rules for use as a GP enclosure.

The design rules for use as an enclosure for predefined device equipment (PD enclosure) applies to empty and basic enclosures.

Enclosures for predefined device equipment are empty or basic enclosures, for which the capacity for mechanical and electrical devices has been verified by Spelsberg according to the design rules and testing in accordance with EN 60670-24.

The AK-Small distribution board must be installed such that danger to the environment due to the equipped AK-Small distribution board heating is minimised, and correct combination of the electrical equipment is assured for the intended operation.

The following design rules constitute instructions for the installer.

The capacity for predefined mechanical or electrical devices in empty or basic enclosures has been verified by Spelsberg according to the design rules and tests in compliance with this standard. The installer must provide verification for the installed devices in accordance with the information cited in this chapter.

Rated current and main characteristics



Note

Electrical characteristics

Observe the supply limits cited in the chapter "Electrical characteristics, page 8".

The equipment with its technical data must be suitable for the planned application purpose in terms of its rated values.

The maximum operating voltage of the devices must be less than or equal to the maximum rated current of the enclosure.

The rated current of the equipment may be higher if necessary, in order to comply with an existing derating.

The maximum operating temperatures of the equipment and cables used must be taken into account.

The equipment must be arranged such that the power loss inside the AK-Small distribution board is approximately evenly distributed.



Recommendation

Power loss per standard rail

Refer to the chapter "Technical data, page 63", for the power losses that apply per standard rail.

Calculation

In order to ensure correct configuration, a calculation of the power loss given off by the installed switchgear and protective devices is required.

The electrical data required for the equipment is a component of the manufacturer's technical data.

The rated loading factors for outgoing circuits can be taken from the table for the purpose of the calculation, unless otherwise specified for the application.

Number of main circuits	Loading factor K
2 and 3	0.8
4 and 5	0.7
6 to 9	0.6
10 or more	0.5

Table 7: Table 102 of standard EN 60670-24

Equipment exists, for which the power loss is:

- a) current-independent
- b) essentially proportional to I
- c) essentially proportional to I²

The actual power loss given off is calculated for the equipment according to the formula:

$$\begin{aligned}P_{nc} &= P_n \\P_{nc} &= P_n (I_{nc} / I_n) \\P_{nc} &= P_n (I_{nc} / I_n)^2\end{aligned}$$

With:

P_{nc} Power loss with rated current of the circuit,
 I_{nc} Rated current of the circuit,
 P_n Power loss with rated current of the equipment,
 I_n Rated current of the equipment.

With outgoing circuits, it is additionally necessary to consider the loading factor (K).

With outgoing circuits the actual power loss of the equipment is calculated according to the formula:

$$\begin{aligned}\text{a)} \quad P_{nc} &= P_n * K^2 \\ \text{b)} \quad P_{nc} &= P_n (I_{nc} / I_n) * K^2 \\ \text{c)} \quad P_{nc} &= P_n (I_{nc} / I_n)^2 * K^2\end{aligned}$$

Example:

A circuit breaker B10A, which gives off a power loss of 1.5 W with a load of 10 A, gives off just 0.96 W according to the formula above with an actual rated current in the circuit of 8 A.

$$P_{nc} = 1.5 \text{ W } (8 \text{ A} / 10 \text{ A})^2 = 0.96 \text{ W}$$

If 10 circuit breakers are used in order to safeguard the outlets then according to table 101 of EN 60670-24 it is possible to assume a loading factor of 0.5. The actual power loss for an individual circuit breaker is 0.24 W.

$$P_{nc} = 1.5 \text{ W } (8 \text{ A} / 10 \text{ A})^2 = 0.96 \text{ W} * 0.5^2 = 0.24 \text{ W}$$

With 10 circuit breakers this therefore results in a total power loss of 2.4 W.

It is necessary to add to this the power loss for the wiring, which can be set at 20 % according to experience.

If a residual current device (RCD) is used in the outgoing circuit then it is not permissible to calculate using the same loading factor. The aforementioned example would result in:

10 circuit breakers B10A, loading factor 0.5

$I_{\text{RCD}} = \text{Number of devices} * \text{rated current of the equipment} * \text{loading factor}$

$I_{\text{RCD}} = 10 * 10 \text{ A} * 0.5$

$I_{\text{RCD}} = 50 \text{ A}$

In this example it would be necessary to use an RCD with a rated current of 63 A.

The actual power loss of the RCD with the rated current of 50 A would be calculated analogous to the power loss of the automatic circuit breakers:

$$P_{\text{nc}} = P_{\text{n}} (50 \text{ A} / 63 \text{ A})^2$$

Devices to be installed by the installer

The equipment installed in the AK-Small distribution board must comply with the respective product standard, e.g.:

- MCB per IEC 60898-1
- RCCB per IEC 61008-2-1
- RCBO per IEC 61009-2-1, if available

Follow the installation instructions of the equipment manufacturer.

Dimensions

The dimensions of the AK-Small distribution board differ depending on the design form, see technical data.

The distance between the standard rails is 150 mm.

The distance between the standard rail and contact guard in the cover is set to 50 mm in the factory and can be increased to 62 mm, see chapter "Standard rail holder, page 30".

The distance between the standard rail and the hinged window is set to 95 mm in the factory and can be increased to 107 mm, see chapter "Standard rail holder, page 30".

The distance between the standard rail and top/bottom end is 138 mm.

The distance between the standard rail and PE/N rail is 100 mm.

Connections

The outer conductors must be connected directly to the integrated devices installed.

Protection against electric shock

Devices must be installed and wired in the PD enclosure in accordance with the specifications of the device manufacturer, such that their faultless functionality is not affected during intended operation by:

- Heat
- Switching emissions
- Vibrations
- Magnetic fields

With PD enclosures with electronic equipment it may be necessary to lay separately or screen all electronic, signal-processing circuits.

Conductors must be selected and laid over their complete route within the PD enclosure such that no short circuit is anticipated.

IP protection rating and IK code

The AK-Small distribution board fulfils the requirements of the standard, see chapter "Protection rating, page 8".

Wiring

When installing and wiring the devices it is necessary to maintain a minimum creepage distance of 3 mm between live parts and metallic touching and non-touching parts.

The cross-sections of the conductors must concur with the installation conditions and the specifications of the device manufacturer as a minimum. The heat that arises in the enclosure must be taken into consideration here.

Project planning per EN 61439-3

Title of the standard

Low voltage switchgear combinations – part 3: Installation distributors for operation by laypersons (DBO)

Original manufacturer / switchgear combination manufacturer

The EN 61439 standards distinguish between the terms "original manufacturer" and "switchgear combination manufacturer".

Original manufacturer

Spelsberg is responsible as the "original manufacturer" for the original design of the AK-Small distribution board and has supplied the associated verifications according to the standard EN 61439-3.

Switchgear combination manufacturer

The switchgear combination manufacturer is the organisation that takes responsibility for the finished switchgear combination. This includes the standard-compliant planning and wiring of the small distribution board, incl. on the basis of the electrical framework conditions, installation environment and operability, documented through the type and unit verification.

Type verification

In the following, Spelsberg supports the generation of the type verification. It is essential to comply with the specifications set out in this product manual regarding the small distribution board mounting, the wiring and the equipment installation. Irrespective of the information set out in this product manual, the manufacturer of the switchgear combination is responsible for applying the latest valid standard and the processes defined within it. The electrical framework conditions, installation environment and operability are to be defined by the user.

Application areas according to the standard operating conditions

The AK-Small distribution board is intended for use under the following operating conditions:

Indoor installation

- Ambient temperatures of -5°C to $+40^{\circ}\text{C}$
- Although not higher than $+35^{\circ}\text{C}$ over a period of 24h
- Relative air humidity below 50 % with a maximum temperature of 40°C , with lower temperatures a higher air humidity is also permitted.

Outdoor installation

- Ambient temperatures of -25°C to $+40^{\circ}\text{C}$
- Although not higher than $+35^{\circ}\text{C}$ over a period of 24 h
- Relative air humidity of up to 100 % with a maximum temperature of $+25^{\circ}\text{C}$.

Corrosion resistance / UV radiation

The corrosion resistance of the metal parts in the enclosure has been verified in accordance with 10.2.2 of the standard, whilst resistance to UV radiation has been verified per 10.2.4.

Degree of contamination

The AK-Small distribution board has been designed for use with a degree of contamination of 3.

Maximum installation elevation

The maximum elevation of the installation site is 2000 m above sea level.

Construction requirements



Note

Electrical characteristics

Observe the supply limits cited in the chapter "Electrical characteristics, page 8".

Type verification according to section 10 of EN 61439-1/-3

The following chapter specifications in brackets refer to chapter 10 of the standard EN 61439-1/-3.

Verification provided by the original manufacturer

Corrosion resistance (chapter 10.2.2)

The metal parts inside the AK-Small distribution board pass the tests according to definition A and are suitable for installation outdoors.

Characteristics of insulating materials (chapter 10.2.3)

- The tests for verifying the heat resistance of enclosures have been passed,
- Verification of the resistance of insulating materials to exceptional heat and fire due to internal electrical effects has been provided on the basis of samples taken with a temperature at the glow wire ends of 850°C.

Resistance to ultraviolet (UV) radiation (chapter 10.2.4)

Representative sample bodies have been subjected to successful UV testing in accordance with ISO 4892-2, process A, cycle 1 with a total time of 500 h. This confirms suitability for outdoor installation.

Lifting (chapter 10.2.5)

The AK-Small distribution board is designed for vertical and horizontal wall mounting, as well as horizontal floor mounting, with the following loads:

Maximum load per standard rail: 3 kg,

Maximum load on assembly plates: 3 kg, with 4 fastening screws

Impact testing (chapter 10.2.6)

The AK-Small distribution board fulfils the impact testing requirements, see chapter "IK protection rating, page 8".

Inscriptions (chapter 10.2.7)

The inscriptions applied in the Spelsberg delta have been successfully tested for wear resistance. The labelling strips supplied with the AK-Small distribution boards and the floor-mounted type plate are not wear and water resistant.

Protection rating of enclosures (chapter 10.3)

The AK-Small distribution board complies with the specifications for outdoor installation per EN 61439, as well as the specifications for "Moist and wet areas and rooms" and "Outdoor systems" per DIN VDE 0100-737. The AK-Small distribution board fulfils IP protection rating IP65 with closed hinged windows, see chapter "IP protection rating, page 8".



Note

IP protection rating IP65

If changes, such as the installation of command and message devices in AK-Plus enclosures, are implemented then the IP protection rating must be reassessed.

Spelsberg recommends protected installation beneath a roof or similar!

Creepage distances (chapter 10.4.2)

No additional measures (e.g. cable fixing) are required with the AK-Small distribution board due to its higher rated insulation voltage. Rated insulation voltage, see chapter "Mounting, page 22".

Protection against electric shock and electrical conductivity of the protective earth circuits (chapter 10.5)

The basic protection should prevent direct contact with dangerous, active parts. With the specified IP protection rating, the AK-Small distribution board provides the requisite protection if mounted correctly.



Warning

Electric shock due to exposed live parts

After installing the equipment it is essential to close any remaining openings in the device cut-out with the masking off strips (AK AS). When doing so, a shifting of the masking off strip in the device cut-out must not expose an opening of > 2 mm.

Electrical conductivity of the connection between bodies of the switchgear combination and protective earth circuit (chapter 10.5.2)

The AK-Small distribution board as an insulated enclosure has no connection for a protective earth conductor. There is therefore no requirement to perform the test. Protection against the consequences of a fault in the switchgear combination is provided by the protective measure "insulation".

Short circuit strength of the protective earth conductor (chapter 10.5.3)

The AK-Small distribution board is intended for use in electrical networks, in which the prospective short circuit current I_{cp} does not exceed 10 kA. Alternatively, the AK-Small distribution board may be operated on a current-limiting protective device with a switch-off current of max. 17 kA. A test of the short circuit strength of the protective earth conductor is not required in this case.

Testing enclosures produced from insulating material (chapter 10.5.4)

The AK-Small distribution board is suitable for rated insulation voltages of 1,000V AC and 1,500V DC. The corresponding tests have been passed successfully.

Combinations of AK-Small distribution boards with the combination screw coupling KVR M50 or the connection flange AK KFL are also suitable for these rated insulation voltages.

External handles produced from insulating material (chapter 10.5.5)

The test point is omitted because the AK-Small distribution board does not have external handles.

Short circuit strength (chapter 10.11)

The AK-Small distribution board is intended for use in electrical networks, in which the prospective short circuit current I_{cp} does not exceed 10 kA. Alternatively, the AK-Small distribution board may be operated on a current-limiting protective device with a switch-off current of max. 17 kA.

Verification of the short circuit strength is therefore not required for the type verification.

Electromagnetic compatibility (chapter 10.12)

The AK-Small distribution board as a pure enclosure behaves in a passive manner from an EMC perspective. Protection of the installations against electromagnetic interference in the environment, as well as protection of the environment against electromagnetic interference arising in the enclosure due to the equipment is not provided.

General information (chapter 10.12 – J.9.4.1/2)

Differentiation is made between two environments in the field of EMC.

■ Environment A:

This predominantly encompasses industrial environments, whereby the power supply network is fed via a dedicated transformer.

■ Environment B:

This environment encompasses residential, retail and commercial areas, as well as small companies, which are directly connected to the national low voltage grid.

Further details can be found in EN 61439-1, Annex J.

It is not necessary to test for EMC interference strength and EMC interference emissions in complete switchgear combinations, if the following two conditions are fulfilled:

- The integrated equipment has been designed for the stipulated environment (A or B) in accordance with the applicable EMC product standard or basic generic standard.
- The internal construction and wiring is configured according to the specifications of the equipment manufacturer.

Mechanical function (chapter 10.13)

The enclosure and the hinged doors with hinge and handle have been tested for faultless mechanical function.

Verifications to be supplied by the manufacturer of the switchgear combination

Clearances (chapter 10.4.1)

The clearances between active parts are dependent on the rated surge voltage resistance (U_{imp}). This in turn is dependent on the installation area and the mains voltage, as well as the mains configuration of the electrical mains.

Protection against electric shock and electrical conductivity of the protective earth circuits (chapter 10.5)

Devices and circuits must be arranged such that their operation and maintenance are eased and the requisite protection is simultaneously assured.

Effectiveness of the protective earth conductor (chapter 10.5.1)

The effectiveness of the protective earth conductor must be verified for protection against the consequences of a fault in the switchgear combination per 10.5.2.

The effectiveness of the protective earth conductor must be verified for protection against the consequences of a fault in external circuits, which are fed from the AK-Small distribution board, per 10.5.3.

Installation of equipment (chapter 10.6)

AK-Small distribution boards are not suitable for "operations" and "removable parts" according to standard EN 61439. The AK-Small distribution board is suitable for rail mounted devices of sizes 1-3 in accordance with DIN 43871. By changing the position of the standard rail in the standard rail holder, it is also possible to install devices with differing height dimensions (see chapter "Standard rail holder, page 30").

In AK-Plus Small distribution boards it is also possible to install other equipment in the area without a device cut-out, e.g.:

- Terminal blocks
- Transformers
- Contactors

The equipment must comply with the standards applicable to it, and it must be suitable for the respective application case.

It is necessary in particular to note:

- Rated voltage
- Rated currents
- Rated frequency
- Service life
- Making and breaking capacity
- Short circuit strength

If the short circuit strength and / or breaking capacity of the installed equipment is insufficient for the loads that arise at the installation site, the equipment must be protected by current-limiting devices. It is necessary here to ensure a corresponding coordination of the equipment, in order to prevent undesired switch-offs.

The equipment installation must take place in accordance with the manufacturer's specifications.

The power loss given off by the devices causes the air in the enclosure to heat up. Temperature-sensitive equipment should therefore always be installed in the bottom area of the enclosure.

The equipment must be easily accessible for the user. Unless otherwise agreed, the standard EN 61439 defines the following specifications:

- Connections, apart from protective earth conductor connections, must be at least 0.2 m above ground level and arranged such that the cables and lines are easy to connect,
- Displays to be read off must be positioned between 0.2 and 2.2 m above the standing area of the operator.
- EMERGENCY STOP actuation elements must be positioned between 0.8 and 1.6 m above the standing area of the operator.

The unassigned modules in the device cut-out must be closed with masking off strips.

Internal electrical circuits and connections (chapter 10.7)

The cables laid inside the AK-Small distribution board must be suitable for the respective application case. The use of bare conductors is not intended in the AK-Small distribution board.

The conductors must be suitable for the rated insulation voltage, the rated current and connection to the equipment. When laying the cables it is necessary to ensure that these are not laid over sharp edges. The standard rails installed, as well as the optionally available assembly plates, are not critical here. The conductor cross-section must be selected depending on the rated current of the respective circuit (I_{nc}). The higher temperature inside the enclosure may negatively affect the current carrying capacity of the conductor.

Connections for externally in-fed conductors (chapter 10.8)

The AK-Small distribution boards are equipped with PE and N terminals. From 28 modules the N-rail can be separated for two N-potentials. For the connection possibilities see chapter "Top/bottom ends, page 15".

Insulation properties (chapter 10.9)

General information (chapter 10.9.1)

Each circuit of the switchgear combination must withstand intermittent and transient overvoltage. This must be ensured through dielectric strength testing. When doing so, disconnect the current carrying devices in the switchgear combination (e.g. windings, measuring devices, overvoltage protection devices) that would trigger a current flow with application of the test voltage. Likewise, devices that are not designed for the test voltage must also be disconnected. All further equipment must be connected.

Frequent operational dielectric strength (chapter 10.9.2)

Main circuits, as well as auxiliary and control circuits connected to the main circuit, must be tested with the following test voltages.

Rated insulation voltage U_i (conductor against conductor, AC or DC)			Test voltage (AC effective value)	Test voltage (DC)
	$U_i \leq$	60	1,000	1,415
60	$< U_i \leq$	300	1,500	2,120
300	$< U_i \leq$	690	1,890	2,670
690	$< U_i \leq$	800	2,000	2,830
800	$< U_i \leq$	1,000	2,200	3,110
1000	$< U_i \leq$	1,500	-	3,820

Table 8: Table 8 of the standard

AC or DC auxiliary circuits and control circuits that are not connected to the main circuit, must be tested with the following test voltages.

Rated insulation voltage U_i (conductor against conductor, AC or DC)			Test voltage (AC effective value)
	$< U_i \leq$	12	250
12	$< U_i \leq$	60	500
60	$< U_i$		see EN 61439-1, Table 8

Table 9: Table 9 of the standard

Further test details can be found in the standard EN 61439-1.

Surge voltage resistance (chapter 10.9.3)

The standard offers two possibilities for verification:

- Test
- Expert assessment

Expert assessment according to 10.9.3.5 takes place through measuring or checking the dimensions in the design drawings. When doing so, the clearances must exhibit at least 1.5 times the value of the data stipulated in the following table.

Rated surge voltage resistance U_{imp} [kV]	Minimum clearance [mm]	Minimum clearance x 1.5 [mm]
≤ 2.5	1.5	2.25
4.0	3.0	4.50
6.0	5.5	8.25
8.0	8.0	12.00
12.0	14.0	21.00

Through evaluation of the data of the equipment manufacturer it is necessary to verify that all installed equipment is suitable for the specified rated surge voltage resistance U_{imp} . The possibility of verification through testing must be taken from the standard where required.

Verification of heating (chapter 10.10)

The AK-Small distribution board offers the possibility of using rail mounted devices from various manufacturers. This results in a wide range of equipment variants. Spelsberg, as the original manufacturer of the switchgear combination, does not desire a limiting specification of the equipment for the switchgear manufacturer or the user. For this reason, verification of AK-Small distribution board heating must be maintained by means of the expert assessment of a switchgear combination with a single compartment.

Verification through expert assessment (chapter 10.10.4)

The process may be applied for AK-Small distribution boards in networks with a maximum frequency of 60 Hz, if the following conditions are fulfilled according to 10.10.4.2.1:

- a) The information regarding the power loss of all installed devices is available from the device manufacturers,
- b) The power loss within the AK-Small distribution board is distributed approximately evenly.
We recommend that the power losses cited in the chapter "Technical data, page 63" per standard rail are not exceeded.
- c) The rated currents of the circuits of the switchgear combination must not exceed 80 % of the conventional thermal currents in free air (I_{th}) or the rated currents of the equipment (I_n) in the circuit.
Depending on the equipment, the designation of the permanent operating current, which is conducted without overheating, may deviate. For example for contactors for the rated operating current I_e AC1, for circuit breakers I_n . The reduced rated current can lead to a reduced power loss emission.

Example

A circuit breaker B16A may be loaded with a maximum 12.8 A.

If a rated current (I_{nc}) of 16 A is required for the outgoing circuit then this circuit must be equipped with a circuit breaker B20A ($20 \text{ A} * 0.8 = 16 \text{ A}$).

Equipment exists, for which the power loss is:

- a) current-independent,
- b) essentially proportional to I ,
- c) essentially proportional to I^2 .

The actual power loss given off is calculated for:

- a) $P_{nc} = P_n$
- b) $P_{nc} = P_n (I_{nc} / I_n)$
- c) $P_{nc} = P_n (I_{nc} / I_n)^2$

With:**P_{nc}** Power loss with rated current of the circuit**I_{nc}** Rated current of the circuit**P_n** Power loss with rated current of the equipment**I_n** Rated current of the equipment

With outgoing circuits, it is additionally necessary to consider the loading factor (RDF).

With outgoing circuits the actual power loss of the equipment is calculated according to the formula:

- a) $P_{nc} = P_n \cdot K^2$
- b) $P_{nc} = P_n (I_{nc} / I_n) \cdot K^2$
- c) $P_{nc} = P_n (I_{nc} / I_n)^2 \cdot K^2$

Example:

A circuit breaker B10A, which gives off a power loss of 1.5 W with a load of 10 A, gives off just 0.96 W according to the formula above with an actual rated current in the circuit of 8 A.

$$P_{nc} = 1.5 \text{ W } (8 \text{ A} / 10 \text{ A})^2 = 0.96 \text{ W}$$

If, for example, 10 circuit breakers are now used in an AK-Small distribution board for safeguarding the outlets then according to EN 61439-3 table 101, it is possible to assume an RDF of 0.5 and the resultant actual power loss for an individual circuit breaker is:

$$P_{nc} = 1.5 \text{ W } (8 \text{ A} / 10 \text{ A})^2 = 0.96 \text{ W} \cdot 0.5^2 = 0.24 \text{ W}$$

Table 101 of EN 61439-3

If no agreement exists between the manufacturer of the DBO and the user regarding the respective load currents then the assumed load of the outgoing circuits of the DBO or a group of outgoing circuits may be determined based on the values in table 101 of EN 61439-3.

Number of main circuits	Assumed loading factor
2 and 3	0.8
4 and 5	0.7
6 to 9	0.6
10 or more	0.5

- d) The mechanical parts and the equipment installed must be arranged such that the air circulation is not significantly affected
- e) This point is not considered because the rated current of the switchgear combination is less than 200 A
- f) All conductors must exhibit a minimum cross-section corresponding with 125 % of the permissible rated current of the associated circuit

From the example:

Circuit breaker B16A, rated current (I_{nc}) 12.8 A
 Minimum cross-section for 12.8 A * 125 % = 16 A
 Circuit breaker B20A, rated current (I_{nc}) 16 A
 Minimum cross-section for 16 A * 125% = 20 A

- g) The information regarding heating depending on the power loss generated in the enclosure for the wall mounted installation of the AK-Small distribution board has been determined through testing per 10.10.4.2.2 of EN 61439-1 and is set out in the chapter "Technical data, page 63".

The power loss of all circuits that arises including the internal wiring (for calculation see Annex H of EN 61439-1) must be calculated based on the rated current of the circuits. The total installed power loss of the small distribution board is calculated by totalling the outgoing and supply circuits. When doing so it is necessary to consider that the sum total of the outgoing currents is limited to the rated current of the small distribution board.

The heating inside the small distribution board dependent on the installed power loss is expressed in the technical annex.

Example application:

1x D02 fuse element $I_n = 63$ A, 3-pole, fuse elements 50 A, in-feed

1x RCD $I_n = 63$ A, 30 mA, 4-pole

10 circuit breakers $I_n = 10$ A, 1-pole, outlets, max. rated current for each circuit $I_{nc} = 8$ A, assumed loading factor per EN 61439-3, table 101: 0.5

In addition, it is also necessary to take into consideration the wiring and connection line in the enclosure (see also Annex H of EN 61439). Example assumption with total 5 W.

No.	Equipment	I_n	P_n with I_n	I	P with I	RDF	Number	P_{ges}
1	D02 fuse element 63A, 3-pole	63 A	1.5 W	50 A	0.9 W	1	1	0.9 W
2	D02 fuse insert 50A	50 A	5 W	50 A	5 W	1.	3	15 W
3	RCD 63A, 30mA, 4-pole	63 A	12 W	50 A	7.6 W	1.	1	7.6 W
4	Circuit breaker 10A, 1-pole	10 A	1.5 W	8 A	0.96 W	0.5	10	2.4 W
5	Line							5 W
								30.9 W

As such, a total power of 30.9 W is fed into the enclosure. With an AK 28 the temperature would increase by 30 K in the upper third, and with an AK 42 by 25 K. Together with the ambient temperature of the small distribution board, this results in the total internal temperature. The installed devices must be suitable for this temperature.

Electromagnetic compatibility (chapter 10.12)

Resistance to interference (chapter 10.12 – J.9.4.4)

Under normal operating conditions the AK-Small distribution board, in which no electronic equipment is installed, is not sensitive to electromagnetic interference. In this case a resistance to interference test per EN 61439-1 is not required. In other cases it may be necessary to test the electromagnetic compatibility in accordance with EN 61439-1, Annex J.10.12.

Interference emissions (chapter 10.12 – J.9.4.4)

With AK-Small distribution boards, which contain no electronic circuits, verification per EN 61439-1 is unnecessary. In other cases it may be necessary to test the electromagnetic compatibility in accordance with EN 61439-1, Annex J.10.12.

Unit verification according to section 11 of EN 61439-1/-3

Unit verification must be performed on all switchgear combinations and serves to determine material and production faults, as well as ensuring correct functionality.

Template for unit verification per EN 61439-3

The following template for unit verification is based on an unmodified enclosure, as well as the use of cable insertions with a protection rating of min. IP65. The information for the minimum dimensions of the clearance and creepage distances, as well as the insulation properties, is based on the following data:

- Overvoltage category: II (load level)
- Power supply system: 4-conductor 3-phase system, middle point earthed
- Rated voltage of the power supply system U_n [V]: 400V AC
- Rated insulation voltage U_i [V]: 400V AC
- Rated current of the switchgear combination I_n [A]: max. 125 A

Unit verification per EN 61439-3				
No.	Test type	Tests	yes	n/a*
11.2	S	Sheath protection type		
		IP65		
11.3	S / E	Clearances and creepage distances		
		Clearances through surge voltage testing with 5.1 kV ACeff (1.2/50 μ s) if clearances < 4.5 mm, otherwise electr. testing of creepage distances through visual inspection: 6.3 mm		
11.4	S / E	Protection against electric shock and electrical conductivity of the protective earth circuits		
		Protection against direct contact with active parts, electrical conductivity of the protective earth conductor (resistance measurement with min. 10 A, max. 0.1 Ω)		
11.5	V	Installation of equipment		
		Concordance with the circuit documents and other documents, identification and labelling, completeness of the user and service documents		
11.6	M	Internal connections		
		Check screwed connections on a random sampling basis for the correct tightening torque		
	E	Internal electrical circuits		
		Faultless wiring in concordance with the circuit documents		
11.7	V	Connections for externally in-fed conductors		
		Connection, type and identification of connections must agree with the production documents		
11.8	M	Mechanical function		
		Check mechanical actuation elements, locking mechanisms and seals		
11.9	E	Insulation characteristics		
		Measurement of insulation resistance with 500V DC between circuits and bodies: $R > 400$ kOhm		
11.10	S / E	Wiring, operating behaviour, function		
		Checking labelling, wiring electrical function testing		

* n/a =not assessable

Test types: S = Visual inspection

E = Electrical testing

Unit verification per EN 61439-3

M = Mechanical testing

V = Comparison with production documents

Project planning per EN 61439-2

Title of the standard

Low-voltage switchgear combinations

The application of the AK-Small distribution board as an energy switchgear combination may be necessary, if the application of voltages up to 1000V AC or 1500V DC is required.

The type verification and unit verification must be maintained analogous to the chapter "Project planning per EN 61439-3, page 52".

In deviation, it is also necessary to observe points including the following:

Installation of equipment (chapter 10.6)

It is only permissible to use devices that can be operated by laypersons. If devices are used that can only be operated by specialist personnel, access to these devices must be prevented by suitable measures (e.g. through the installation of the lock AK-SGA in the hinged window or sealing the hinged window).

Verification of heating (chapter 10.10)

The assumed loading factors per table 101 in EN 61439-2 differ from table 101 in EN61439-3.

Table 101 of EN 61439-2

If no agreement exists between the manufacturer of the switchgear combination and the user regarding the respective load currents then the assumed load of the outgoing circuits of the DBO or a group of outgoing circuits may be determined based on the values in table 101 of EN 61439-2.

Type of loading	Assumed loading factor
Energy distribution 2 and 3 circuits	0.9
Energy distribution 4 and 5 circuits	0.8
Energy distribution 6 to 9 circuits	0.7
Energy distribution 10 or more circuits	0.6
Position actuator	0.2
Motors ≤ 100 kW	0.8
Motors > 100 kW	1.0

Table 12: Table 101 of EN 61439-2

Annex

Technical data

The data pertains to the enclosure without PE/N terminals.

AK-Small Distribution Board

Product name	AK 14	AK 28	AK 42	AK 56	AK 70
Article number	733 414 01	733 428 01	733 442 01	733 456 01	733 570 01
Rated voltage	400V	400V	400V	400V	400V
Rated current	125A	125A	125A	125A	125A
Weight / unit [kg]	2.62	3.76	5.45	6.08	10.2
Length [mm]	300	450	600	750	1050
Width [mm]	315	315	315	315	315
Height [mm]	155	155	155	155	155
Internal height [mm]	95	95	95	95	95
Internal width [mm]	295	295	295	295	295
Internal length [mm]	280	430	580	730	880
Box material	PC GF	PC GF	PC GF	PC GF	PC GF
Cover material	PC	PC	PC	PC	PC
Hinged window material	PC transparent	PC transparent	PC transparent	PC transparent	PC transparent
Seal material	PU	PU	PU	PU	PU
Cover screw material	PA6GF	PA6GF	PA6GF	PA6GF	PA6GF
Protection type	IP65	IP65	IP65	IP65	IP65
IK* (front, side)	08	08	08	08	08
IK* (top/bottom end, flange with AK FL01)	07	07	07	07	07
Colour	grey, simil. RAL 7035	grey, simil. RAL 7035	grey, simil. RAL 7035	grey, simil. RAL 7035	grey, simil. RAL 7035
stackable	yes	yes	yes	yes	yes
Ambient temp. min. [°C]	-25	-25	-25	-25	-25
Ambient temp. max [°C]	40	40	40	40	40
Ambient temp. 24h [°C]	35	35	35	35	35
max. rel. humidity 25°C	90%	90%	90%	90%	90%
max. rel. humidity 40°C	50%	50%	50%	50%	50%
Halogen-free	yes	yes	yes	yes	yes
Heavy metal-free	yes	yes	yes	yes	yes
PVC-free	yes	yes	yes	yes	yes
Silicone-free	yes	yes	yes	yes	yes
Sealable	yes	yes	yes	yes	yes
Standards	EN60670-24 EN 61439-2/3	EN60670-24 EN 61439-2/3	EN60670-24 EN 61439-2/3	EN60670-24 EN 61439-2/3	EN60670-24 EN 61439-2/3
Max. power output capacity (Pde) For GP enclosure in acc. with EN 60670-24 [per standard rail]*	26W [26W]	35W [17.5W]	45W [15W]	56W [14W]	66W [13W]
Achievable power loss in PD enclosure in acc. with EN 60670-24 [per standard rail]*	35W [35W]	48W [24W]	62W [20W]	77W [19W]	90W [18W]
Power loss output capacity in acc. with EN 61439-1, 10.10.4.2.2 [per standard rail]*	19W [19W]	21W [10.5W]	24W [8W]	28W [7W]	31W [6W]

Table 13: AK Small Distribution Board

*Note: Data applies to a vertical operating position

AK-F Small Distribution Board

Product name	AK-F 14	AK-F 28	AK-F 42	AK-F 56
Article number	733 514 01	733 528 01	733 542 01	733 556 01
Rated voltage	400V	400V	400V	400V
Rated current	125A	125A	125A	125A
Weight / unit [kg]	2.62	3.76	5.45	6.08
Length [mm]	300	450	600	750
Width [mm]	315	315	315	315
Height [mm]	155	155	155	155
Internal height [mm]	95	95	95	95
Internal width [mm]	295	295	295	295
Internal length [mm]	280	430	580	730
Box material	PC GF	PC GF	PC GF	PC GF
Top part material	PC	PC	PC	PC
Hinged window material	PC transparent	PC transparent	PC transparent	PC transparent
Seal material	PU	PU	PU	PU
Cover screw material	PA6GF	PA6GF	PA6GF	PA6GF
Protection type	IP65	IP65	IP65	IP65
IK* (front, side)	08	08	08	08
IK* (top/bottom end, flange with AK FL01)	07	07	07	07
Colour	grey, simil. RAL 7035	grey, simil. RAL 7035	grey, simil. RAL 7035	grey, simil. RAL 7035
stackable	yes	yes	yes	yes
Ambient temp. min. [°C]	-25	-25	-25	-25
Ambient temp. max [°C]	40	40	40	40
Ambient temp. 24h [°C]	35	35	35	35
max. rel. humidity 25°C	90%	90%	90%	90%
max. rel. humidity 40°C	50%	50%	50%	50%
Halogen-free	yes	yes	yes	yes
Heavy metal-free	yes	yes	yes	yes
PVC-free	yes	yes	yes	yes
Silicone-free	yes	yes	yes	yes
Sealable	yes	yes	yes	yes
Standards	EN60670-24 EN 61439-2/3	EN60670-24 EN 61439-2/3	EN60670-24 EN 61439-2/3	EN60670-24 EN 61439-2/3
Max. power output capacity (Pde) For GP enclosure in acc. with EN 60670-24 [per standard rail]	26W [26W]	35W [17.5W]	45W [15W]	56W [14W]
Achievable power loss in PD enclosure in acc. with EN 60670-24 [per standard rail]	35W [35W]	48W [24W]	62W [20W]	77W [19W]
Power loss output capacity in acc. with EN 61439-1, 10.10.4.2.2 [per standard rail]	19W [19W]	21W [10.5W]	24W [8W]	28W [7W]

Table 14: AK-F Small Distribution Board

AK-Plus-Small Distribution Board

Product name	AK 14 Plus	AK 28 Plus	AK 42 Plus
Article number	733 614 01	733 628 01	733 642 01
Rated voltage	400V	400V	400V
Rated current	125A	125A	125A
Weight / unit [kg]	3.26	5.49	6.28
Length [mm]	450	600	750
Width [mm]	315	315	315
Height [mm]	155	155	155
Internal height [mm]	95	95	95
Internal width [mm]	295	295	295
Internal length [mm]	280	430	580
Box material	PC GF	PC GF	PC GF
Top part material	PC	PC	PC
Hinged window material	PC transparent	PC transparent	PC transparent
Seal material	PU	PU	PU
Cover screw material	PA6GF	PA6GF	PA6GF
Protection type	IP65	IP65	IP65
IK* (front, side)	08	08	08
IK* (top/bottom end, flange with AK FL01)	07	07	07
Colour	grey, simil. RAL 7035	grey, simil. RAL 7035	grey, simil. RAL 7035
stackable	yes	yes	yes
Ambient temp. min. [°C]	-25	-25	-25
Ambient temp. max [°C]	40	40	40
Ambient temp. 24h [°C]	35	35	35
max. rel. humidity 25°C	90%	90%	90%
max. rel. humidity 40°C	50%	50%	50%
Halogen-free	yes	yes	yes
Heavy metal-free	yes	yes	yes
PVC-free	yes	yes	yes
Silicone-free	yes	yes	yes
Sealable	yes	yes	yes
Standards	EN60670-24 EN 61439-2/3	EN60670-24 EN 61439-2/3	EN60670-24 EN 61439-2/3
Max. power output capacity (Pde) For GP enclosure in acc. with EN 60670-24 [per standard rail]	52W [52W]	61W [30.5W]	70W [23W]
Achievable power loss in PD enclosure in acc. with EN 60670-24 [per standard rail]	70W [70W]	92W [46W]	113W [36.5W]
Power loss output capacity in acc. with EN 61439-1, 10.10.4.2.2 [per standard rail]	25W [25W]	27W [13.5W]	30W [10W]

Table 15: AK-F Small Distribution Board

AK-F-Plus Small Distribution Board

Product name	AK-F 14 Plus	AK-F 28 Plus	AK-F 42 Plus
Article number	733 714 01	733 728 01	733 742 01
Rated voltage	400V	400V	400V
Rated current	125A	125A	125A
Weight / unit [kg]	3.26	5.49	6.28
Length [mm]	450	600	750
Width [mm]	315	315	315
Height [mm]	155	155	155
Internal height [mm]	95	95	95
Internal width [mm]	295	295	295
Internal length [mm]	280	430	580
Box material	PC GF	PC GF	PC GF
Top part material	PC	PC	PC
Hinged window material	PC transparent	PC transparent	PC transparent
Seal material	PU	PU	PU
Cover screw material	PA6GF	PA6GF	PA6GF
Protection type	IP65	IP65	IP65
IK* (front, side)	08	08	08
IK* (top/bottom end, flange with AK FL01)	07	07	07
Colour	grey, simil. RAL 7035	grey, simil. RAL 7035	grey, simil. RAL 7035
stackable	yes	yes	yes
Ambient temp. min. [°C]	-25	-25	-25
Ambient temp. max [°C]	40	40	40
Ambient temp. 24h [°C]	35	35	35
max. rel. humidity 25°C	90%	90%	90%
max. rel. humidity 40°C	50%	50%	50%
Halogen-free	yes	yes	yes
Heavy metal-free	yes	yes	yes
PVC-free	yes	yes	yes
Silicone-free	yes	yes	yes
Sealable	yes	yes	yes
Standards	EN60670-24 EN 61439-2/3	EN60670-24 EN 61439-2/3	EN60670-24 EN 61439-2/3
Max. power output capacity (Pde) For GP enclosure in acc. with EN 60670-24 [per standard rail]	52W [52W]	61W [30.5W]	70W [23W]
Achievable power loss in PD enclosure in acc. with EN 60670-24 [per standard rail]	70W [70W]	92W [46W]	113W [36.5W]
Power loss output capacity in acc. with EN 61439-1, 10.10.4.2.2 [per standard rail]	25W [25W]	27W [13.5W]	30W [10W]

Table 16: AK-F-Plus Small Distribution Board

AK / AK-F Small Distribution Board

Product name	AK 14 L-g	AK 14 L-t	AK-F 14 L-g	AK-F 14 L-t
Article number	73341001	73341101	73351001	73351101
Rated voltage	400V	400V	400V	400V
Rated current	125A	125A	125A	125A
Weight / unit [kg]	2.4	2.4	2.4	2.4
Length [mm]	300	300	300	300
Width [mm]	315	315	315	315
Height [mm]	147	147	147	147
Internal height [mm]	112	112	112	112
Internal width [mm]	295	295	295	295
Internal length [mm]	280	280	280	280
Box material	PC GF	PC GF	PC GF	PC GF
Top part material	PC	PC	PC	PC
Hinged window material	--	--	--	--
Seal material	PU	PU	PU	PU
Cover screw material	PA6GF	PA6GF	PA6GF	PA6GF
Protection type	IP65	IP65	IP65	IP65
IK* (front, side)	8	8	8	8
IK* (top/bottom end, flange with AK FL01)	7	7	7	7
Colour	grey, simil. RAL 7035	grey, simil. RAL 7035	grey, simil. RAL 7035	grey, simil. RAL 7035
stackable	yes	yes	yes	yes
Ambient temp. min. [°C]	-25	-25	-25	-25
Ambient temp. max [°C]	40	40	40	40
Ambient temp. 24h [°C]	35	35	35	35
max. rel. humidity 25°C	90%	90%	90%	90%
max. rel. humidity 40°C	50%	50%	50%	50%
Halogen-free	yes	yes	yes	yes
Heavy metal-free	yes	yes	yes	yes
PVC-free	yes	yes	yes	yes
Silicone-free	yes	yes	yes	yes
Sealable	yes	yes	yes	yes
Standards	EN60670-24 EN 61439-2/3	EN60670-24 EN 61439-2/3	EN60670-24 EN 61439-2/3	EN60670-24 EN 61439-2/3
Max. power output capacity (Pde) For GP enclosure in acc. with EN 60670-24 [per standard rail]	26W [26W]	26W [26W]	26W [26W]	26W [26W]
Achievable power loss in PD enclosure in acc. with EN 60670-24 [per standard rail]	35W [35W]	35W [35W]	35W [35W]	35W [35W]
Power loss output capacity in acc. with EN 61439-1, 10.10.4.2.2 [per standard rail]	19W [19W]	19W [19W]	19W [19W]	19W [19W]

Table 17: AK / AK-F Small Distribution Board

Dimensioned drawing

AK 14 / AK 14-F

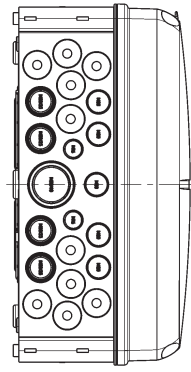
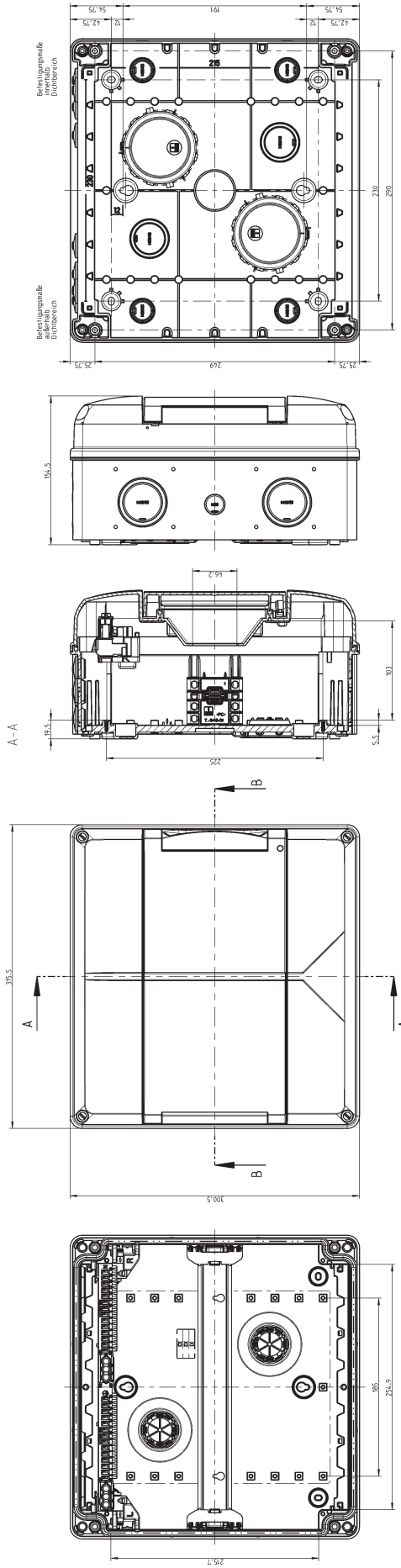
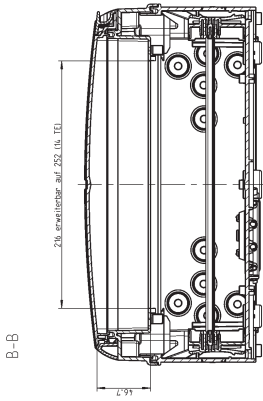
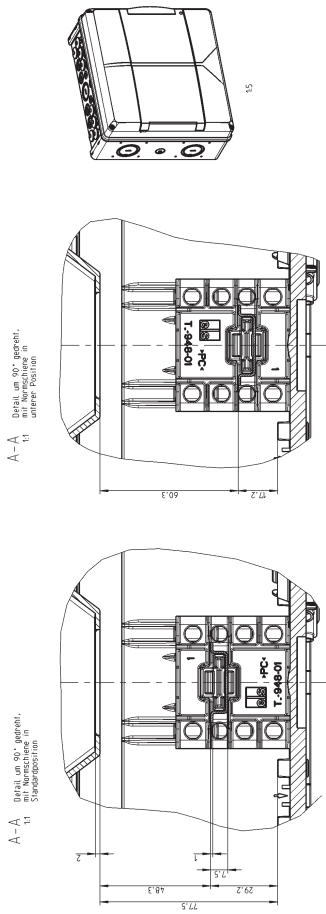

Dimensioned drawing

AK 28 / AK 28-F

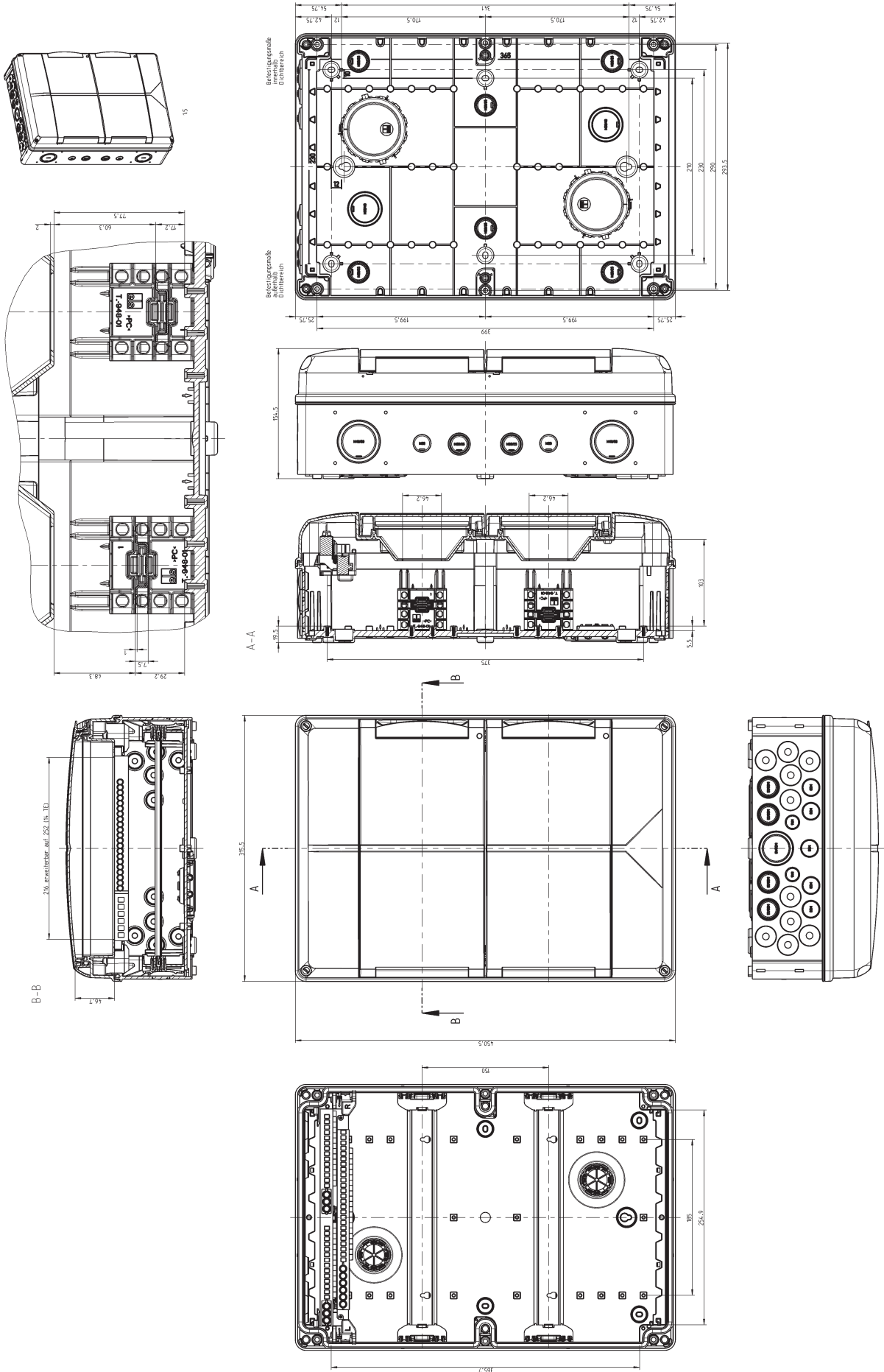

Dimensioned drawing

AK 42 / AK 42-F

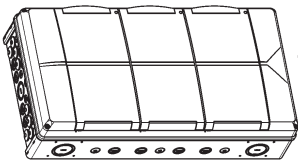

15

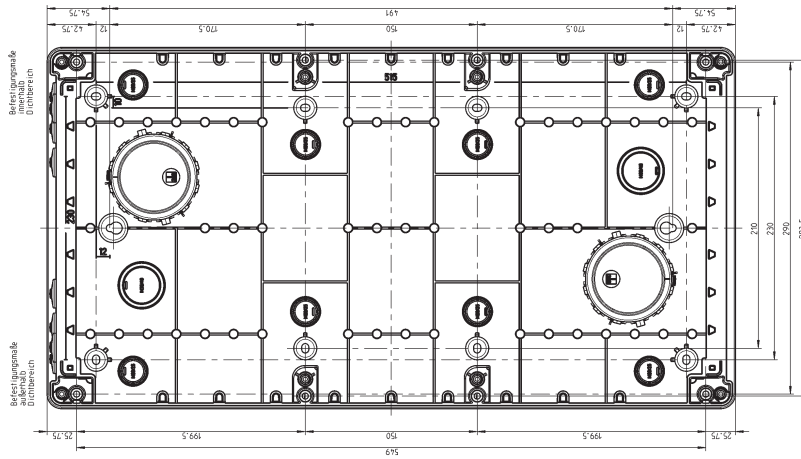

Belegungsmaße
Drückerbereich

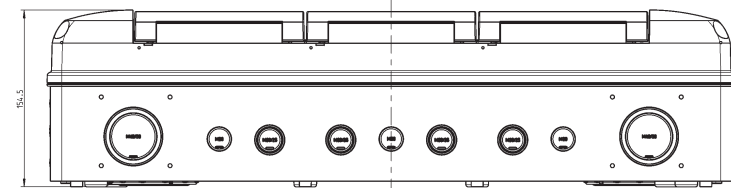

A-A

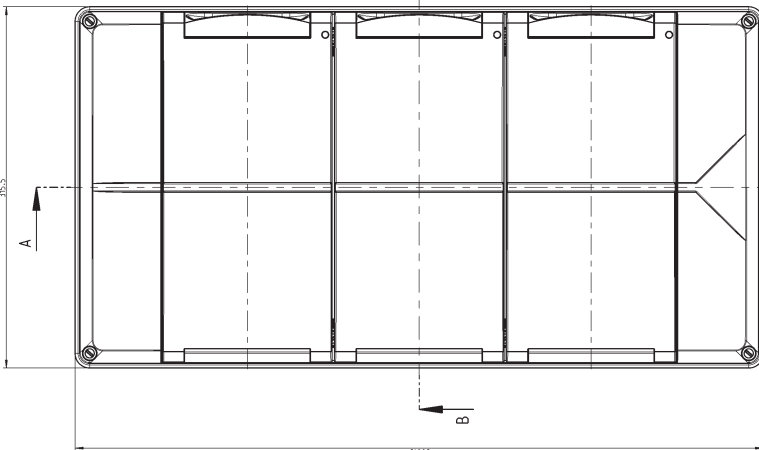
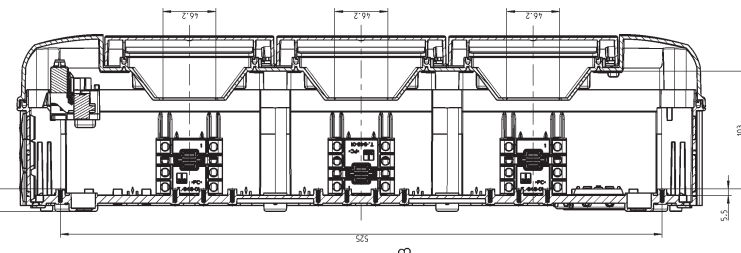

A

B

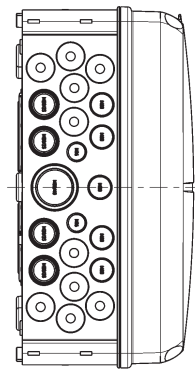

A

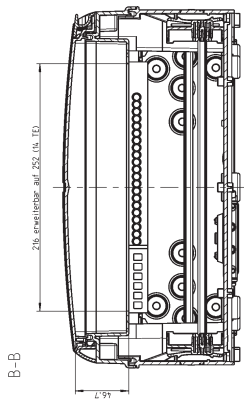

B-B

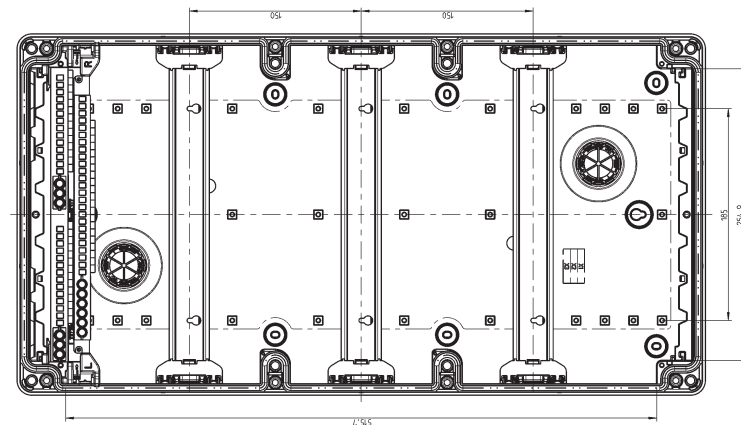

B

Dimensioned drawing

AK 56 / AK 56-F

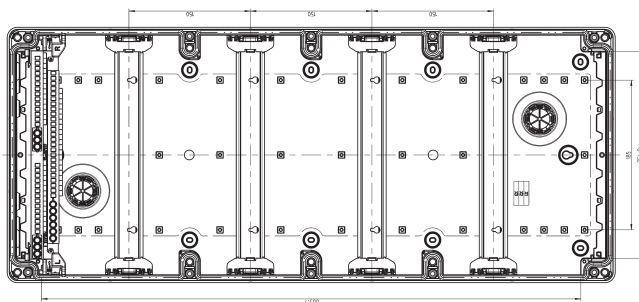
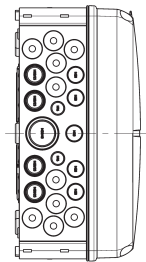
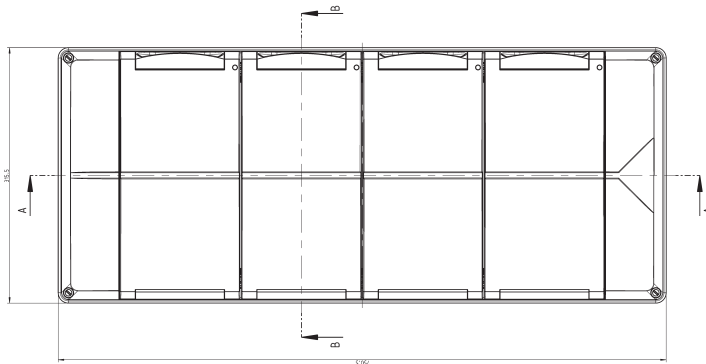
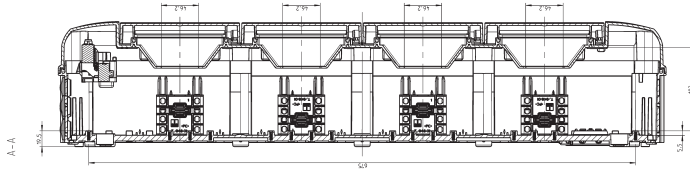
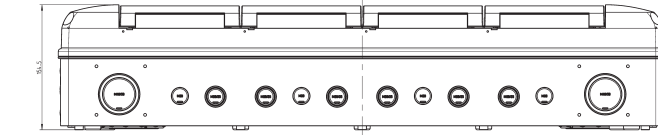
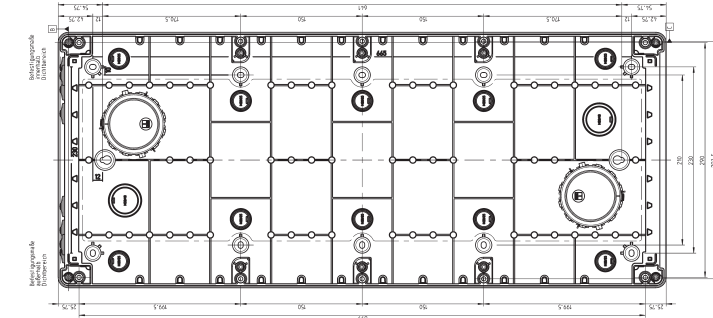
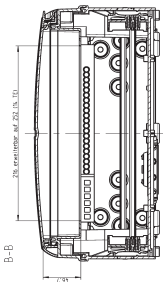
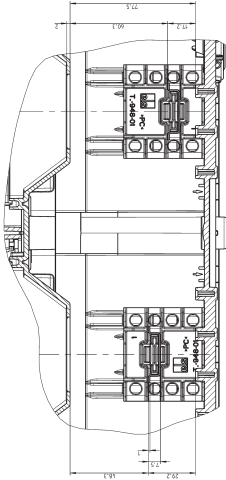
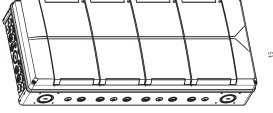

Dimensioned drawing

AK 70

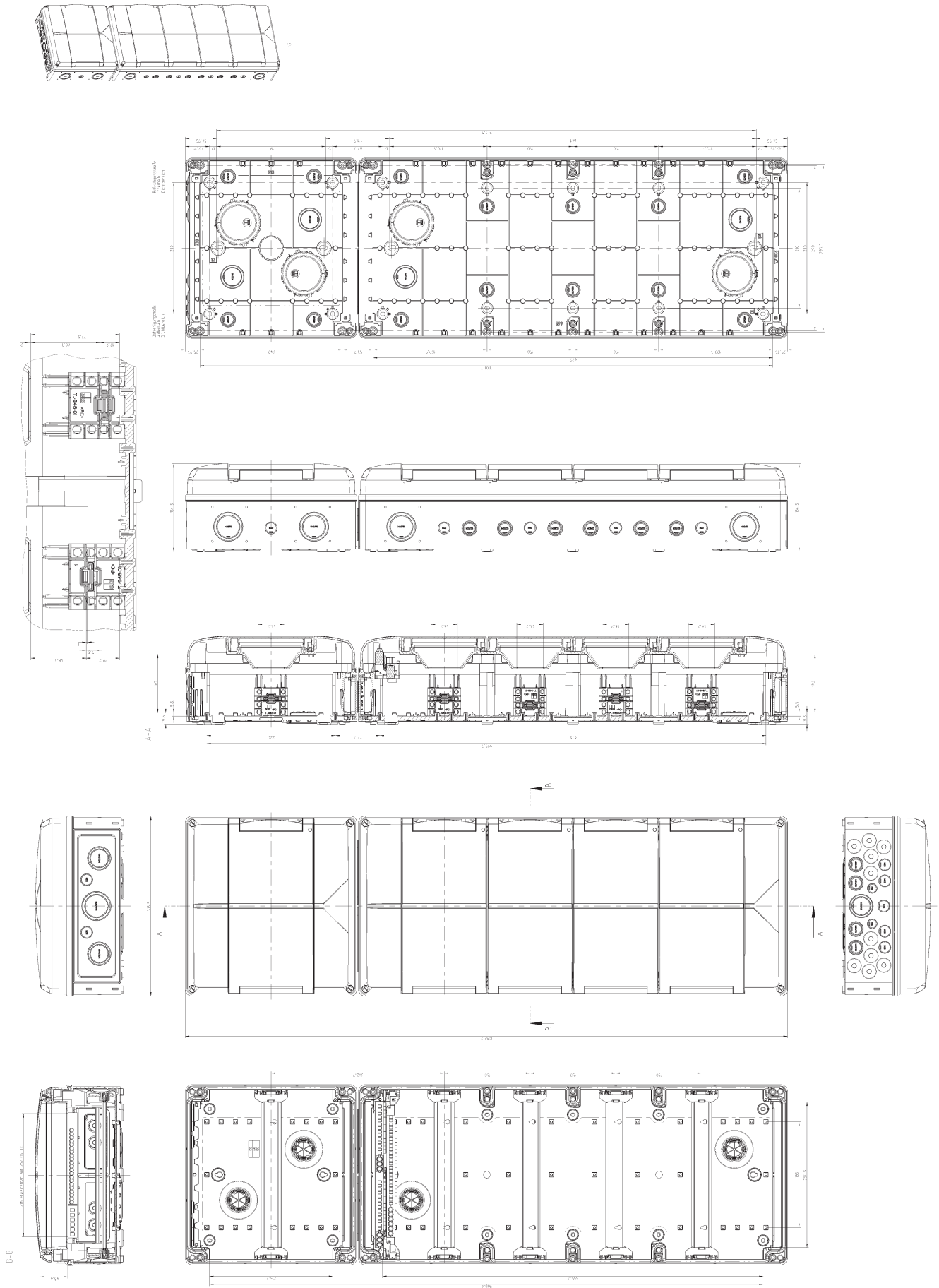

VDE Prüf- und Zertifizierungsinstitut

ZEICHENGENEHMIGUNG MARKS APPROVAL

Günther Spelsberg GmbH & Co. KG
Im Gewerbepark 1
58579 Schalksmühle

ist berechtigt, für ihr Produkt /
is authorized to use for their product

**Gehäuse zur Aufnahme von Schutzgeräten und ähnlichen
energieverbrauchenden Geräten**

***Enclosures for housing protective devices and other power dissipating
electrical equipment***

die hier abgebildeten markenrechtlich geschützten Zeichen
für die ab Blatt 2 aufgeführten Typen zu benutzen /
the legally protected Marks as shown below for the types referred to on page 2 ff.



Geprüft und zertifiziert nach /
Tested and certified according to

DIN EN 60670-1 (VDE 0606-1):2014-01; EN 60670-1:2005+A1:2013
DIN EN 60670-24 (VDE 0606-24):2014-03; EN 60670-24:2013



VDE Prüf- und Zertifizierungsinstitut GmbH
VDE Testing and Certification Institute
Zertifizierungsstelle / Certification

Dr. Schipper

Aktenzeichen: 292300-1410-0057 / 201191
File ref.:

Ausweis-Nr. 40041740

Blatt 1
Page

Certificate No.
Weitere Bedingungen siehe Rückseite und Folgeblätter /
further conditions see overleaf and following pages

Offenbach, 2015-02-24

(letzte Änderung / updated 2015-03-12)

VDE Zertifikate sind nur gültig bei Veröffentlichung unter:
VDE certificates are valid only when published on:

<http://www.vde.com/zertifikat>
<http://www.vde.com/certificate>

VDE



DLG-Prüfbericht 6228 F

G. Spelsberg GmbH & Co. KG

Installations-Kleinverteiler Serie AK III

Ammoniakbeständigkeit

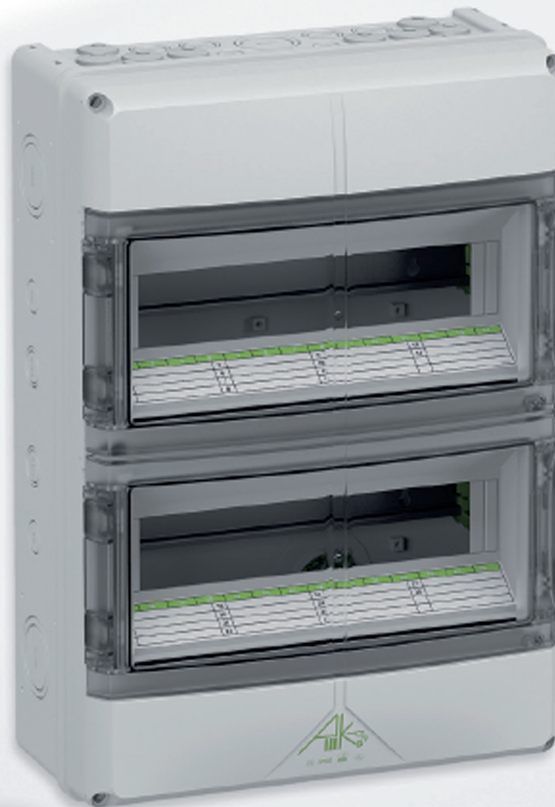

www.DLG-Test.de

EG – KONFORMITÄTSERKLÄRUNG

EC – Declaration of Conformity

UE – Déclaration de conformité



Günther Spelsberg GmbH + Co. KG
Elektro-Installationssysteme

Hersteller / Anschrift: Günther Spelsberg GmbH + Co. KG
Manufacturer / Address
Fabricant / Adresse Im Gewerbepark 1
58579 Schalksmühle
Bundesrepublik Deutschland

Produktbezeichnungen: **AK Kleinverteiler**
Product designation **AK Distribution board**
Désignation du produit **AK Coffret de distribution**

AK 14 / AK 14 Plus	733 414 01 / 733 614 01
AK-F 14 / AK-F 14 Plus	733 514 01 / 733 714 01
AK 28 / AK 28 Plus	733 428 01 / 733 628 01
AK-F 28 / AK-F 28 Plus	733 528 01 / 733 728 01
AK 42 / AK 42 Plus	733 442 01 / 733 642 01
AK-F 42 / AK-F 42 Plus	733 542 01 / 733 742 01
AK 56 / AK-F 56	733 456 01 / 733 556 01
AK 70	733 470 01

Nr. der Bescheinigung: 1104 / 04'15
No. of certificate/ N° du certificat

Das bezeichnete Produkt stimmt mit der Vorschrift folgender Europäischer Richtlinie überein.
The designated product corresponds to the regulations of the following European guideline.
Le produit désigné correspond à la prescription des directives européennes suivantes.

Niederspannungs-Richtlinie 2006/95/EG des Europäischen Parlaments und des Rates vom 12. Dezember 2006 zur Angleichung der Rechtsvorschriften der Mitgliedstaaten betreffend elektrische Betriebsmittel zur Verwendung innerhalb bestimmter Spannungsgrenzen

Directive 2006/95/EC of the European Parliament and of the Council of 12 December 2006 on the harmonisation of the laws of Member States relating to electrical equipment designed for use within certain voltage limits
Directive 2006/95/CE du Parlement européen et du Conseil du 12 décembre 2006 concernant le rapprochement des législations des États membres relatives au matériel électrique destiné à être employé dans certaines limites de tension

Angewandte Normen:
Applied standards / Normes applicables

Dosen und Gehäuse für Installationsgeräte für Haushalt und ähnliche ortsfeste elektrische Installationen
Boxes and enclosures for electrical accessories for household and similar fixed electrical installations
Boîtes et enveloppes pour appareillage électrique pour installations électriques fixes pour usages domestiques et analogues

DIN EN 60670-1:2014-01; EN 60670-1:2005+A1:2013
DIN EN 60670-24:2013-03; EN 60670-24:2013

Niederspannungs-Schaltgerätekombinationen
Low-voltage switchgear and controlgear assemblies
Ensembles d'appareillage de basse tension
DIN EN 61439-1:2012-06; EN 61439-1:2011
DIN EN 61439-2:2012-06; EN 61439-2:2011
DIN EN 61439-3:2013-02; EN 61439-3:2012

Diese Erklärung bescheinigt die Übereinstimmung mit den genannten Richtlinien, beinhaltet jedoch keine Zusicherung von Eigenschaften.

This certificate conformity with the named guidelines, but does not include any guarantee characteristics.
Cette déclaration certifie la conformité avec les directives dénommées, mais ne contient aucune garantie des caractéristiques.

Schalksmühle, den: 30.04.2015

Dipl.-Ing. Thorsten Verse

i.A. T. Verse

Name	Normungs- / Zertifizierungswesen	Unterschrift
<i>Name</i>	<i>Standardization / certification</i>	<i>Signature</i>
<i>Nom</i>	<i>Normalisation / certification</i>	<i>Signature</i>

Template for unit verification for low voltage switchgear combinations per EN 61439-3 with a rated voltage of $U_n = 230/400V$ and a rated current of max. 125A. Protection type of the enclosure unchanged IP65)

		Stücknachweis nach DIN EN 61439-3		
Hersteller: _____		Kunde: _____		
Straße: _____		Straße: _____		
PLZ/Ort: _____		PLZ/Ort: _____		
Auftrag / Pos.: _____				
Nr.	Prüfart	Prüfungen	ja	n.A.
11.5	V	Einbau von Betriebsmitteln Übereinstimmung mit den Schaltungsunterlagen und anderen Unterlagen, Kennzeichnung und Aufschriften, Vollständigkeit der Gebrauchs- und Serviceunterlagen	<input type="checkbox"/>	<input type="checkbox"/>
11.7	V	Anschlüsse für von außen eingeführte Leiter Anschluss, Typ und Kennzeichnung von Anschlüssen müssen mit den Fertigungsunterlagen übereinstimmen	<input type="checkbox"/>	<input type="checkbox"/>
11.8	M	Mechanische Funktion Mechanische Betätigungselemente, Verriegelungen und Verschlüsse überprüfen	<input type="checkbox"/>	<input type="checkbox"/>
11.3	S / E	Luft- und Kriechstrecken Luftstrecke durch Stoßspannungsprüfung mit 5,1kV ACeff (1,2/50µs) wenn Luftstrecken < 4,5mm, sonst elektr. Prüfung Kriechstrecke durch Sichtprüfung: 6,3mm	<input type="checkbox"/>	<input type="checkbox"/>
11.6	M	Innere Verbindungen Geschraubte Verbindungen stichprobenartig auf korrektes Drehmoment prüfen	<input type="checkbox"/>	<input type="checkbox"/>
	E	Innere elektrische Stromkreise Einwandfreie Verdrahtung in Übereinstimmung mit den Schaltungsunterlagen	<input type="checkbox"/>	<input type="checkbox"/>
11.4	S / E	Schutz gegen elektrischen Schlag und Durchgängigkeit der Schutz gegen direktes Berühren aktiver Teile, Durchgängigkeit des Schutzleiters (Widerstandsmessung mit min. 10A, max. 0,1 Ω)	<input type="checkbox"/>	<input type="checkbox"/>
11.10	S / E	Verdrahtung, Betriebsverhalten, Funktion Überprüfung Kennzeichnung, Verdrahtung elektrische Funktionsprüfung	<input type="checkbox"/>	<input type="checkbox"/>
11.9	E	Isolationseigenschaften Messung Isolationswiderstand mit 500V DC zwischen Stromkreisen und Körpern: $R > 400 \text{ k Ohm}$	<input type="checkbox"/>	<input type="checkbox"/>
11.2	S	Schutzart von Umhüllungen IP 65	<input type="checkbox"/>	<input type="checkbox"/>
	S	Verpackung	<input type="checkbox"/>	<input type="checkbox"/>
S= Sichtprüfung, M= mechanische Prüfung, E= elektrische Prüfung, V= Vergleich mit Fertigungsunterlagen				
n.A. =nicht abprüfbar				
Datum: _____		Prüfer: _____		



Visit us on Facebook!
www.facebook.com/spelsberg.de

Günther Spelsberg GmbH & Co. KG

Headquarters

Im Gewerbepark 1,
D-58579 Schalksmühle, Germany
Postfach 15 20, D-58571 Schalksmühle,
Germany

Phone: +49 2355 892-0

E-mail: info@spelsberg.de

Internet: www.spelsberg.de

Buttstädt factory

Vor dem Lohe 3,
D-99628 Buttstädt, Germany

Phone: +49 36373 98-400

VK23005

Subject to change due to
technical progress