

CYRA+ Refit LED-DOWNLIGHTS

CYRA+ XS, CYRA+ S, CYRA+ M, CYRA+ L, CYRA+ XL

MONTAGE- UND BETRIEBSANLEITUNG
INSTRUCTIONS FOR USE

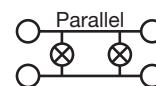

ELEKTROTECHNISCHE SICHERHEITSHINWEISE:

Beauftragen Sie mit der Installation eine Elektrofachkraft. Für Strahler, die nicht gemäß den europäischen Sicherheitsrichtlinien installiert wurden, entfällt jeder Haftungsanspruch.

Achtung!

CYRA+ Refit Sanierungsdownlight nur an einen geeigneten LED-Konverter anschließen. Für alle Anschlüsse sekundärseitig des Konverters ist ausschließlich flexible Niedervoltleitung zu verwenden.

MONTAGE- UND SICHERHEITSHINWEISE:

Stromschlaggefahr:

Vor der Installation oder Wechsel des Downlights die Spannung freischalten. Sicherstellen, dass die Spannung nicht versehentlich wieder eingeschaltet werden kann.

- Loch (sofern nicht bereits vorhanden) gemäß der Technischen Zeichnung anfertigen.
- Einbau in Betoneingießtöpfe möglich.

PRÜFZEICHEN UND SYMBOLE:

Betriebsgerät & CYRA+:



CE-konform mit den zutreffenden europäischen Richtlinien.



RoHS-Prüfzeichen für Produkte, die keine Schwermetalle beinhalten (2011/65/EU)



REACH-Prüfzeichen für Produkte, deren chemische Bestandteile bekannt, registriert und zugelassen sind. (1907/2006/EG)

Betriebsgerät:



Schutzklasse II: doppelt oder verstärkt isoliertes Gehäuse



LED-Leuchte oder Betriebsgerät nicht mit Wärmedämmenden Stoffen abdecken.

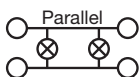

Parallelanschluss:
Für die Durchgangsverdrahtung geeignet.

Cyra+:



LED-Betriebsgerät durch Elektrofachkraft austauschbar.



LED-Modul durch Elektrofachkraft austauschbar.

TECHNISCHE DATEN:

LED-Konverter:

CC21W150-500 CC30W300-700	LC27MINI-DA150-700
Eingang: 200-240 VAC / 170-276 VDC 50, 60 /0Hz	Eingang: 200-240 VAC / 198-254 VDC 50, 60 /0Hz
Umgebungstemperatur: -20 bis +45° C	Umgebungstemperatur: -20 bis +45° C
P_{no}: ≤ 0,5 W	P_{no}: ≤ 0,5 W
Wirkungsgrad in Volllast: ≥ 87%	Wirkungsgrad in Volllast: ≥ 88%
Toleranz: ± 5%	Toleranz: ± 5%

CYRA+ Refit Downlights:

Leistungs- /Stromaufnahme:

7 W	9 W	14 W	18 W	24 W
200 mA	250 mA	400 mA	500 mA	700 mA

Farbwiedergabe:

CRI80 / CRI90 / CRI95

Blendungsbewertung:

UGR: <19

Ausstrahlwinkel:

60°

Einbautiefe:

85 mm

Lebensdauer:

L₇₀B₅₀: 60.000 h

L₈₀B₁₀: 50.000 h

Ökodesign:

Dieses Produkt enthält eine Lichtquelle der Energieeffizienzklasse D*.

* : Angabe für CRI80, 3000K

(abweichende Variante siehe Datenblatt auf www.rutec.de)

KONVERTER PRO LEITUNGSSCHUTZSCHALTER:

	B10	B16	B20	C10	C16	C20
CC21W 150-500	31 Stk	50 Stk	63 Stk	50 Stk	80 Stk	101 Stk
CC21W 350-700	31 Stk	50 Stk	63 Stk	50 Stk	80 Stk	101 Stk
LC27MINI-DA 150-700	38 Stk	60 Stk	76 Stk	38 Stk	60 Stk	76 Stk

TECHNISCHE ZEICHNUNGEN:

CYRA+ XS:

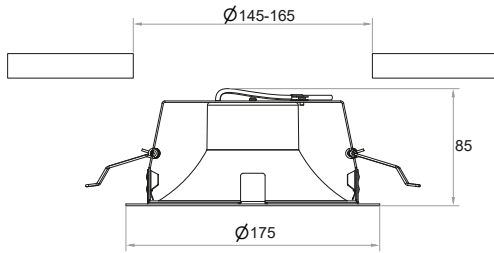

CYRA+ S:

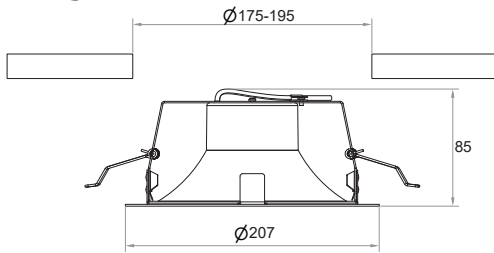

CYRA+ M:

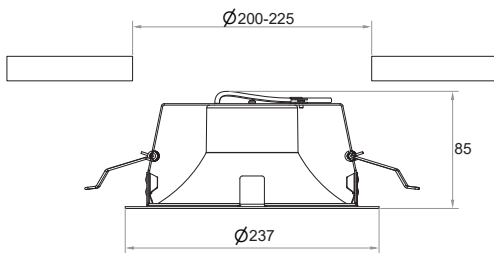

CYRA+ L:

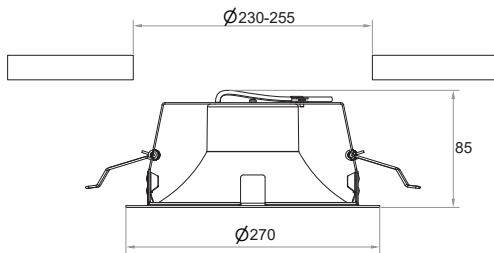

CYRA+ XL:

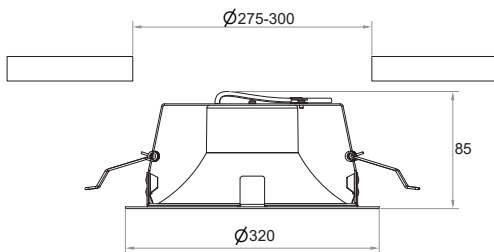

ANSCHLUSSSCHEMA:

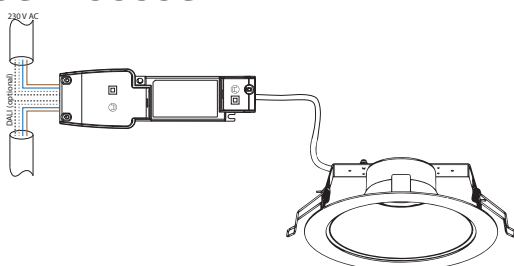

LED-Konverter: (CC21W150-500), (CC30W350-700)

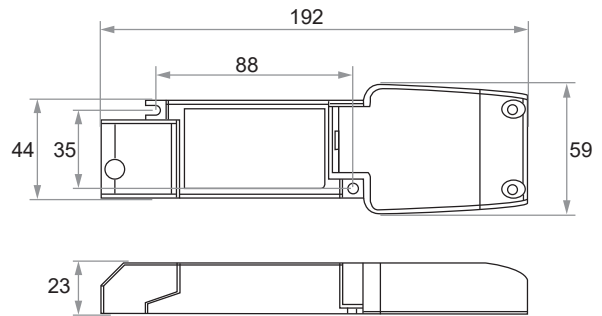

LED-Konverter: (LC27MINI-DA-150-700)

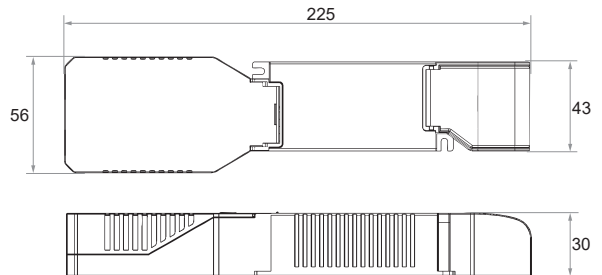

DIP-SWITCH EINSTELLUNG FÜR LEISTUNGS-AUSWAHL:

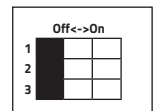

CC21W150-500:

Leistung Strom	Pin 1	Pin 2	Pin 3
7 W 200 mA	On	Off	Off
9 W 250 mA	Off	On	Off
14 W 400 mA	On	Off	On

CC30W350-700:

Leistung Strom	Pin 1	Pin 2	Pin 3
18 W 500 mA	On	On	Off
24 W 700 mA	On	On	On

(LC27MINI-DA-150-700):

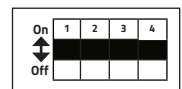

Leistung Strom	Pin 1	Pin 2	Pin 3	Pin 4
7 W 200 mA	On	Off	On	Off
9 W 250 mA	Off	On	On	Off
14 W 400 mA	On	Off	Off	On
18 W 500 mA	On	On	Off	On
24 W 700 mA	On	On	On	On

D

MONTAGEANLEITUNG:

1

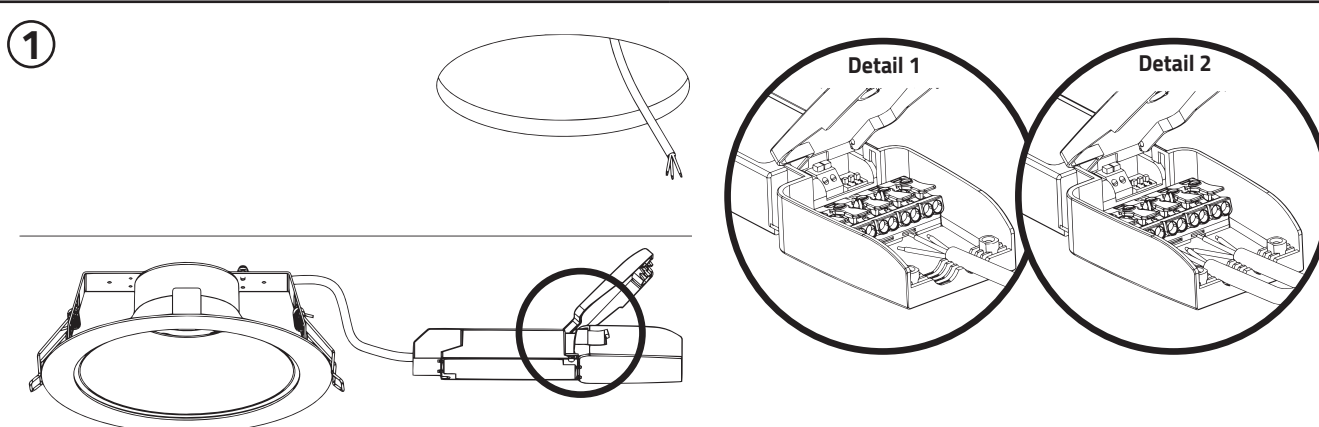

Nehmen Sie den Deckenausschnitt sofern nicht bereits vorhanden gemäß der technischen Zeichnung des entsprechenden CYRA Eco Models vor. Legen Sie die Leitung entsprechend Detail 1 bzw. 2 unter Beachtung der Polarität vor.

2

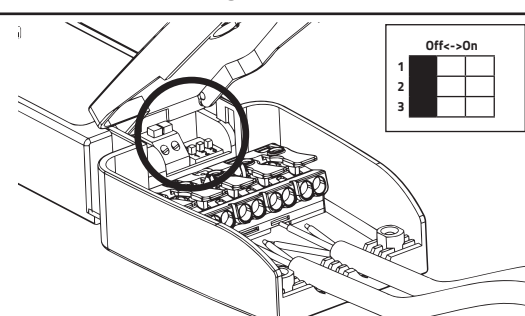

Off <-> On	
1	<input type="checkbox"/>
2	<input type="checkbox"/>
3	<input type="checkbox"/>

Stellen Sie die gewünschte Leistung des CYRA-Downlights gemäß der „DIP-SWITCH“ Tabelle mit Hilfe der 3 Dipschalter ein

3

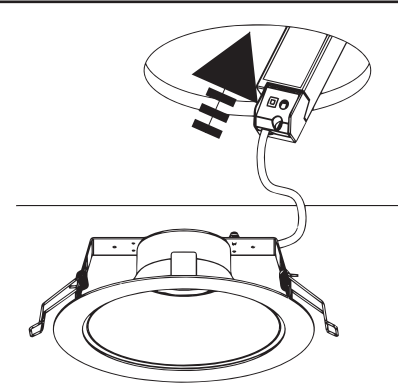

Führen Sie das LED-Betriebsgerät durch den Deckenausschnitt in den Installationsraum ein.

4

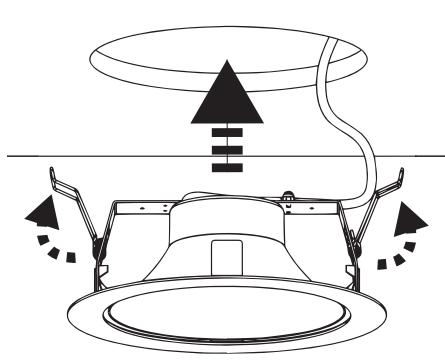

Führen Sie das LED-Downlight mit gespannten Federn in den Deckenausschnitt ein bis das Downlight mit den Anschlagswinkeln im Ausschnitt sitzt und an den Zentrierfedern anliegt. Drücken Sie das LED-Downlight im Anschluss mit leichten Druck in den Deckenausschnitt. Die abgekanteten Zentrierfedern positionieren das Downlight mittig im Deckenausschnitt.

5

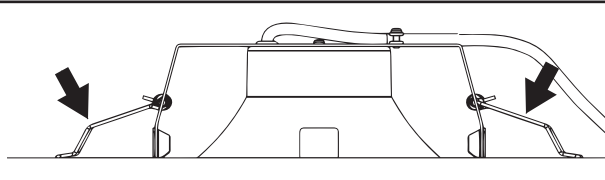

Die Spannfedern müssen nach der Installation in horizontaler Position liegen, nicht vertikaler. Bei korrekter Lage klappen Sie zurück und ziehen das LED-Downlight bündig an den Deckenausschnitt.

MODUL & LINSENWECHSEL:

Demontage:

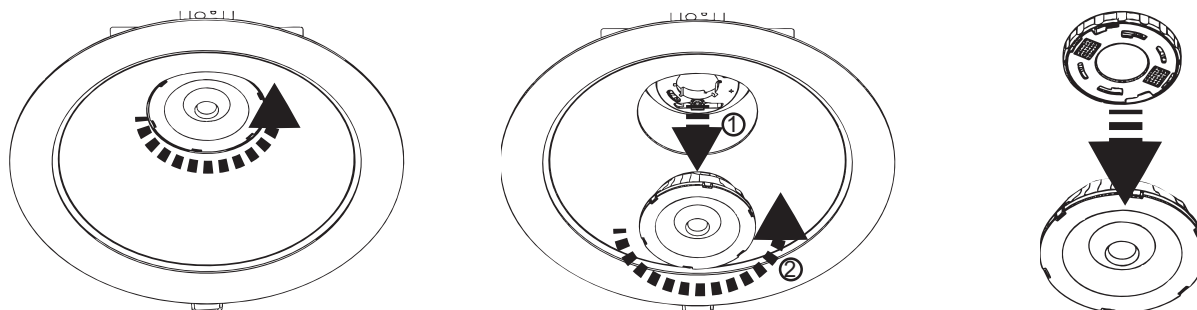

Um einen Linse oder Modulwechsel vorzunehmen, drehen sie die Linse/Modulkombination mit Hilfe einer 15° Drehung gegen den Uhrzeigersinn (nach links) und entnehmen sie diese aus dem Leuchtengehäuse. Jetzt können Sie die Linse mit einer weiteren 15° Drehung gegen den Uhrzeigersinn (nach links) vom Modul lösen und abnehmen.

Montage:

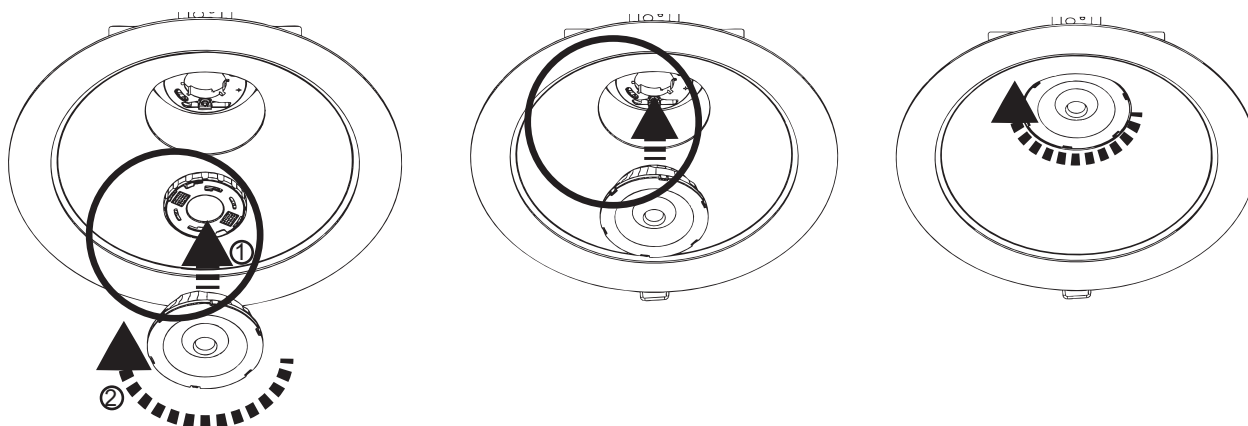

Um die Linse auf dem Modul anzubringen, führen Sie die beiden Nasen (Detail 3) der Linse in die außen liegenden Aufnahmen (Detail 4) des LED-Moduls und fixieren sie es mit Hilfe einer 15° Drehung im Uhrzeigersinn (nach rechts). Jetzt können Sie die Linse/Modulkombination gemäß (Detail 5) orientierend an der TC Kennzeichnung auf dem Modulsockel auf „1 Uhr“ und Minus Kennzeichnung auf Fassungssockel auf „11 Uhr“ (Detail 6) zusammen stecken und wiederum mit einer 15° Drehung im Uhrzeigersinn (nach rechts) fixieren.

Detail 3:

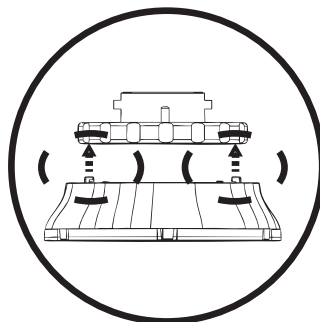

Detail 4:

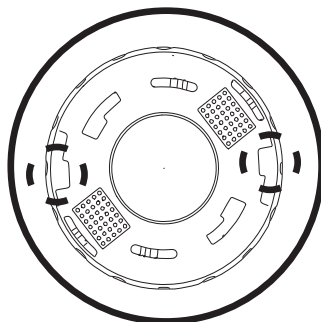

Detail 5:

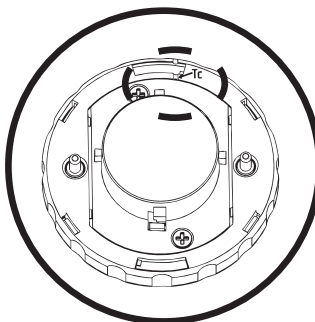

Detail 6:

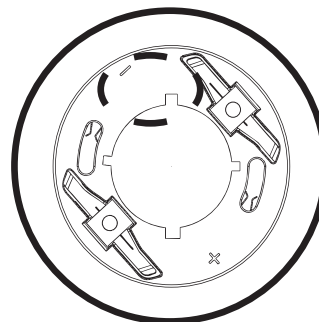

ELECTROTECHNICAL SAFETY INSTRUCTIONS:

Have the installation carried out by a qualified electrician. Any liability claim for spotlights that have not been installed in accordance with the European safety directives is void.

Attention!

Connect CYRA+ Refit LED-Downlights only to a suitable LED converter. Only use flexible low-voltage cable for all connections on the secondary side of the converter.

INSTALLATION & SAFETY INSTRUCTIONS:

Risk of electric shock:

Before installing or changing the downlight, disconnect the voltage. Ensure that the voltage cannot be switched on again accidentally.

- Make the hole (if not already present) according to the technical drawing.
- Can be installed in concrete pots.

MARKS AND SYMBOLS:

Control gear & CYRA+:



CE-compliant with the applicable European directives.



RoHS mark for products that do not contain heavy metals (2011/65/EU)



REACH mark for products whose chemical components are known, registered and authorised. (1907/2006/EC)

Operating device:



Protection class II: double or reinforced insulated housing.



Do not cover the LED luminaire or control gear with heat-insulating materials.

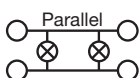

Parallel connection: Suitable for through-wiring.

CYRA+:



Replaceable control gear by a professional



Replaceable light source by a professional.

TECHNICAL DATA:

LED converter:

CC21W150-500 CC30W300-700	LC27MINI-DA150-700
Input: 200-240 VAC / 170-276 VDC 50, 60 /0Hz	Input: 200-240 VAC / 198-254 VDC 50, 60 /0Hz
Ambient temperature: -20 bis +45° C	Ambient temperature: -20 bis +45° C
P_{no}: ≤ 0,5 W	P_{no}: ≤ 0,5 W
Efficiency at full load: ≥ 87%	Efficiency at full load: ≥ 88%
Tolerance: ± 5%	Tolerance: ± 5%

CYRA Eco LED-Downlights:

Power- / current consumption:

7 W	9 W	14 W	18 W	24 W
200 mA	250 mA	400 mA	500 mA	700 mA

Colour rendering:

CRI80 / CRI90 / CRI95

Glare Rating:

UGR: <19

Beam angle:

60°

Installation depth:

85 mm

Lifetime:

L₇₀B₅₀: 60.000 h

L₈₀B₁₀: 50.000 h

Ecodesign:

This product contains a light source of energy efficiency class D*.

*: specification for CRI80, 3000K

(for a different version, see data sheet at www.rutec.de)

CONVERTER PER CIRCUIT BREAKER:

	B10	B16	B20	C10	C16	C20
CC21W 150-500	29 pcs	46 pcs	57 pcs	46 pcs	73 pcs	91 pcs
CC21W 350-700	29 pcs	46 pcs	57 pcs	46 pcs	73 pcs	91 pcs
LC27MINI-DA 150-700	38 pcs	60 pcs	76 pcs	38 pcs	60 pcs	76 pcs

TECHNICAL DRAWING:

CYRA+ XS:

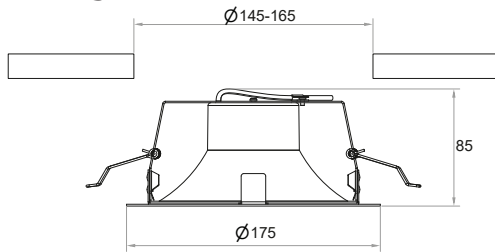

CYRA+ S:

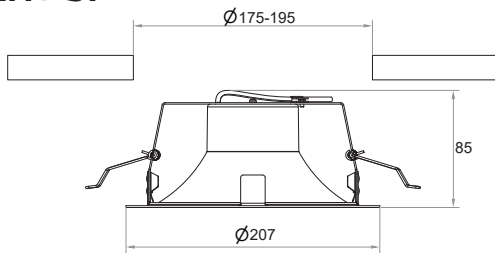

CYRA+ M:

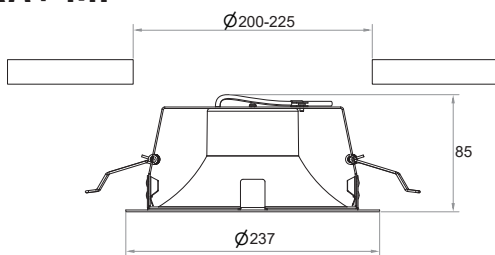

CYRA+ L:

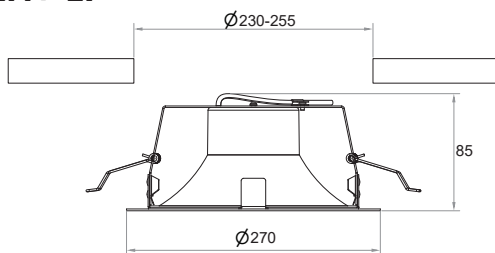

CYRA+ XL:

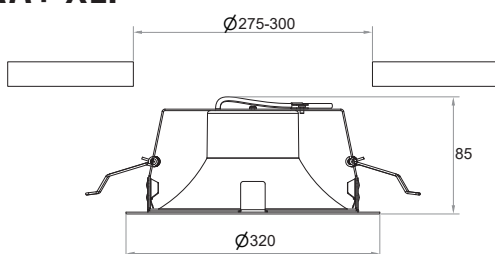

WIRING DIAGRAM:

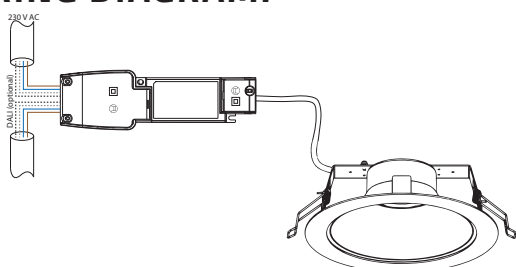

LED-Converter: (CC21W150-500), (CC30W350-700)

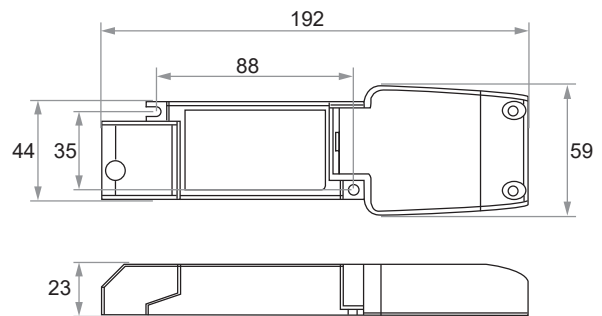

LED-Converter: (LC27MINI-DA-150-700)

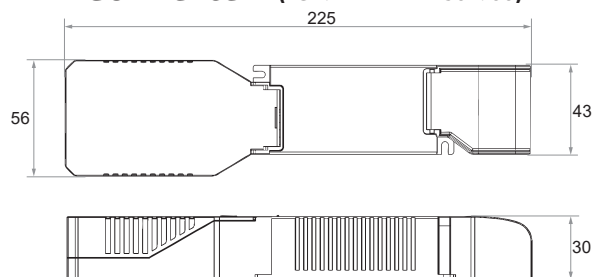

DIP-SWITCH SELECTION FOR POWER SETTING:

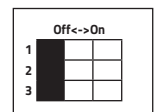

CC21W150-500:

Power Current	Pin 1	Pin 2	Pin 3
7 W 200 mA	On	Off	Off
9 W 250 mA	Off	On	Off
14 W 400 mA	On	Off	On

CC30W350-700:

Power Current	Pin 1	Pin 2	Pin 3
18 W 500 mA	On	On	Off
24 W 700 mA	On	On	On

(LC27MINI-DA-150-700):

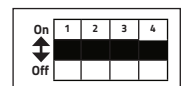

Power Current	Pin 1	Pin 2	Pin 3	Pin 4
7 W 200 mA	On	Off	On	Off
9 W 250 mA	Off	On	On	Off
14 W 400 mA	On	Off	Off	On
18 W 500 mA	On	On	Off	On
24 W 700 mA	On	On	On	On

MOUNTING INSTRUCTION:

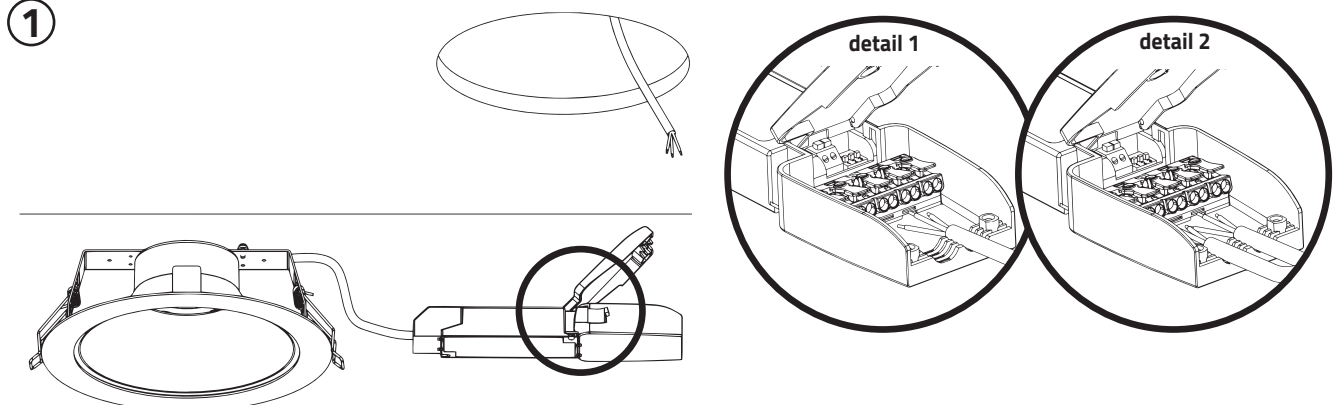
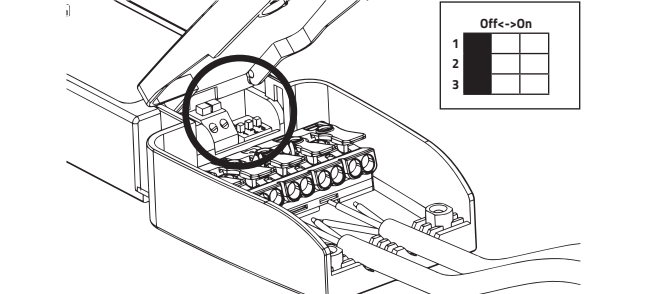
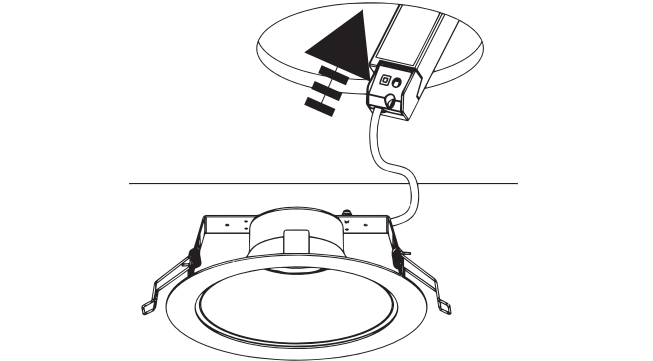
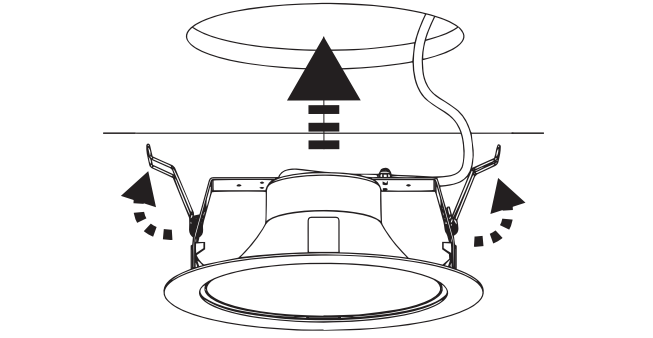
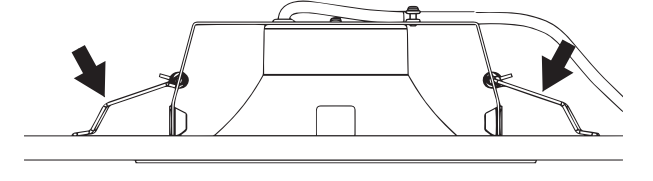
<p>①</p> 	<p>If not already present, cut out the ceiling according to the technical drawing of the corresponding CYRA Eco model. Lay the cable according to detail 1 or 2, observing the polarity.</p>								
<p>②</p> <p>Set the desired power of the CYRA Eco LED-downlight according to the „DIP-SWITCH“ table using the 3 dip switches</p>	 <table border="1" data-bbox="1244 828 1388 929"> <thead> <tr> <th colspan="2">Off->On</th> </tr> </thead> <tbody> <tr> <td>1</td> <td><input type="checkbox"/></td> </tr> <tr> <td>2</td> <td><input type="checkbox"/></td> </tr> <tr> <td>3</td> <td><input type="checkbox"/></td> </tr> </tbody> </table>	Off->On		1	<input type="checkbox"/>	2	<input type="checkbox"/>	3	<input type="checkbox"/>
Off->On									
1	<input type="checkbox"/>								
2	<input type="checkbox"/>								
3	<input type="checkbox"/>								
<p>③</p> <p>Insert the LED control gear through the ceiling cut-out into the installation room.</p>									
<p>④</p> <p>Insert the CYRA Eco LED-downlight with tensioned springs into the ceiling cut-out until the downlight is seated with the stop angles in the cut-out and rests against the centring springs. Then press the LED downlight lightly into the ceiling cut-out. The bevelled centring springs position the downlight centrally in the ceiling cut-out.</p>									
<p>⑤</p> <p>The tension springs must be in a horizontal position after installation, not vertical. If the downlight is correct position, the springs fold back and the CYRA Eco LED-downlight pulls itself against the ceiling cut-out.</p>									

MODULE & LENS CHANGE:

Disassembly:

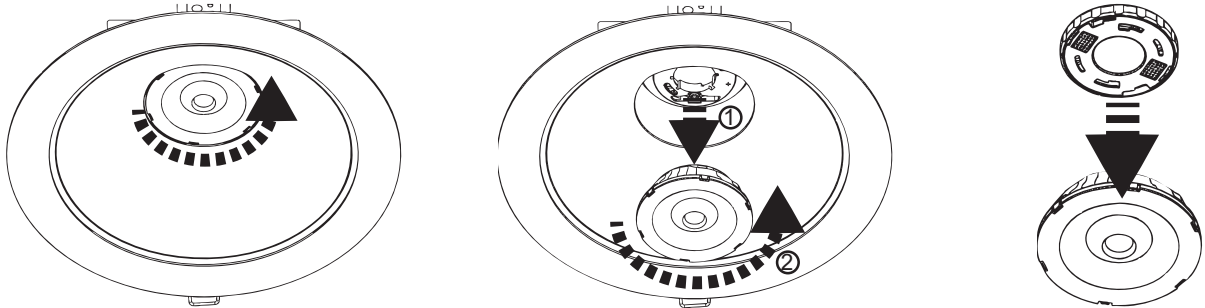

To change the lens or module, turn the lens module combination anti-clockwise (to the left) by 15° and remove it from the luminaire housing. Now you can loosen and remove the lens from the module by turning it a further 15° anti-clockwise (to the left).

Assembly:

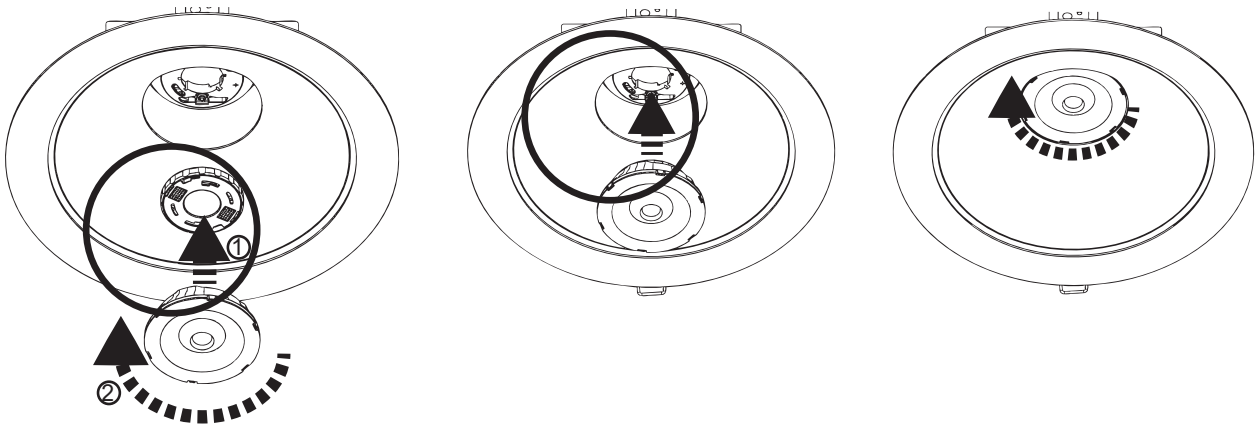

To attach the lens to the module, guide the two lugs (detail 3) of the lens into the external receptacles (detail 4) of the LED module and fix it in place by turning it 15° clockwise (to the right). Now you can plug the lens module combination together in accordance with (detail 5), orientating it to the TC marking on the module base at '1 o'clock' and the minus marking on the socket base at '11 o'clock' (detail 6) and fix it in place again by turning it 15° clockwise (to the right).

detail 3:

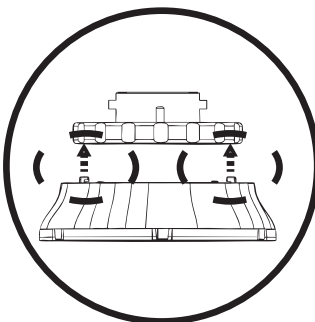

detail 4:

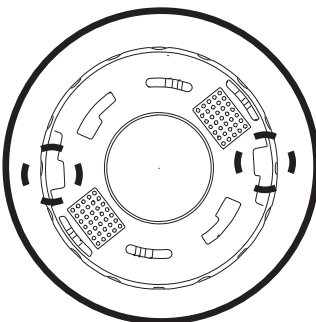

detail 5:

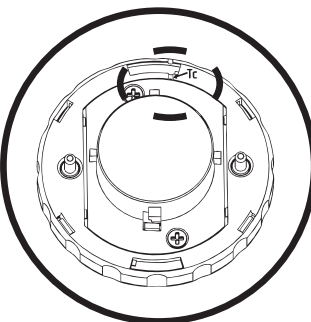

detail 6:

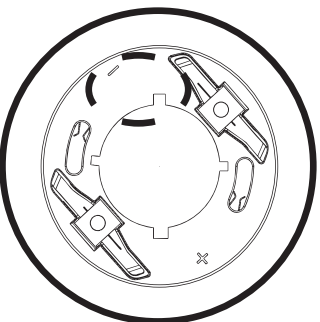



ENTSORGUNG:



Entsorgen Sie elektrische und elektronische Geräte umweltgerecht. Nähere Informationen erhalten Sie bei Ihrer zuständigen Behörde.



DISPOSAL:



Dispose of electrical and electronic equipment in an environmentally sound manner. For more information, contact your local authority.

