



www.klauke.com

ES 32ISM ES 32SISM



Serialnumber

HE.18604_E © 04/2019 R&D-2

MET/Eurofins
approved design
Report # 105276







UK
CA Klauke UK Ltd.
NR35 1JX

Gustav Klauke GmbH • Auf dem Knapp 46 • D-42855 Remscheid • Telefon +49 2191 907 0 • www.klauke.com

Klauke®



	Page
Before work	I - II
Bestimmungsgemäße Verwendung / Intended use	
Fehlanwendung / Misuse	III - VI
SERVICE 	VII - IX
 Techn. Data	X - XIII
WORK 	XIV - XV
 CE DoC	XVI - XVIII
 ASC	ASC 1 - ASC 4



Wir freuen uns, dass Sie sich für ein Klauke Werkzeug entschieden haben und wünschen Ihnen viel Freude damit.



Sie haben ein Qualitätsprodukt „Made in Germany“ erworben und erhalten 2 Jahre Garantie. Diese beginnt mit dem Kaufbelegdatum.

Zur Aufrechterhaltung der ordnungsgemäßen elektrischen Isoliereigenschaften muss das Produkt nach 5.000 Betätigungen oder 2 Jahren oder früher, wenn die Isolationsbarriere beschädigt ist oder Öl aus dem Werkzeug austritt, von Klauke oder seinem autorisierten Service-Center (ASC) gewartet werden. Sollte das Serviceintervall 5.000 Betätigungen oder 2 Jahre überschreiten, erlischt die Produktgarantie.

Im Rahmen dieser Wartung werden verschlissene Teile ersetzt und sicherheitsrelevante Teile geprüft und ggf. vorbeugend ersetzt.

Bediener müssen zum Arbeiten an Niederspannungsanlagen autorisiert und trainiert worden sein. Alle Werkzeuge müssen in Übereinstimmung mit örtlichen Sicherheitsregeln für das Arbeiten unter Spannung betrieben werden.

Für Fragen rund um unseren Werkzeugservice oder eine Frage zu einem bestimmten Anwendungsfall stehen wir Ihnen persönlich unter der kostenlosen Hotline 0800-4685528 zur Verfügung.



Ihr Klauke Team

Thank you for choosing a Klauke tool. We hope it gives you lots of pleasure.



You have purchased a quality product „Made in Germany“, which is covered by a 2 year warranty. The warranty commences from the purchase receipt date.

To maintain proper electrical insulating properties, the product must be serviced by Klauke or its Authorized Service Center (ASC) after 5,000 operations or 2 years, or earlier if the insulation barrier is damaged or oil leaks from the tool. Should the service interval exceed 5,000 operations, or 2 years the product warranty will become void.

The Service includes predictive maintenance in which worn-out parts will be replaced and safety relevant parts checked/replaced.

All users must be authorized and trained for LV working. All tools must be used in accordance with local Live Line procedures.

If you have any questions about our tool service or about a specific application, please go to <http://www.klauke.com/en/service/tool-service/>



Your Klauke team



Persönliche Schutzausrüstung Personal Protective Equipment

PSA
PPE

BEFORE WORK

Verwenden Sie PSA in Übereinstimmung mit örtlichen Arbeitsanweisungen!

Use PPE in line with local operating live working procedures!

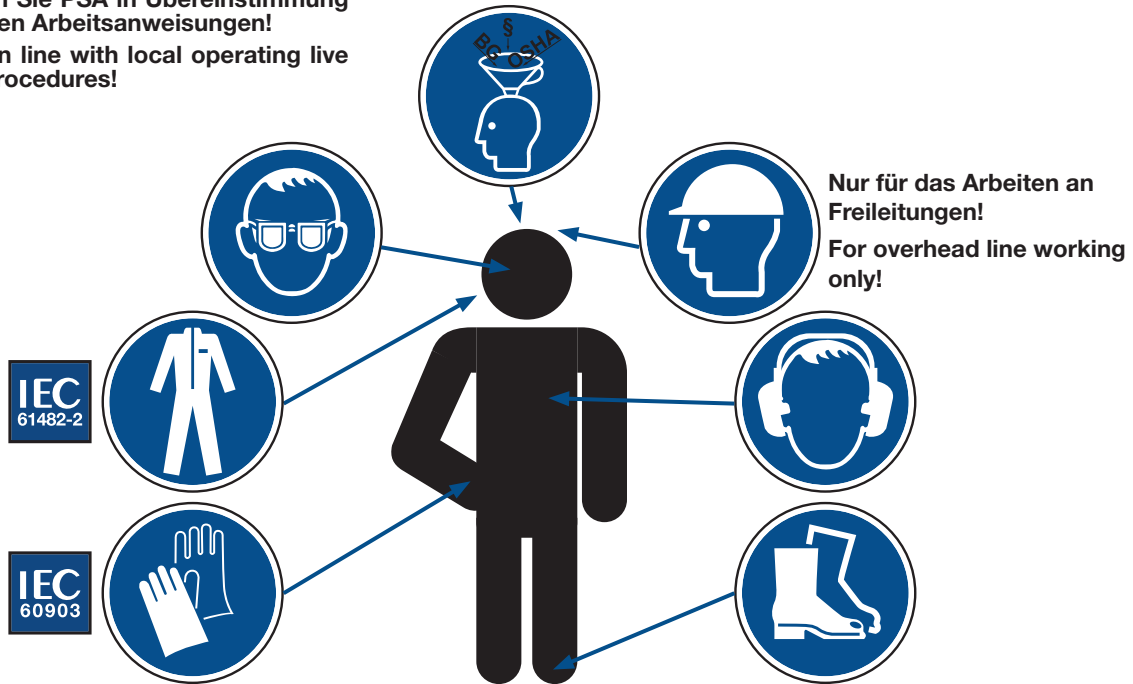



BEFORE WORK



Abb. ähnlich / pic. similar
HE.18604_E © 04/2019





! WARNING

Read all safety warnings, instructions, illustrations and specifications provided with this power tool.
Failure to follow all instructions listed below may result in electric shock, fire and/or serious injury.
Save all warnings and instructions for future reference.



Bestimmungsgemäße Verwendung
Intended use ✓

Eindrähtiger Rundleiter cable CL1 - re	Freileitung (Aldrey) conductor CL2 - rm	Mehrdrähtiger Rundleiter cable CL2 - rm	Verdichtet Mehrdrähtig cable CL2 - rm/V compacted

! Fehlanwendung
Misuse

Feindrähtig cable CL5 - F	Feinstdrähtig cable CL6 - F	ACSR	Armierter Leiter reinforced conductor



Bestimmungsgemäße Verwendung
Intended use ✓



Einleiterkabel
Single core

! Fehlanwendung
Misuse

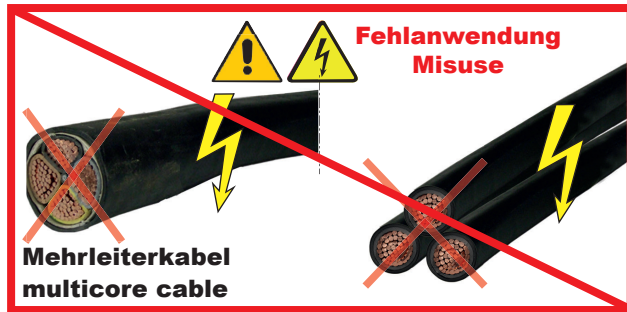

Mehrleiterkabel
multicore cable





Bestimmungsgemäße Verwendung

Intended use ✓



IEC 60900

1000V



Fehlanwendung
Misuse



Abb. ähnlich / pic. similar
HE.18604_E © 04/2019





 **WARNING**

Verwenden Sie Werkzeuge ausschließlich in Übereinstimmung mit firmeneigenen Arbeitsanweisungen.

Use tool always in accordance with company procedures.

 **WARNING**

Werkzeugführer müssen von der Firma für die zu verrichtende Arbeit autorisiert sein.

Users must be authorized for the work they do by the company.

 **WARNING**

Allgemeine Regel: Behandeln Sie alle Kabel als wären Sie unter Spannung.

General rule: Always treat all cable as being live.

 **WARNING**

Kein ATEX Werkzeug

No ATEX tool

 **WARNING**

Überprüfen Sie die Kabelspezifikationen, um zu bestätigen, dass das Kabel nicht mehrdrig ist. Das Schneiden von stromführenden mehradrigen Kabeln oder mehrerer stromführender Kabel gleichzeitig kann zu einem Lichtbogenüberschlag oder einem Stromschlag mit Todesfolge führen. Verwenden Sie dieses Werkzeug nicht zum Schneiden mehrdrig oder mehrerer Kabel.

Check cable specifications to confirm that the cable is not multi-phase. Cutting live multi-phase cables, or multiple live cables at the same time, can result in arc flash or electrocution and death. Do not use this tool to cut multi-phase or multiple cables.





! WARNING

Schneiden Sie keine unter Spannung stehenden mehradrigen Kabel. Prüfen Sie vor Arbeitsbeginn die mehradrigen Kabel auf Spannungsfreiheit.

Do not cut live multicore cables. Always check for multicore cables before starting work.

BEFORE WORK

DIN EN 50110

max. Armlänge
max. arm length





ES 32ISM, ES 32SISM

Klauke

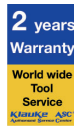



1			
2			
		ERROR CODE: ****	Error code *1
3a		BT P 3 bar P 3 bar	Bluetooth (if connected) Battery charging level Current pressure Pressure max. *2
3b	 3 sec.	bar / psi	to change: bar / psi
3c		bar / psi	
3b	 3 sec.	kN / lbf	to change: kN / lbf
3d		BT F 74 lbf F 369 lbf	
4a		USER 3: RD3 Doppelklick	Doubleclick
4b	 3 sec.	USER SELECT: RD3 Einfachklick	Singleclick enter menu
4c		USER SELECT: RD3 Doppelklick	Doubleclick select
4d		USER SELECT: RD3 Doppelklick	Doubleclick confirmed
5		NEXT SERVICE: 9826 0Ps	Cycles (until next service)
6		TOTAL: t = 0.07 h Q = 21.12 Ah n = 174	Since manufacturing: operating hours Capacity # crimps
7			

- *1 Error codes:
- 1 Overcurrent fuse
 - 2 Overcurrent comparator
 - 3 Overheat board
 - 4 Overheat battery
 - 5 Battery empty, operation stop
 - 6 Faulty crimp motor in operation
 - 7 Faulty crimp motor not in operation
 - 8 Low battery
 - 9 Battery empty
 - 10 RTC battery low
 - 11 Tool deactivated
 - 12 Service necessary
 - 13 RTC not found
 - 14 BT unit not found
 - 16 Pressure sensor not found
 - 17 Burst pressure exceeded
 - 18 Battery temperature too low

- 1 Überstrom durch Überstromsicherung
- 2 Überstrom durch Komparator
- 3 Boardtemperatur zu hoch
- 4 Akkutemperatur zu hoch
- 5 Akkuspannung während der Operation zu gering
- 6 Fehlpressung bei laufendem Motor
- 7 Fehlpressung bei stehendem Motor
- 8 Niedrige Akkuspannung
- 9 Akku leer
- 10 RTC-Batterie leer
- 11 Werkzeug deaktiviert
- 12 Service nötig
- 13 RTC nicht verfügbar
- 14 BT-Modul nicht verfügbar
- 16 Drucksensor nicht verfügbar
- 17 Berstdruck überschritten
- 18 Akkutemperatur zu gering

*2 (2Hz)





	DISPLAY	Wann/When/Quand/Quando/ cuándo/Wanneer/Когда/это происходит/Kiedy/quando	Warum/Why/Pourquoi/Porquê/ ¿por qué?/Waarom/Причина/ Dlaczego/Perché
 20 sec		nach Arbeitsvorgang after working cycle après opération de travail Después del proceso de trabajo após o processo de trabalho na bedrijfscyclus после цикла опрессовки po zakończeniu pracy dopo il processo di lavoro	
 20 sec/2Hz 40 x		day 640 - 730 or operations 4751 - 5000	Klauke ASC Authorised Service Center
 20 sec/2Hz 40 x		day 731 ... or operations 5001 ...	 only 1 x operation <hr/> only 1 x operation ∞
 20 sec/5Hz		während der Übertemperatur while exceeding the temp. limit pendant surchauffe en caso de temperatura excesiva durante a temperatura excessiva tijdens te hoge temperatuur при высокой температуре внутри корпуса przy przegrzaniu superando il limite di temperatura	Werkzeug zu heiß Unit too hot outil surchauffé Herramienta demasiado caliente ferramenta demasiado quente gereedschap te heet Перегрев инструмента urządzenie za gorące Utensile troppo caldo

D GB F E P NL RUS PL I





ES 32ISM, ES 32SISM

Klauke

ES 32ISM

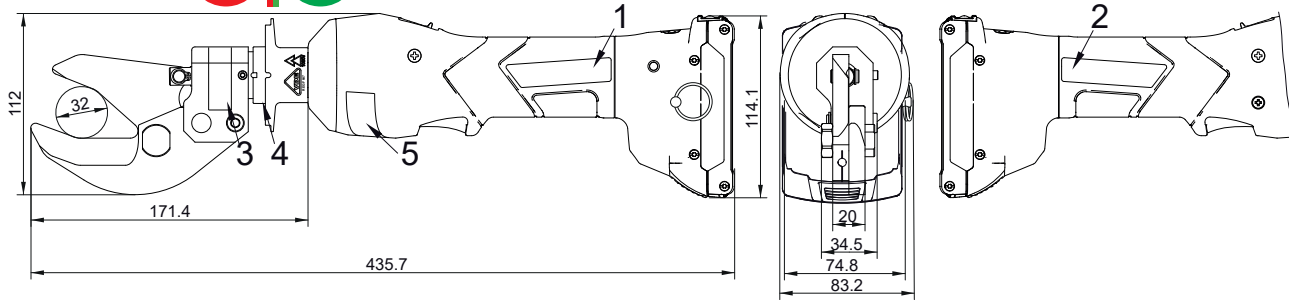

5

⚠️ AVERTISSEMENT	⚠️ WARNING	⚠️ ADVERTENCIA
Inspecter l'outil avant chaque utilisation. Ne pas utiliser si des dégâts ou de l'huile hydraulique sont observés. Les dégâts peuvent compromettre l'isolation de l'outil.	Inspect tool before each use. Do not use if damage or hydraulic oil is observed. Damage may compromise insulation.	Inspeccione la herramienta antes de usar. Si la herramienta está dañada o se ha tirado aceite hidráulico, no la use. El daño puede comprometer el aislamiento.

53087034 RE32



Abb. ähnlich / pic. similar
HE.18604_E © 04/2019





ES 32ISM, ES 32SISM

Klauke

ES 32SISM

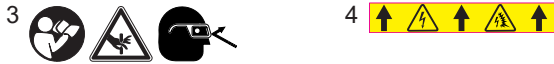
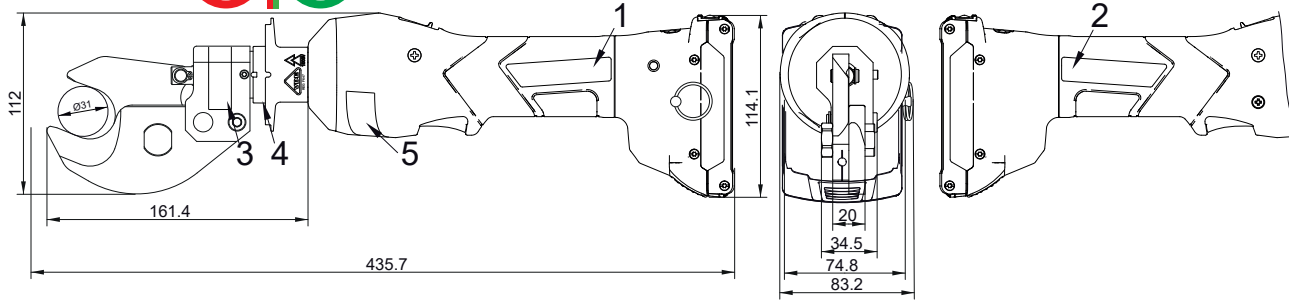

5

⚠️ AVERTISSEMENT	⚠️ WARNING	⚠️ ADVERTENCIA
Inspecter l'outil avant chaque utilisation. Ne pas utiliser si des dégâts ou de l'huile hydraulique sont observés. Les dégâts peuvent compromettre l'isolation de l'outil.	Inspect tool before each use. Do not use if damage or hydraulic oil is observed. Damage may compromise insulation.	Inspeccione la herramienta antes de usar. Si la herramienta está dañada o se ha tirado aceite hidráulico, no la use. El daño puede comprometer el aislamiento.

53087034 RE32

 +40°C -10°C	 BIO	 VIBR <2,5m/s ²	 <70dB
 2,2 kg	 19 kN		

Abb. ähnlich / pic. similar
HE.18604_E © 04/2019

WORK ✓	SERVICE	DON'T DO	General safety rules HE.16048
---------------	----------------	-----------------	---



ES 32ISM, ES 32SISM

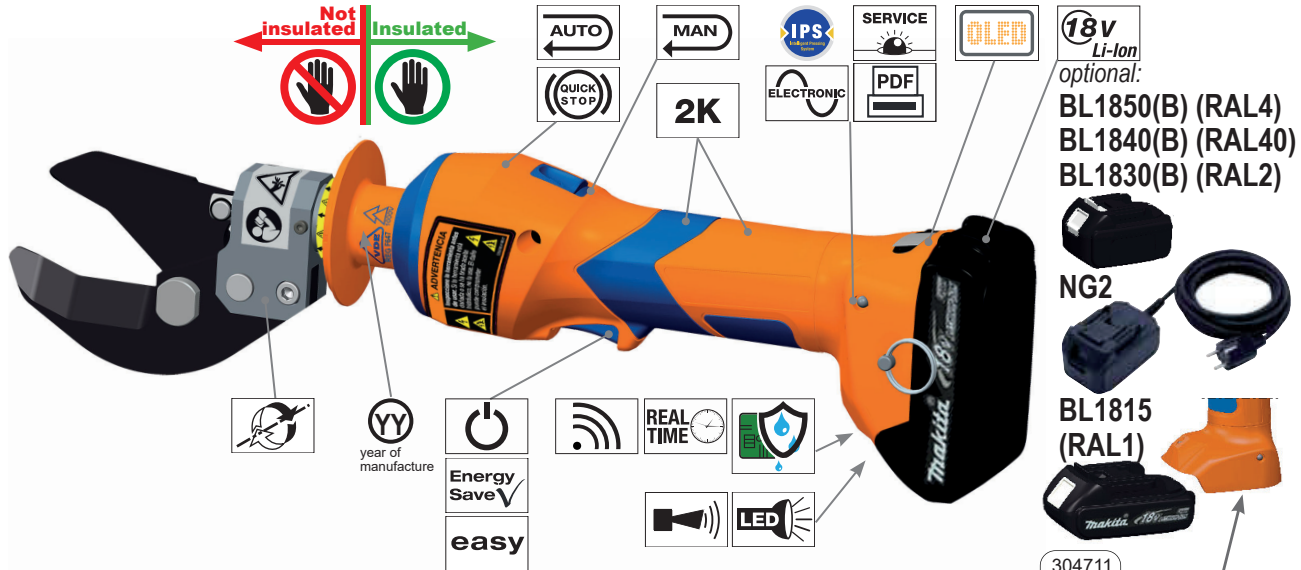

For US and Canada only
FCC ID: RFRMS42 • IC: 4957A-MS42
Model: CFM
 This device complies with Part 15 of the FCC Rules and with Industry Canada licence-exempt RSS standard(s). Operation is subject to the following two conditions: (1) this device may not cause harmful interference, and (2) this device must accept any interference received, including interference that may cause undesired operation.
HE.18065_D

datecode

Year	Code	Month	Code	Month	Code
2022	R	Jan.	N	July	V
2023	S	Feb.	P	Aug.	W
2024	T	Mar.	Q	Sept.	X
2025	V	Apr.	R	Oct.	Y
2026	W	May	S	Nov.	Z
2027	X	June	T	Dec.	1

batch# e.g. 304711
 datecode e.g. X = 2027; N = Jan.
 consecutive# e.g. „142“ = tool # 142



Abb. ähnlich / pic. similar
 HE.18604_E © 04/2019





ES 32ISM, ES 32SISM

Use tool only with 18 V Makita battery



BL1850(B) 45 min.

RAL4

BL1840(B) 36 min.

RAL40

BL1830(B) 22 min.

RAL2

BL1815 15 min.

RAL1



10 - 40°C



Alle Bedienungsanleitungen auch unter www.klauke.de abrufbar
All manuals are also available on www.klauke.com

Abb. ähnlich / pic. similar
HE.18604_E © 04/2019





ES 32ISM, ES 32SISM

Klauke



Abb. ähnlich / pic. similar
HE.18604_E © 04/2019



General safety rules
HE.16048

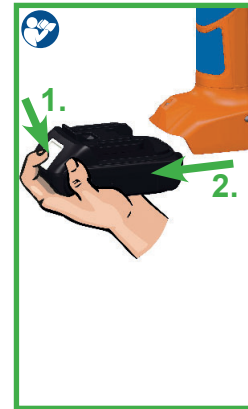

ES 32ISM, ES 32SISM

Klauke



Abb. ähnlich / pic. similar
HE.18604_E © 04/2019



Handgeführtes batteriebetriebenes Elektrowerkzeug Typ ES 32ISM, ES 32SISM

Klauke

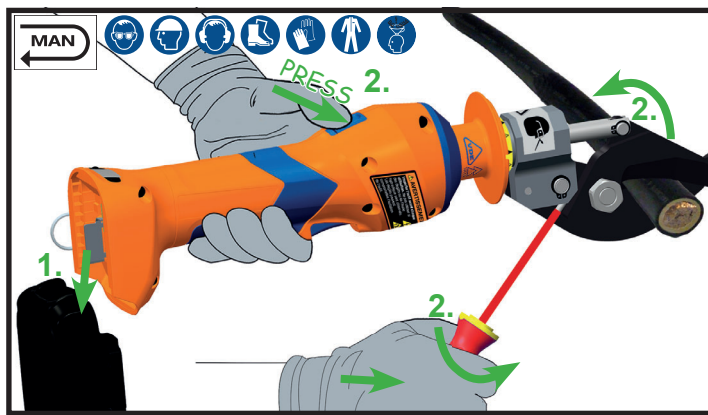
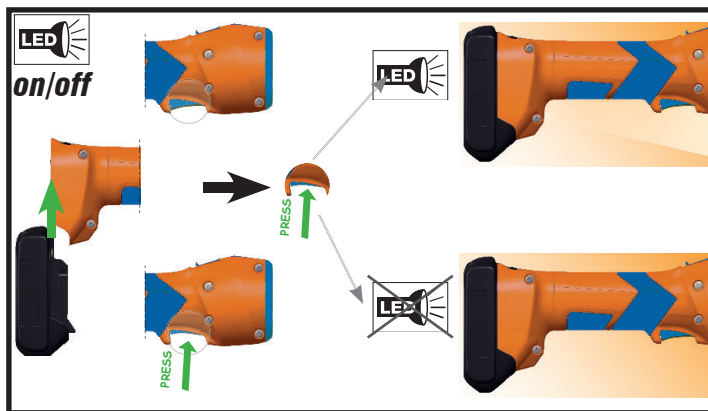
(D) CE-19 - Konformitätserklärung. Wir erklären in alleiniger Verantwortlichkeit, daß dieses Produkt mit den folgenden Normen oder normativen Dokumenten übereinstimmt: EN 62841-1, EN ISO 12100, EN ISO 13857, EN ISO 13854, EN 28662-1, EN 61000-6-3, EN 61000-6-2, EN 60529, EN 1037 gemäß den Bestimmungen der Richtlinien 2006/42/EG, 2014/30/EU, 2011/65/EU

(GB) CE-19 - Declaration of conformity. We declare under our sole responsibility that this product is in conformity with the following standards or normative documents: EN 62841-1, EN ISO 12100, EN ISO 13857, EN ISO 13854, EN 28662-1, EN 61000-6-3, EN 61000-6-2, EN 60529, EN 1037 in accordance with the regulations of directives 2006/42/EG, 2014/30/EU, 2011/65/EU

(F) CE-19 - Déclaration de conformité. Nous déclarons sous notre seule responsabilité que ce produit est en conformité avec les normes ou documents normatifs suivants: EN 62841-1, EN ISO 12100, EN ISO 13857, EN ISO 13854, EN 28662-1, EN 61000-6-3, EN 61000-6-2, EN 60529, EN 1037 conformément aux réglementations des directives 2006/42/EG, 2014/30/EU, 2011/65/EU

(E) CE-19 - Declaración de conformidad. Declaramos bajo nuestra sola responsabilidad que este producto está en conformidad con las normas o documentos normativos siguientes: EN 62841-1, EN ISO 12100, EN ISO 13857, EN ISO 13854, EN 28662-1, EN 61000-6-3, EN 61000-6-2, EN 60529, EN 1037 de acuerdo con las regulaciones de las directivas 2006/42/EG, 2014/30/EU, 2011/65/EU

(I) CE-19 - Dichiarazione di conformità. Dichiariamo sotto la nostra esclusiva responsabilità che questo prodotto è conforme alle seguenti norme e documenti normativi: EN 62841-1, EN ISO 12100, EN ISO 13857, EN ISO 13854, EN 28662-1, EN 61000-6-3, EN 61000-6-2, EN 60529, EN 1037 conformemente alle disposizioni delle direttive 2006/42/EG, 2014/30/EU, 2011/65/EU

(P) CE-19 - Declaração de conformidade. Declaramos sob nossa exclusiva responsabilidade que este produto cumpre as seguintes normas ou documentos normativos: EN 62841-1, EN ISO 12100, EN ISO 13857, EN ISO 13854, EN 28662-1, EN 61000-6-3, EN 61000-6-2, EN 60529, EN 1037 conforme as disposições das directivas 2006/42/EG, 2014/30/EU, 2011/65/EU

(NL) CE-19 - Konformiteitsverklaring. Wij verklaren en wij stellen ons er alleen voor verantwoordelijk dat dit product voldoet aan de volgende normen of normatieve documenten: EN 62841-1, EN ISO 12100, EN ISO 13857, EN ISO 13854, EN 28662-1, EN 61000-6-3, EN 61000-6-2, EN 60529, EN 1037 overeenkomstig de bepalingen van de richtlijnen 2006/42/EG, 2014/30/EU, 2011/65/EU

(GR) CE-19 - ΔΗΛΩΣΗ ΣΥΜΜΟΡΦΩΣΗΣ Με αναληψη συλλογικης δηλωνομε: οτι το πορον προιον συμφωρει με τα παρακατω ποστυπα και με τα ηρωτηα ηου αναφερονται στα σχετικα εγγραφα EN 62841-1, EN ISO 12100, EN ISO 13857, EN ISO 13854, EN 28662-1, EN 61000-6-3, EN 61000-6-2, EN 60529, EN 1037 συμφωνα με τοχς κοινοισμους 2006/42/EG, 2014/30/EU, 2011/65/EU

(S) CE-19 - Konformitetsdeklaration. Vi förklarar på eget ansvar att denna produkt överensstämmer med följande normer eller normativa dokument: EN 62841-1, EN ISO 12100, EN ISO 13857, EN ISO 13854, EN 28662-1, EN 61000-6-3, EN 61000-6-2, EN 60529, EN 1037 enligt bestämmelserna i direktiverna 2006/42/EG, 2014/30/EU, 2011/65/EU

(DK) CE-19 - Konformitetserklæring. Vi erklærer under almindeligt ansvar at dette produkt er i overensstemmelse med følgende normer eller normative dokumenter: EN 62841-1, EN ISO 12100, EN ISO 13857, EN ISO 13854, EN 28662-1, EN 61000-6-3, EN 61000-6-2, EN 60529, EN 1037 i henhold til bestemmelserne i direktiverne 2006/42/EØF, 2014/30/EU, 2011/65/EU

(N) CE-19 - Konformitetserklæring. Vi erklærer på eget ansvarighet at dette produkt er i overensstemmelse med følgende standarder eller standard-dokumenter: EN 62841-1, EN ISO 12100, EN ISO 13857, EN ISO 13854, EN 28662-1, EN 61000-6-3, EN 61000-6-2, EN 60529, EN 1037 i henhold til bestemmelserne i direktive ne 2006/42/EØF, 2014/30/EU, 2011/65/EU

(FIN) CE-19 - Todistus standardinmukaissuudesta. Asiaa vastaavana todistamme täten, että tämä tuote on seuraavien standardien ja standardoimisasiakirjojen vaatimusten mukainen: EN 62841-1, EN ISO 12100, EN ISO 13857, EN ISO 13854, EN 28662-1, EN 61000-6-3, EN 61000-6-2, EN 60529, EN 1037 ja vastaa säädöksiä 2006/42/EG, 2014/30/EU, 2011/65/EU

(SK) CE-19 - Prehlásenie o zhode. Prehlasujeme na vlastnú zodpovednosť, že tieto produkty sú v súlade s nasledovnými normami: EN 62841-1, EN ISO 12100, EN ISO 13857, EN ISO 13854, EN 28662-1, EN 61000-6-3, EN 61000-6-2, EN 60529, EN 1037 a v zhode so smernicami 2006/42/EG, 2014/30/EU, 2011/65/EU

(PL) CE-19 - Zgodność z dyrektywami CE. Świadomy odpowiedzialności oświadczamy, że niniejszy produkt jest zgodny z następującymi normami lub dokumentacją normatywną: EN 62841-1, EN ISO 12100, EN ISO 13857, EN ISO 13854, EN 28662-1, EN 61000-6-3, EN 61000-6-2, EN 60529, EN 1037 zgodnie z postanowieniami wytycznych 2006/42/EG, 2014/30/EU, 2011/65/EU

(CZ) CE-19 - Prohlášení o shode. Prohlasujeme na vlastní zodpovednosť, že tyto produkty splňují následující normy nebo normativní listiny: EN 62841-1, EN ISO 12100, EN ISO 13857, EN ISO 13854, EN 28662-1, EN 61000-6-3, EN 61000-6-2, EN 60529, EN 1037; Ve shode se smernicami 2006/42/EG, 2014/30/EU, 2011/65/EU

(SLO) CE-19 - Izjava o skladnosti. S tem potrjujemo splošno odgovornost, da je ta izdelek narejen v skladu z navedenimi normami in standardi: EN 62841-1, EN ISO 12100, EN ISO 13857, EN ISO 13854, EN 28662-1, EN 61000-6-3, EN 61000-6-2, EN 60529, EN 1037 ter določbami in smernicami 2006/42/EG, 2014/30/EU, 2011/65/EU

(HR) CE-19 - Izjava o skladnosti. Pod punom odgovornošću izjavljujemo da je proizvod naveden u naslovu ovog dokumenta sukladan sa primijenjenim normama i normativnim dokumentima: EN 62841-1, EN ISO 12100, EN ISO 13857, EN ISO 13854, EN 28662-1, EN 61000-6-3, EN 61000-6-2, EN 60529, EN 1037 u skladu sa odredbama preporuka 2006/42/EG, 2014/30/EU, 2011/65/EU

(H) CE-19 - Megfelelőségi nyilatkozat. Kéziműködtetésű elektromos kéziszerszámok: Teljes felelősséggel kijelentjük, hogy ezek a termékek a következő szabványokkal és irányelvekkel összhangban vannak: EN 62841-1, EN ISO 12100, EN ISO 13857, EN ISO 13854, EN 28662-1, EN 61000-6-3, EN 61000-6-2, EN 60529, EN 1037; és megfelelnek a rendeltetés szerinti 2006/42/EG, 2014/30/EU, 2011/65/EU irányelveknek.

(RO) CE-19 - Declarație de conformitate. Noi declarăm pe propria răspundere că acest produs este în conformitate cu următoarele norme și documente normative: EN 62841-1, EN ISO 12100, EN ISO 13857, EN ISO 13854, EN 28662-1, EN 61000-6-3, EN 61000-6-2, EN 60529, EN 1037; potrivit dispozițiilor directivei 2006/42/EG, 2014/30/EU, 2011/65/EU

Remscheid, 04.10.2021



Joh. - Christoph Schütz

Dipl.-Ing. Joh.-Christoph Schütz, CE-Representative

Handgeführtes batteriebetriebenes Elektrowerkzeug Typ ES 32ISM, ES 32SISM

- (D) CE-'19 - Konformitätserklärung **RED**. Wir erklären in alleiniger Verantwortlichkeit, daß dieses Produkt mit den folgenden Normen oder normativen Dokumenten übereinstimmt: EN 62368-1, EN 301489-1, EN 301489-17, EN 300328 V2.2.2, EN 62479 gemäß den Bestimmungen der Richtlinien 2014/53/EU, 2011/65/EU
- (GB) CE-'19 - Declaration of conformity **RED**. We declare under our sole responsibility that this product is in conformity with the following standards or normative documents: EN 62368-1, EN 301489-1, EN 301489-17, EN 300328 V2.2.2, EN 62479 in accordance with the regulations of directives 2014/53/EU, 2011/65/EU
- (F) CE-'19 - Déclaration de conformité **RED**. Nous déclarons sous notre seule responsabilité que ce produit est en conformité avec les normes ou documents normatifs suivants: EN 62368-1, EN 301489-1, EN 301489-17, EN 300328 V2.2.2, EN 62479 conformément aux réglementations des directives 2014/53/EU, 2011/65/EU
- (E) CE-'19 - Declaración de conformidad **RED**. Declaramos bajo nuestra sola responsabilidad que este producto está en conformidad con las normas o documentos normativos siguientes: EN 62368-1, EN 301489-1, EN 301489-17, EN 300328 V2.2.2, EN 62479 de acuerdo con las regulaciones de las directivas 2014/53/EU, 2011/65/EU
- (I) CE-'19 - Dichiarazione di conformità **RED**. Dichiariamo sotto la nostra esclusiva responsabilità che questo prodotto è conforme alle seguenti norme e documenti normativi: EN 62368-1, EN 301489-1, EN 301489-17, EN 300328 V2.2.2, EN 62479 conformemente alle disposizioni delle direttive 2014/53/EU, 2011/65/EU
- (P) CE-'19 - Declaração de conformidade **RED**. Declaramos sob nossa exclusiva responsabilidade que este produto cumpre as seguintes normas ou documentos normativos: EN 62368-1, EN 301489-1, EN 301489-17, EN 300328 V2.2.2, EN 62479 conforme as disposições das directivas 2014/53/EU, 2011/65/EU
- (NL) CE-'19 - Konformiteitsverklaring **RED**. Wij verklaren en wij stellen ons er alleen voor verantwoordelijk dat dit produkt voldoet aan de volgende normen of normatieve documenten: EN 62368-1, EN 301489-1, EN 301489-17, EN 300328 V2.2.2, EN 62479 overeenkomstig de bepalingen van de richtlijnen 2014/53/EU, 2011/65/EU
- (GR) CE-'19 - ΔΗΛΩΣΗ ΣΥΜΜΟΡΦΩΣΗΣ **M RED**. ε αναληψη συνολικης δηλωσμε: οτι το πορον προιον συμφορει με τα παρακατω ποσυντα και με τα ηροτινα ηου αναφερονται στα σχετικο εγγραφα ε EN 62368-1, EN 301489-1, EN 301489-17, EN 300328 V2.2.2, EN 62479 συμφωνα με τοxη κοινοσημου 2014/53/EU, 2011/65/EU
- (S) CE-'19 - Konformitetsdeklaration **RED**. Vi förklarar på eget ansvar att denna produkt överensstämmer med följande normer eller normativa dokument: EN 62368-1, EN 301489-1, EN 301489-17, EN 300328 V2.2.2, EN 62479 enligt bestämmelserna i direktiverna 2014/53/EU, 2011/65/EU
- (DK) CE-'19 - Konformitetserklæring **RED**. Vi erklærer under almindeligt ansvar at dette produkt er i overensstemmelse med følgende normer eller normative dokumenter: EN 62368-1, EN 301489-1, EN 301489-17, EN 300328 V2.2.2, EN 62479 i henhold til bestemmelserne i direktiverne 2014/53/EU, 2011/65/EU
- (N) CE-'19 - Konformitetserklæring **RED**. Vi erklærer på eget ansvarlighet at dette produkt er i overensstemmelse med følgende standarder eller standard-dokumenter: EN 62368-1, EN 301489-1, EN 301489-17, EN 300328 V2.2.2, EN 62479 i henhold til bestemmelserne i direktive ne 2014/53/EU, 2011/65/EU
- (FIN) CE-'19 - Todistus standardinmukaisuudesta **RED**. Asiasta vastaavana todistamme täten, että tämä tuote on seuraavien standardien ja standardoimisasiakirjojen vaatimusten mukainen: EN 62368-1, EN 301489-1, EN 301489-17, EN 300328 V2.2.2, EN 62479 ja vastaa säädöksiä 2014/53/EU, 2011/65/EU
- (SK) CE-'19 - Prehľadanie o zhode **RED**. Prehlasujeme na vlastnú zodpovednosť, že tieto produkty sú v súlade s nasledovnými normami: EN 62368-1, EN 301489-1, EN 301489-17, EN 300328 V2.2.2, EN 62479 a v zhode so smernicami 2014/53/EU, 2011/65/EU
- (PL) CE-'19 - Zgodność z dyrektywami **RED**. Świadomi odpowiedzialności oświadczamy, że niniejszy produkt jest zgodny z następującymi normami lub dokumentacja normatywna: EN 62368-1, EN 301489-1, EN 301489-17, EN 300328 V2.2.2, EN 62479 zgodnie z postanowieniami wytycznych 2014/53/EU, 2011/65/EU
- (CZ) CE-'19 - Prohlášení o shodě **RED**. Prohlašujeme na vlastní zodpovědnost, že tyto produkty splňují následující normy nebo normativní listiny: EN 62368-1, EN 301489-1, EN 301489-17, EN 300328 V2.2.2, EN 62479 Ve shodě se směrnicemi 2014/53/EU, 2011/65/EU
- (SLO) CE-'19 - Izjava o skladnosti **RED**. S tem potrjujemo splošno odgovornost, da je ta izdelek narejen v skladu z navedenimi normami in standardi EN 62368-1, EN 301489-1, EN 301489-17, EN 300328 V2.2.2, EN 62479 ter dolobčami in smernicami 2014/53/EU, 2011/65/EU
- (HR) CE-'19 - Izjava o sukladnosti **RED**. Pod punom odgovornošću izjavljujemo da je proizvod naveden u naslovu ovog dokumenta sukladan sa primijenjenim normama i normativnim dokumentima : EN 62368-1, EN 301489-1, EN 301489-17, EN 300328 V2.2.2, EN 62479 u skladu sa odredbama preporuka 2014/53/EU, 2011/65/EU
- (H) CE-'19 - Megfelelőségi nyilatkozat **RED**. Kéziműködtetésű elektromos kéziszerszámok. Teljes felelősséggel kijelentjük, hogy ezek a termékek a következő szabványokkal és irányelvekkel összhangban vannak: EN 62368-1, EN 301489-1, EN 301489-17, EN 300328 V2.2.2, EN 62479 és megfelelnek a rendeltetés 2014/53/EU, 2011/65/EU irányelveknek.
- (RO) CE-'19 - Declarație de conformitate **RED**. Noi declarăm pe propria răspundere că acest produs este în conformitate cu următoarele norme și documente normative: EN 62368-1, EN 301489-1, EN 301489-17, EN 300328 V2.2.2, EN 62479 potrivit dispozițiilor directivelor 2014/53/EU, 2011/65/EU

Remscheid, 04.10.2021

CE 
Dipl.-Ing. Joh.-Christoph Schütz, CE-Representative

Handgeführtes batteriebetriebenes Elektrowerkzeug Typ ES 32ISM, ES 32SISM

(D) UKCA-19 - Konformitätserklärung. Wir erklären in alleiniger Verantwortlichkeit, dass dieses Produkt mit den folgenden Normen oder normativen Dokumenten übereinstimmt: BS EN 62841-1, BS EN ISO 12100, BS EN ISO 13857, BS EN ISO 13854, BS EN 28662-1, BS EN 61000-6-3, BS EN 61000-6-2, BS EN 1037 gemäß den Bestimmungen der Richtlinien 2006/42/EG, 2014/30/EU, 2011/65/EU
RED: BS EN IEC 62368-1, EN 301489-1, EN 301489-17, EN 300328 V2.2.2, BS EN 62479 gemäß den Bestimmungen der Richtlinien 2014/53/EU, 2011/65/EU

(GB) UKCA-19 - Declaration of conformity. We declare under our sole responsibility that this product is in conformity with the following standards or normative documents: BS EN 62841-1, BS EN ISO 12100, BS EN ISO 13857, BS EN ISO 13854, BS EN 28662-1, BS EN 61000-6-3, BS EN 61000-6-2, BS EN 1037 in accordance with the regulations of directives 2006/42/EG, 2014/30/EU, 2011/65/EU
RED: BS EN IEC 62368-1, EN 301489-1, EN 301489-17, EN 300328 V2.2.2, BS EN 62479 in accordance with the regulations of directives 2014/53/EU, 2011/65/EU

(F) UKCA-19 - Déclaration de conformité. Nous déclarons sous notre seule responsabilité que ce produit est en conformité avec les normes ou documents normatifs suivants: BS EN 62841-1, BS EN ISO 12100, BS EN ISO 13857, BS EN ISO 13854, BS EN 28662-1, BS EN 61000-6-3, BS EN 61000-6-2, BS EN 1037 conformément aux réglementations des directives 2006/42/EG, 2014/30/EU, 2011/65/EU
RED: BS EN IEC 62368-1, EN 301489-1, EN 301489-17, EN 300328 V2.2.2, BS EN 62479 conformément aux réglementations des directives 2014/53/EU, 2011/65/EU

(E) UKCA-19 - Declaración de conformidad. Declaramos bajo nuestra sola responsabilidad que este producto está en conformidad con las normas o documentos normativos siguientes: BS EN 62841-1, BS EN ISO 12100, BS EN ISO 13857, BS EN ISO 13854, BS EN 28662-1, BS EN 61000-6-3, BS EN 61000-6-2, BS EN 1037 de acuerdo con las regulaciones de las directivas 2006/42/EG, 2014/30/EU, 2011/65/EU
RED: BS EN IEC 62368-1, EN 301489-1, EN 301489-17, EN 300328 V2.2.2, BS EN 62479 de acuerdo con las regulaciones de las directivas 2014/53/EU, 2011/65/EU

(I) UKCA-19 - Dichiarazione di conformità. Dichiariamo sotto la nostra esclusiva responsabilità che questo prodotto è conforme alle seguenti norme e documenti normativi: BS EN 62841-1, BS EN ISO 12100, BS EN ISO 13857, BS EN ISO 13854, BS EN 28662-1, BS EN 61000-6-3, BS EN 61000-6-2, BS EN 1037 conformemente alle disposizioni delle direttive 2006/42/EG, 2014/30/EU, 2011/65/EU
RED: BS EN IEC 62368-1, EN 301489-1, EN 301489-17, EN 300328 V2.2.2, BS EN 62479 conformemente alle disposizioni delle direttive 2014/53/EU, 2011/65/EU

(P) UKCA-19 - Declaração de conformidade. Declaramos sob nossa exclusiva responsabilidade que este produto cumpre as seguintes normas ou documentos normativos: BS EN 62841-1, BS EN ISO 12100, BS EN ISO 13857, BS EN ISO 13854, BS EN 28662-1, BS EN 61000-6-3, BS EN 61000-6-2, BS EN 1037 conforme as disposições das directivas 2006/42/EG, 2014/30/EU, 2011/65/EU
RED: BS EN IEC 62368-1, EN 301489-1, EN 301489-17, EN 300328 V2.2.2, BS EN 62479 conforme as disposições das directivas 2014/53/EU, 2011/65/EU

(NL) UKCA-19 - Konformiteitsverklaring. Wij verklaren en wij stellen ons er alleen voor verantwoordelijk dat dit product voldoet aan de volgende normen of normatieve documenten: BS EN 62841-1, BS EN ISO 12100, BS EN ISO 13857, BS EN ISO 13854, BS EN 28662-1, BS EN 61000-6-3, BS EN 61000-6-2, BS EN 1037 overeenkomstig de bepalingen van de richtlijnen 2006/42/EG, 2014/30/EU, 2011/65/EU
RED: BS EN IEC 62368-1, EN 301489-1, EN 301489-17, EN 300328 V2.2.2, BS EN 62479 overeenkomstig de bepalingen van de richtlijnen 2014/53/EU, 2011/65/EU

(GR) UKCA-19 - Δήλωση Συμμόρφωσης. Με αναλήψη συνολικής δηλωόμενης σε πομπή προιον συμφωνεί με τα παρακάτω πρότυπα και με τα πρότυπα που αναφέρονται στα σχετικά έγγραφα: BS EN 62841-1, BS EN ISO 12100, BS EN ISO 13857, BS EN ISO 13854, BS EN 28662-1, BS EN 61000-6-3, BS EN 61000-6-2, BS EN 1037 σύμφωνα με τους κανονισμούς 2006/42/ΕΓ, 2014/30/ΕΥ, 2011/65/ΕΥ
RED: BS EN IEC 62368-1, EN 301489-1, EN 301489-17, EN 300328 V2.2.2, BS EN 62479 σύμφωνα με τους κανονισμούς 2014/53/ΕΥ, 2011/65/ΕΥ

(S) UKCA-19 - Konformitetsdeklaration. Vi förklarar på eget ansvar att denna produkt överensstämmer med följande normer eller normativa dokument: BS EN 62841-1, BS EN ISO 12100, BS EN ISO 13857, BS EN ISO 13854, BS EN 28662-1, BS EN 61000-6-3, BS EN 61000-6-2, BS EN 1037 enligt bestämmelserna i direktiverna 2006/42/EG, 2014/30/EU, 2011/65/EU
RED: BS EN IEC 62368-1, EN 301489-1, EN 301489-17, EN 300328 V2.2.2, BS EN 62479 enligt bestämmelserna i direktiverna 2014/53/EU, 2011/65/EU

(DK) UKCA-19 - Konformitetserklæring. Vi erklærer under almindeligt ansvar at dette produkt er i overensstemmelse med følgende normer eller normative dokumenter: BS EN 62841-1, BS EN ISO 12100, BS EN ISO 13857, BS EN ISO 13854, BS EN 28662-1, BS EN 61000-6-3, BS EN 61000-6-2, BS EN 1037 i henhold til bestemmelserne i direktivene 2006/42/EF, 2014/30/EU, 2011/65/EU
RED: BS EN IEC 62368-1, EN 301489-1, EN 301489-17, EN 300328 V2.2.2, BS EN 62479 i henhold til bestemmelserne i direktivene 2014/53/EU, 2011/65/EU

(N) UKCA-19 - Konformitetserklæring. Vi erklærer på eget ansvarlighet at dette produkt er i overensstemmelse med følgende standarder eller standard-dokumenter: BS EN 62841-1, BS EN ISO 12100, BS EN ISO 13857, BS EN ISO 13854, BS EN 28662-1, BS EN 61000-6-3, BS EN 61000-6-2, BS EN 1037 i henhold til bestemmelserne i direktive ne 2006/42/EF, 2014/30/EU, 2011/65/EU
RED: BS EN IEC 62368-1, EN 301489-1, EN 301489-17, EN 300328 V2.2.2, BS EN 62479 i henhold til bestemmelserne i direktive ne 2014/53/EU, 2011/65/EU

(FI) UKCA-19 - Todistus standardinmukaissuudesta. Asiasta vastaava todistamme lähten, että tämä tuote on seuraavien standardien ja standardomissa asiakirjojen vaatimusten mukainen: BS EN 62841-1, BS EN ISO 12100, BS EN ISO 13857, BS EN ISO 13854, BS EN 28662-1, BS EN 61000-6-3, BS EN 61000-6-2, BS EN 1037 ja vastaa sääöksia 2006/42/EG, 2014/30/EU, 2011/65/EU
RED: BS EN IEC 62368-1, EN 301489-1, EN 301489-17, EN 300328 V2.2.2, BS EN 62479 ja vastaa sääöksia 2014/53/EU, 2011/65/EU

(SK) UKCA-19 - Prehlásenie o zhode. Prehlasujeme na vlastnú zodpovednosť, že tieto produkty sú v súlade s nasledovnými normami: BS EN 62841-1, BS EN ISO 12100, BS EN ISO 13857, BS EN ISO 13854, BS EN 28662-1, BS EN 61000-6-3, BS EN 61000-6-2, BS EN 1037 a v zhode so smernicami 2006/42/EG, 2014/30/EU, 2011/65/EU
RED: BS EN IEC 62368-1, EN 301489-1, EN 301489-17, EN 300328 V2.2.2, BS EN 62479 a v zhode so smernicami 2014/53/EU, 2011/65/EU

(PL) UKCA-19 - Zgodność z dyrektywami UKCA. Świadcimy odpowiedzialności oświadczamy, że niniejszy produkt jest zgodny z następującymi normami lub dokumentacją normatywną: BS EN 62841-1, BS EN ISO 12100, BS EN ISO 13857, BS EN ISO 13854, BS EN 28662-1, BS EN 61000-6-3, BS EN 61000-6-2, BS EN 1037 zgodnie z postanowieniami wytycznych 2006/42/EG, 2014/30/EU, 2011/65/EU
RED: BS EN IEC 62368-1, EN 301489-1, EN 301489-17, EN 300328 V2.2.2, BS EN 62479 zgodnie z postanowieniami wytycznych 2014/53/EU, 2011/65/EU

(CZ) UKCA-19 - Prohlášení o shodě. Prohlášíme na vlastní zodpovědnost, že tyto produkty splňují následující normy nebo normativní listiny: BS EN 62841-1, BS EN ISO 12100, BS EN ISO 13857, BS EN ISO 13854, BS EN 28662-1, BS EN 61000-6-3, BS EN 61000-6-2, BS EN 1037 ve shodě se směrnicemi 2006/42/EG, 2014/30/EU, 2011/65/EU
RED: BS EN IEC 62368-1, EN 301489-1, EN 301489-17, EN 300328 V2.2.2, BS EN 62479 ve shodě se směrnicemi 2014/53/EU, 2011/65/EU

(SLO) UKCA-19 - Izjava o skladnosti. S tem potrjujemo splošno odgovornost, da je izdelek narejen v skladu z navedenimi normami in standardi: BS EN 62841-1, BS EN ISO 12100, BS EN ISO 13857, BS EN ISO 13854, BS EN 28662-1, BS EN 61000-6-3, BS EN 61000-6-2, BS EN 1037 ter določbami in smernicami 2006/42/EG, 2014/30/EU, 2011/65/EU
RED: BS EN IEC 62368-1, EN 301489-1, EN 301489-17, EN 300328 V2.2.2, BS EN 62479 ter določbami in smernicami 2014/53/EU, 2011/65/EU

(HR) UKCA-19 - Izjava o skladnosti. Pod punom odgovornošću izjavljujemo da je proizvod naveden u naslovu ovog dokumenta skladan sa primjenjenim normama i normativnim dokumentima: BS EN 62841-1, BS EN ISO 12100, BS EN ISO 13857, BS EN ISO 13854, BS EN 28662-1, BS EN 61000-6-3, BS EN 61000-6-2, BS EN 1037 u skladu sa odredbama preporuka 2006/42/EG, 2014/30/EU, 2011/65/EU
RED: BS EN IEC 62368-1, EN 301489-1, EN 301489-17, EN 300328 V2.2.2, BS EN 62479 u skladu sa odredbama preporuka 2014/53/EU, 2011/65/EU

(H) UKCA-19 - Megfelelőségi nyilatkozat. Kéziműködésű elektromos kéziszerszámok: Teljes felelősséggel kijelentjük, hogy ezek a termékek a következő szabványokkal és irányelvekkel összhangban vannak: BS EN 62841-1, BS EN ISO 12100, BS EN ISO 13857, BS EN ISO 13854, BS EN 28662-1, BS EN 61000-6-3, BS EN 61000-6-2, BS EN 1037, és megfelelnek a rendelkezés szerinti 2006/42/EG, 2014/30/EU, 2011/65/EU irányelveknek.
RED: BS EN IEC 62368-1, EN 301489-1, EN 301489-17, EN 300328 V2.2.2, BS EN 62479 és megfelelnek a rendelkezés szerinti 2014/53/EU, 2011/65/EU irányelveknek.

(RO) UKCA-19 - Declarație de conformitate. Noi declarăm pe propria răspundere că acest produs este în conformitate cu următoarele norme și documente normative: BS EN 62841-1, BS EN ISO 12100, BS EN ISO 13857, BS EN ISO 13854, BS EN 28662-1, BS EN 61000-6-3, BS EN 61000-6-2, BS EN 1037; potrivit dispozițiilor directivelor 2006/42/EG, 2014/30/EU, 2011/65/EU
RED: BS EN IEC 62368-1, EN 301489-1, EN 301489-17, EN 300328 V2.2.2, BS EN 62479 potrivit dispozițiilor directivelor 2014/53/EU, 2011/65/EU



Joh. - Christoph Schütz

Dipl.-Ing. Joh. Christoph Schütz, CE-Representative