

Montageanleitung

Ⓒ mounting instruction Ⓕ Notice de montage Ⓖ Instrukcja montaży
Ⓔ Instrucciones de montaje ⓘ Istruzioni di montaggio

EL-A...ML

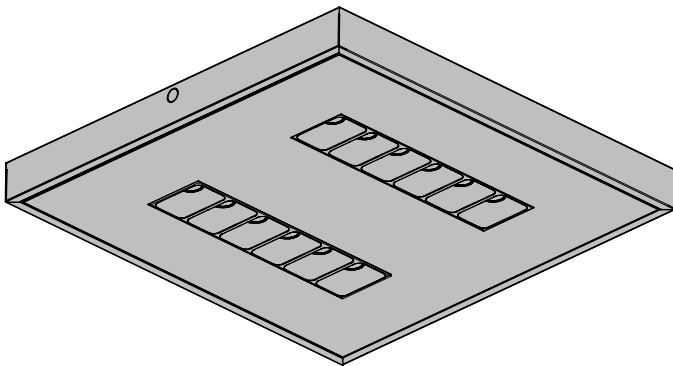

RIDI Leuchten GmbH
Hauptstrasse 31 - 33 · D-72417 Jungingen
Tel. 07477/872-0 · Fax 07477/872-48
kontakt@ridi.de · www.ridi.de



- (D) Für die Installation und für den Betrieb der Leuchten sind die nationalen Sicherheitsvorschriften zu beachten.
- (GB) Please note national safety instructions for installation and operation of this luminaire.
- (F) Pour l'installation et le fonctionnement des luminaires il est impératif de respecter les normes nationales de sécurité en vigueur.
- (PL) W celu prawidłowej instalacji i poprawnego działania oprawy należy przestrzegać krajowych przepisów bezpieczeństwa.
- (E) Para la instalación y la puesta en funcionamiento de las luminarias deben observarse las normas nacionales de seguridad.
- (I) Per l'installazione e il funzionamento delle lampade si fa riferimento alle normative di sicurezza nazionali.



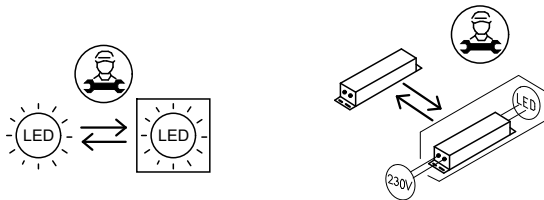
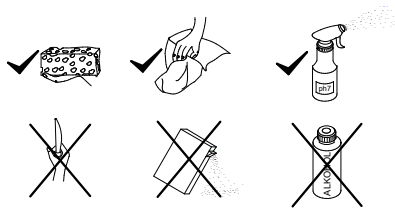







- (D) Die Lichtquelle dieser Leuchte darf nur vom Hersteller oder einem von ihm beauftragten Servicetechniker oder einer vergleichbar qualifizierten Person ersetzt werden.
- (GB) Only the manufacturer, a trained service technician or another equally qualified person is permitted to replace the light source of this luminaire.
- (F) La source lumineuse de ce luminaire ne peut être remplacée que par le fabricant, un technicien de service mandaté par celui-ci ou une personne présentant une qualification analogue.
- (PL) Wymiany źródła światła w tej oprawie oświetleniowej może dokonać wyłącznie producent bądź uprawniony pracownik serwisu albo osoba o podobnych kwalifikacjach.
- (E) La fuente de luz de esta luminaria solamente podrá ser sustituida por el fabricante o una persona designada por este, ya sea un técnico de servicio u otra persona debidamente cualificada.
- (I) La sorgente luminosa di tale lampada può essere sostituita solo dal produttore o da un tecnico di assistenza da questi designato oppure da personale dotato di qualifica equivalente.









Druckfehler und Irrtum vorbehalten.
Formelle und technische Änderungen behalten wir uns vor.

Misprints and errors excepted.
We reserve the right of formal and technical modifications.









EL-AS...ML

Typ	L	B	A1	A2	K	K1	K2	K3			4/9
1197...	1205	187	900	--	L/2	490	65	44			Ⓘ
1247...	1255		950								Ⓘ
1497...	1505		1200							Ⓘ	
1547...	1555		1250							Ⓘ	

EL-AE...ML

Typ	L	B	A1	A2	K	K1	K2	K3			4/9
1197...	1205	301	900	132 / B/2	--	22	--	22			Ⓔ
1497...	1505		1200		L/2	--		44	365		Ⓕ
1247...	1255	314	950		--	22		22	460		Ⓔ
1547...	1555		1250		L/2	--		44	485		Ⓕ

EL-AQ...ML

Typ	L	B	A1	A2	K	K1	K2	K3			5/9
0310...	318	318	150	--	L/2	--	--	30			Ⓖ
0483...	491	491	285	149			74,5		215		Ⓗ
0597...	605	601	400	435		194	--	44			Ⓗ
0622...	630	626									Ⓗ

EL-AS...ML

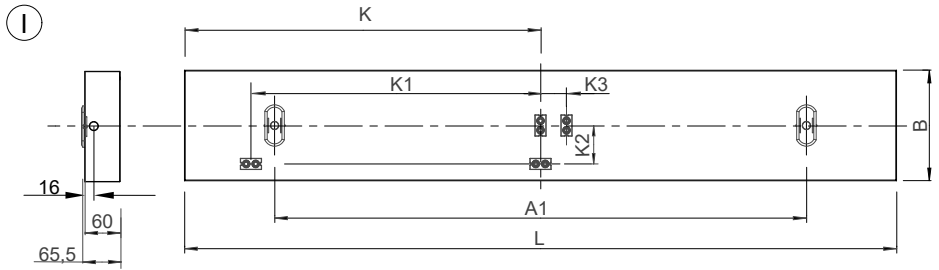

EL-AE...ML

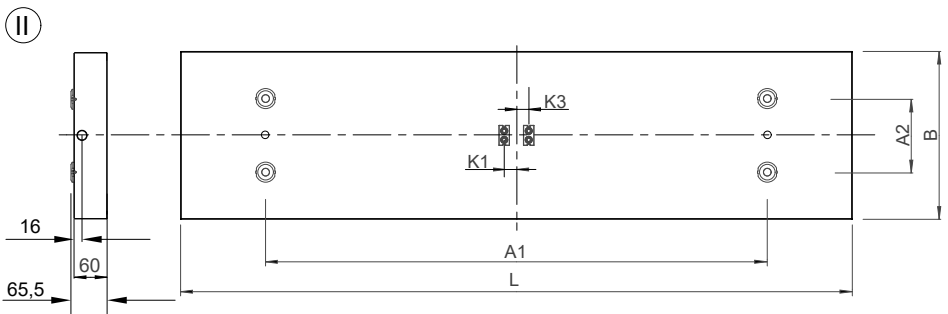

EL-AE...ML

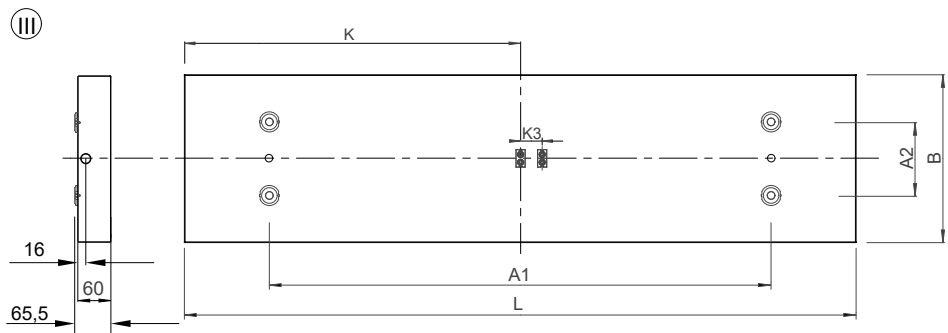

EL- AQ...ML

IV

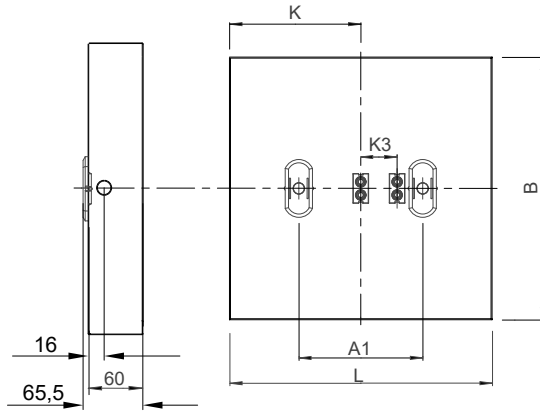

EL- AQ...ML

V

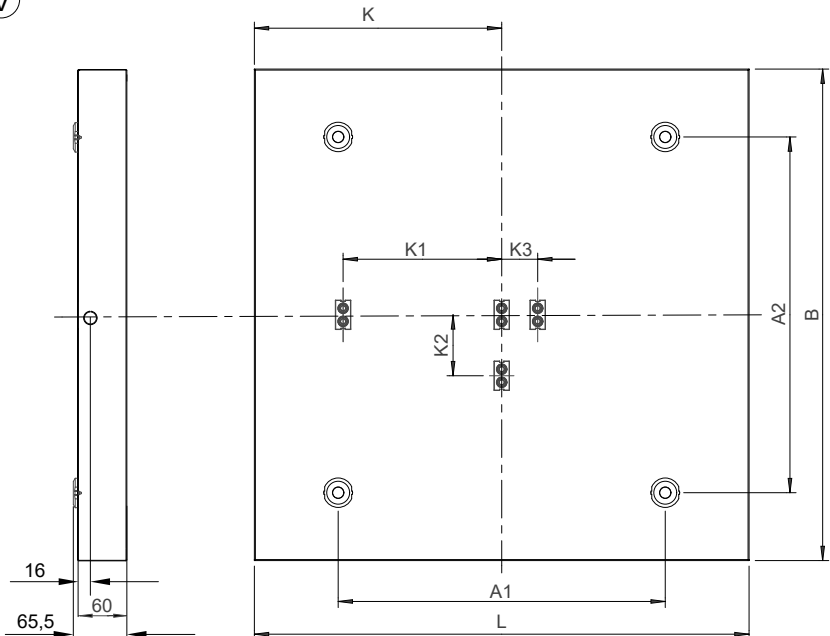

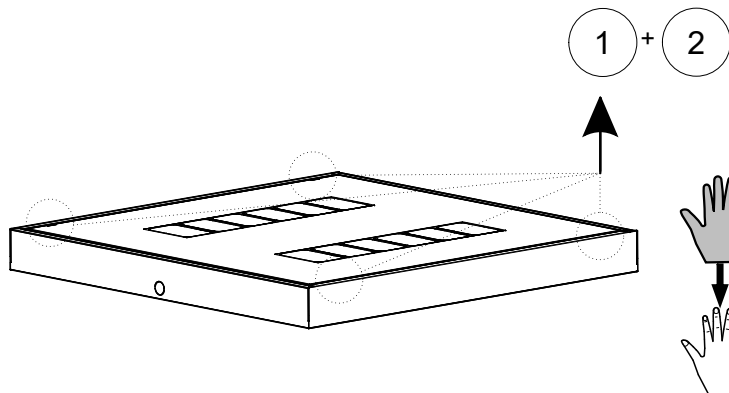

bauseits
to be supplied at site
A prévoir sur place
Prever a la red
we własnym zakresie
a cura del cliente

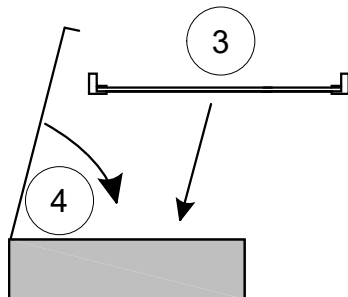
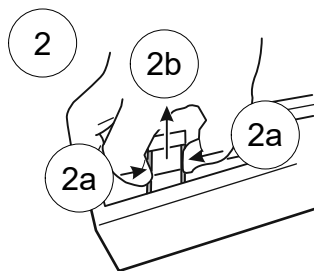
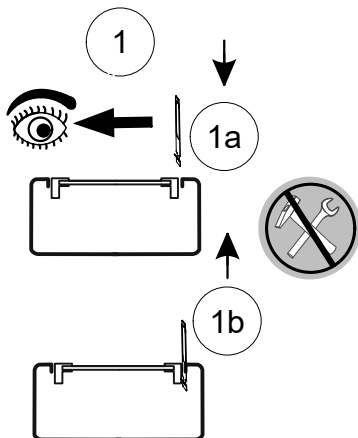

EL-AS...ML
EL-AE...ML
EL-AQ...ML

bauseits
to be supplied on-site
À prévoir sur place
we własnym zakresie
por parte del cliente
a cura del cliente

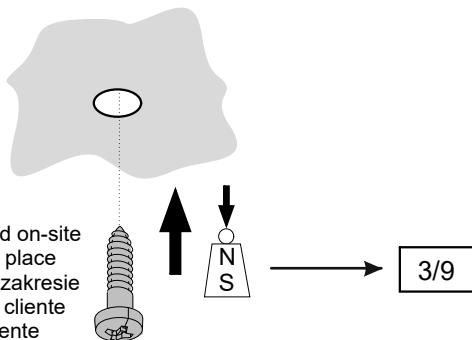

EL-AS...ML

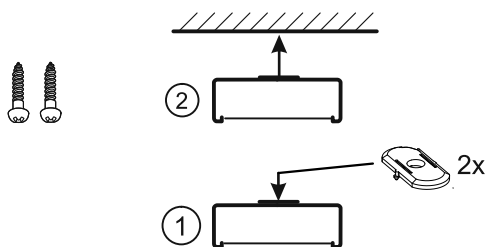

EL-AE...ML
EL-AQ...ML

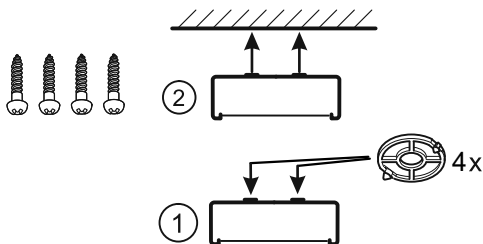

EL-AS...ML
EL-AE...ML
EL-AQ...ML

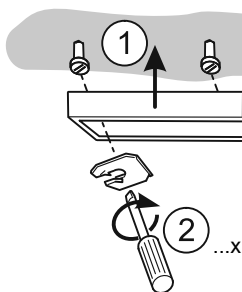

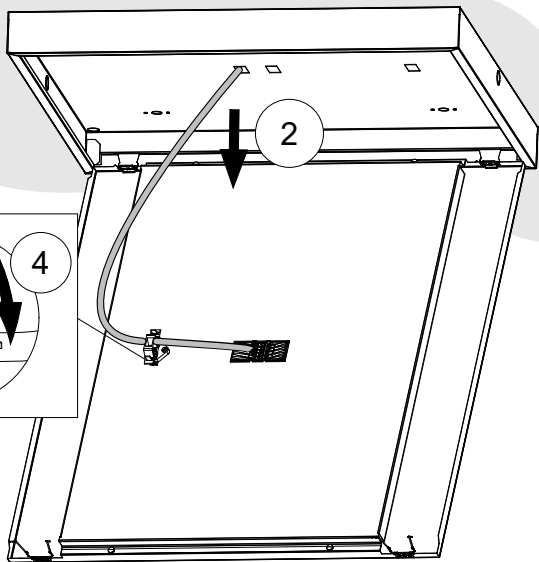
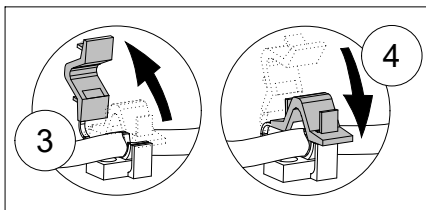
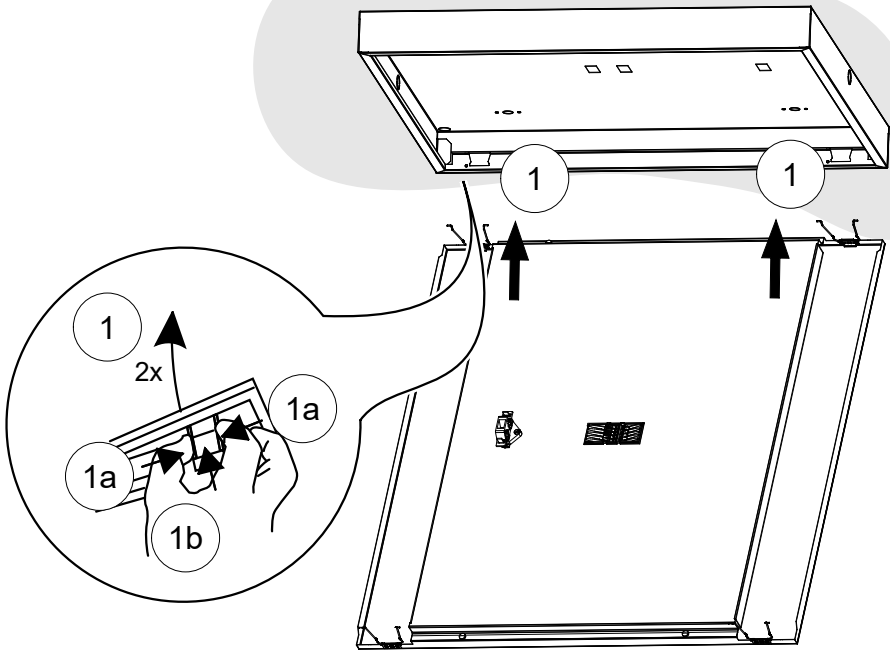

	Ø	A
	0,8-1,2	9
max. ø1,8mm	1,3-1,8	12

	mm²	A
sol.	0,5-1,0	9
0,5-2,5mm²	1,5-2,5	12

	mm²	A
	0,8-1,2	9
max. ø1,8mm	1,3-1,8	12

abisolieren
stripping
10mm max.

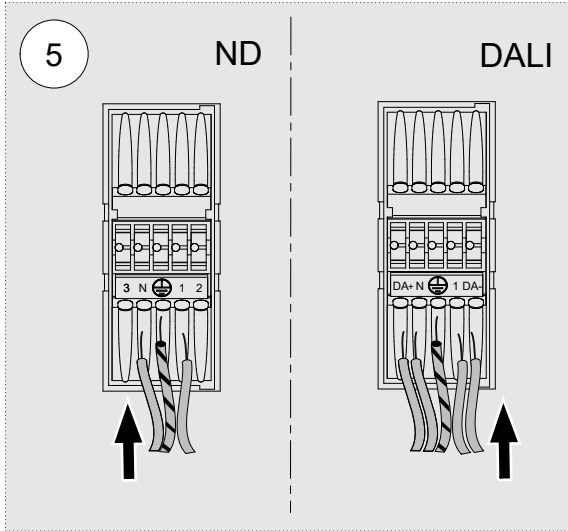
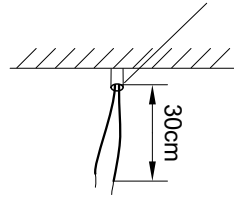

VOLT ?



RIDI

.....

~ ...V/...Hz

