

# Technical Data sheet

## *EasyLan<sup>®</sup> LWL Distribution Boxes / Splice Boxes*

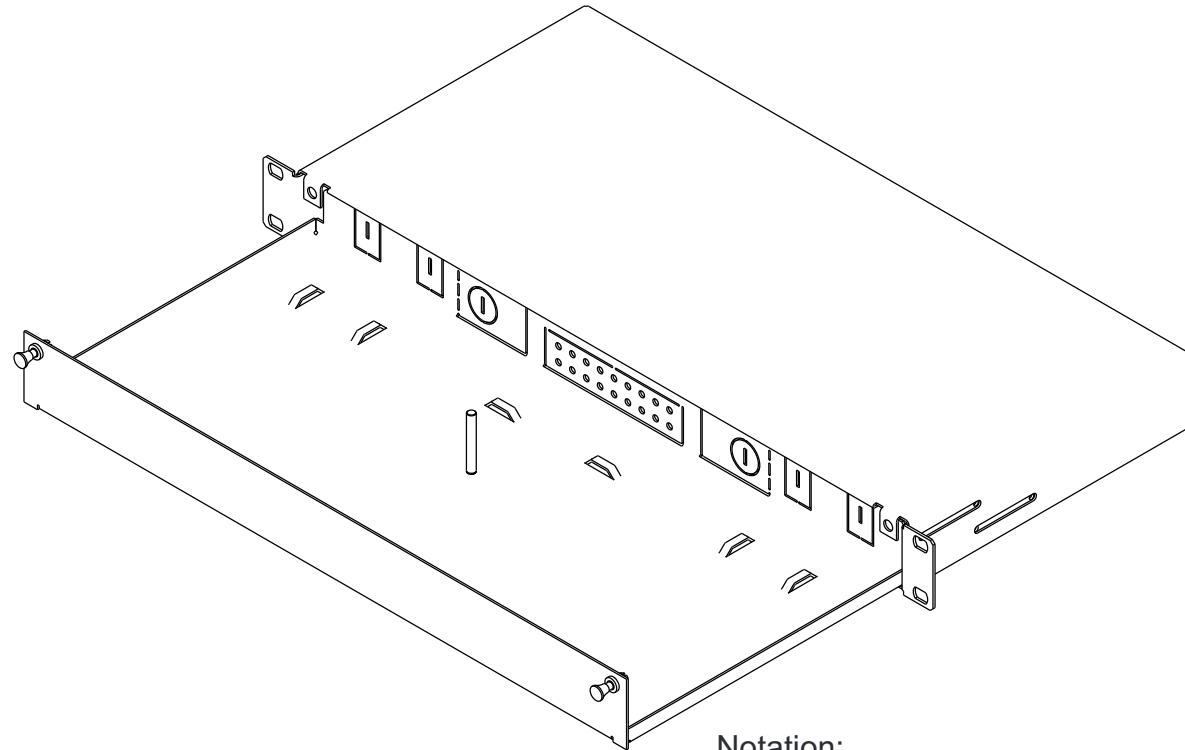

Notation:  
You can find EasyLan<sup>®</sup> Quality Standards on separate data sheet

c	Ergänzung/ Umänderung	15.04.2024	TG	drawn	16.07.2018	LP
				b	Änderung	08.12.2021
a	Neuerstellung	16.07.2018	LP	appr.	16.07.2018	MJ
Index				Title:		
Revision Code				EasyLan <sup>®</sup> FO Distribution Boxes / Splice Boxes		
Date				Drawing Number:		
Name				ZN-FO181416		
				 <b>EasyLan<sup>®</sup></b> <i>...for a better connectivity</i>		
				Dimensions: mm		
				Original: DIN A4		
				Sheet 1 of 14		

Material powder-coated steel

# EasyLan<sup>®</sup> LWL Distribution Boxes / Splice Boxes

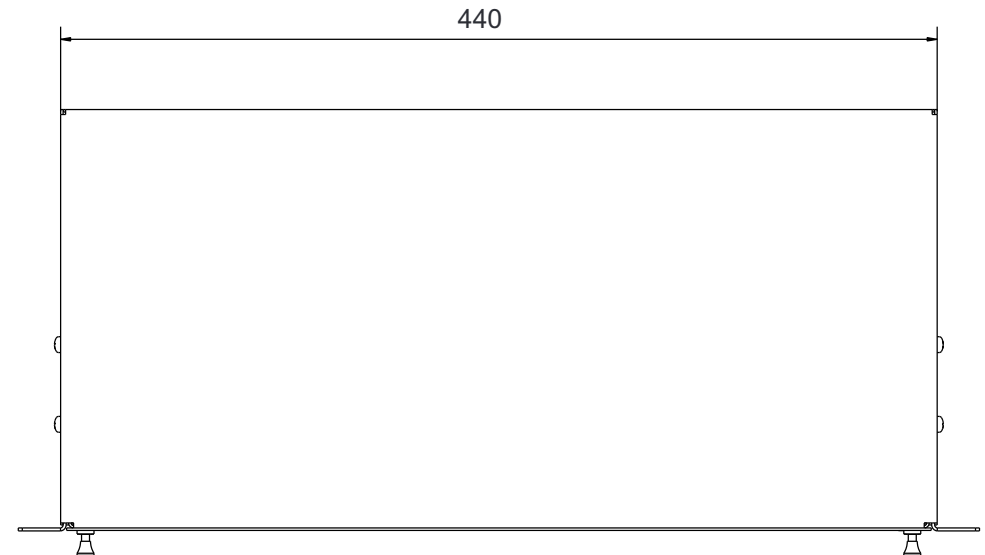
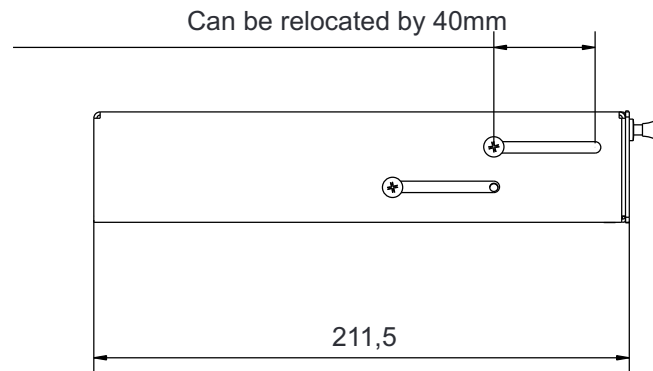
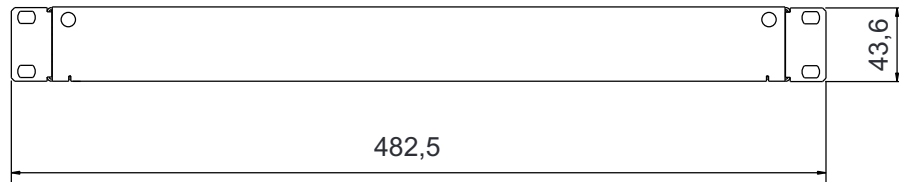

View: Back Side

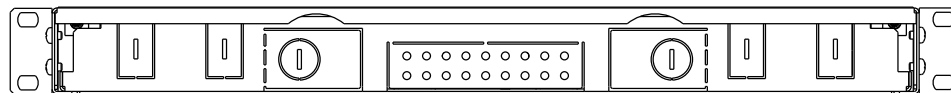

c	Ergänzung/ Umänderung	15.04.2024	TG	drawn	16.07.2018	LP
				b	Änderung	08.12.2021
a	Neuerstellung	16.07.2018	LP	appr.	16.07.2018	MJ
Index				Title:		
Revision Code				EasyLan <sup>®</sup> FO Distribution Boxes / Splice Boxes		
Date				Drawing Number:		
Name				ZN-FO181416		
				 ...for a better connectivity		
				Dimensions: mm		
				Original: DIN A4		
				Sheet 2 of 14		

Material powder-coated steel

# EasyLan<sup>®</sup> FO Front Plate 12x LC-Duplex / SC-Simplex

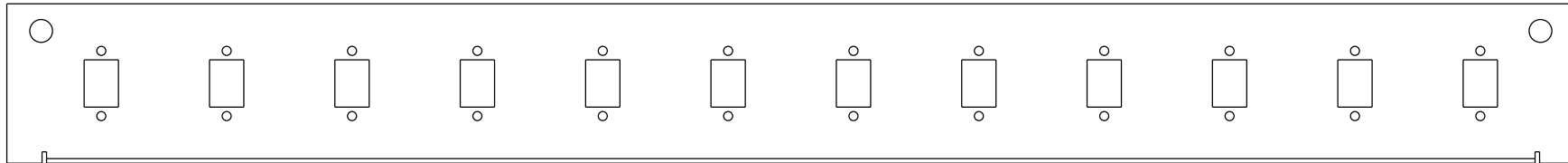

## Possible Assembly:

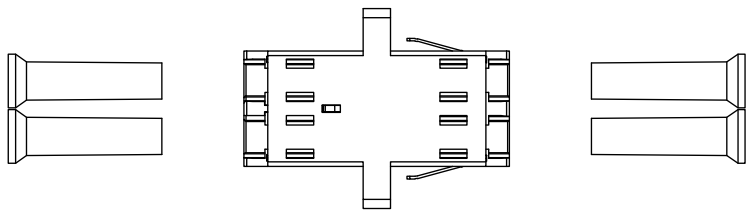

LC-Duplex, Grade C

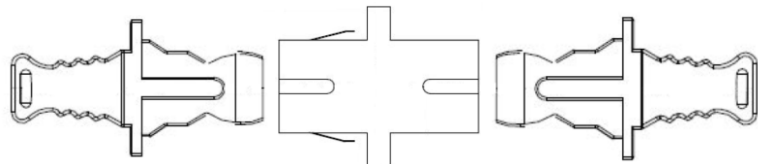

SC-Simplex, Grade B

## Notation:

You can find EasyLan<sup>®</sup> Quality Standards on separate data sheet

c b a	Ergänzung/ Umänderung Änderung Neuerstellung	15.04.2024 08.12.2021 16.07.2018	TG MW LP	drawn	16.07.2018	LP
				appr.	16.07.2018	MJ
Index				Titel:		
Revision Code				EasyLan <sup>®</sup> FO Distribution Boxes / Splice Boxes		
Date				Drawing Number:		
Name				ZN-FO181416		
						
				Dimensions: mm		
				Original: DIN A4		
				Sheet 3 of 14		

# EasyLan<sup>®</sup> FO Front Plate 12x LC-Duplex Snap-In

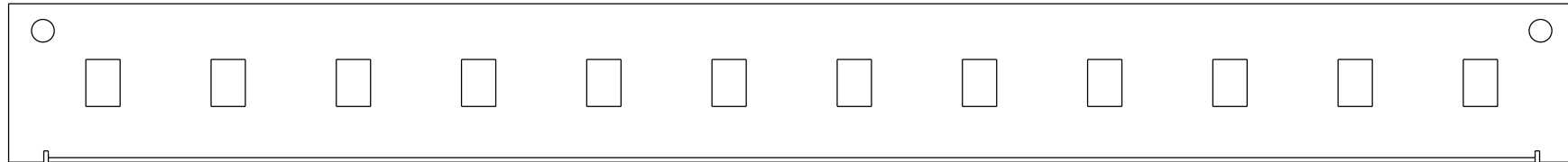

## Possible Assembly:

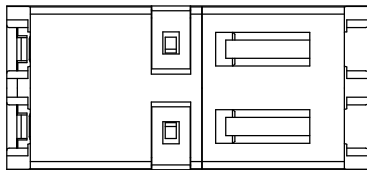

LC-Duplex, Grade B+

## Notation:

You can find EasyLan<sup>®</sup> Quality Standards on separate data sheet

				drawn	16.07.2018	LP
				appr.	16.07.2018	MJ
c b a	Ergänzung/ Umänderung Änderung Neuerstellung	15.04.2024 08.12.2021 16.07.2018	TG MM LP	Titel:		
				EasyLan <sup>®</sup> FO Distribution Boxes / Splice Boxes		
Index				Drawing Number:		
				ZN-FO181416		
				 <b>EasyLan<sup>®</sup></b> ...for a better connectivity		
				Dimensions: mm		
				Original: DIN A4		
				Sheet 4 of 14		

# EasyLan<sup>®</sup> FO Front Plate 24x LC-Duplex / SC-Simplex

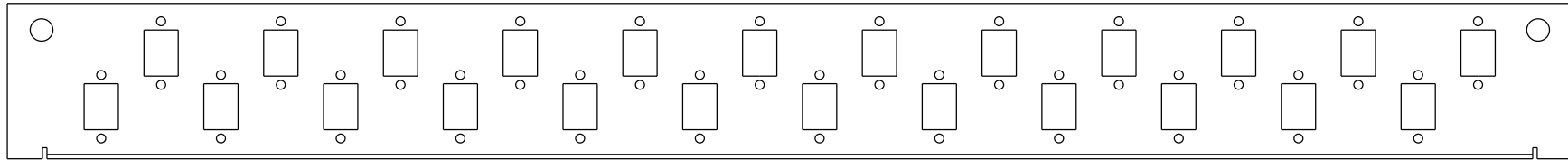

## Possible Assembly:

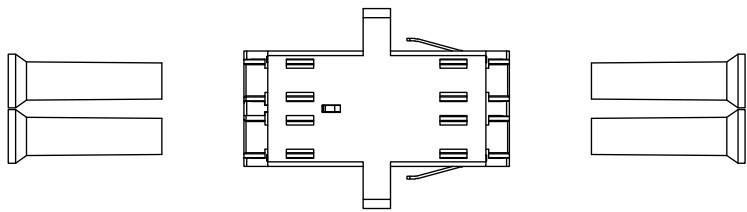

LC-Duplex, Grade C

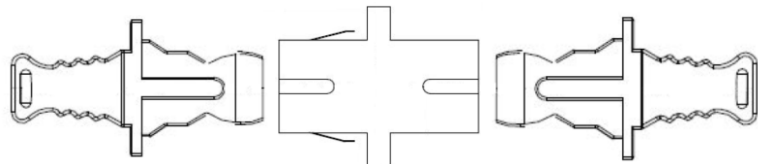

SC-Simplex, Grade B

## Notation:

You can find EasyLan<sup>®</sup> Quality Standards on separate data sheet

c b a	Ergänzung/ Umänderung Änderung Neuerstellung	15.04.2024 08.12.2021 16.07.2018	TG MW LP	drawn	16.07.2018	LP
				appr.	16.07.2018	MJ
Index				Titel:		
Revision Code				EasyLan <sup>®</sup> FO Distribution Boxes / Splice Boxes		
Date				Drawing Number:		
Name				ZN-FO181416		
						
				Dimensions: mm		
				Original: DIN A4		
				Sheet 5 of 14		

# EasyLan<sup>®</sup> FO Front Plate 24x LC-Duplex Snap-In

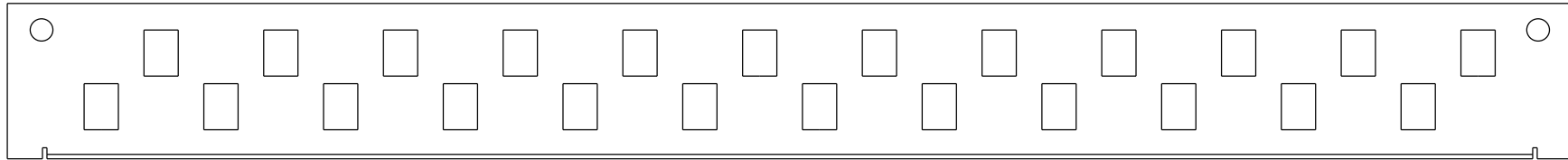

## Possible Assembly:

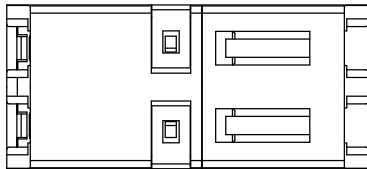

LC-Duplex, Grade B+

## Notation:

You can find EasyLan<sup>®</sup> Quality Standards on separate data sheet

c	Ergänzung/ Umänderung	15.04.2024	TG	drawn	16.07.2018	LP	
				b	Änderung	08.12.2021	
a	Neuerstellung	16.07.2018	LP	Titel: EasyLan <sup>®</sup> FO Distribution Boxes / Splice Boxes			Dimensions: mm
Index				Revision Code	Date	Name	Original: DIN A4
				Drawing Number: <b>ZN-FO181416</b>			Sheet 6 of 14

# EasyLan® FO Front Plate 12x SC-Duplex / LC-Quad

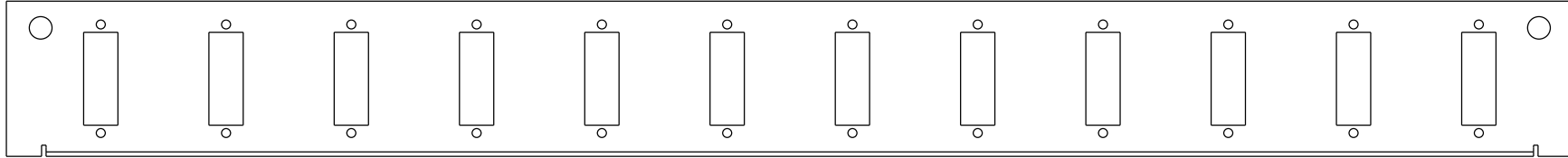

## Possible Assembly:

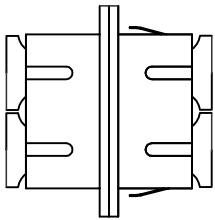

SC-Duplex, Grade C

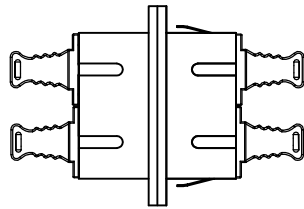

SC-Duplex, Grade B+

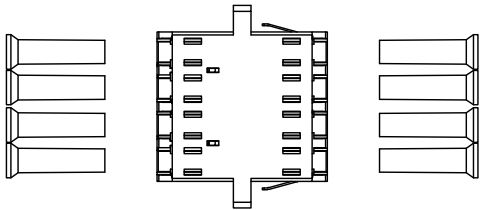

LC-Quad, Grade C

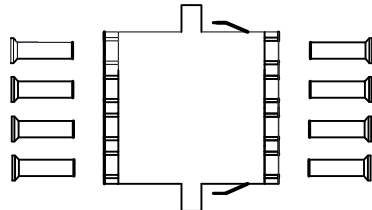

LC-Quad, Grade B

## Notation:

You can find EasyLan® Quality Standards on separate data sheet

c b a	Ergänzung/ Umänderung Änderung Neuerstellung	15.04.2024 08.12.2021 16.07.2018	TG MW LP	drawn	16.07.2018	LP
				appr.	16.07.2018	MJ
Index				Titel:		
Revision Code				EasyLan® FO Distribution Boxes / Splice Boxes		
Date				Drawing Number:		
Name				ZN-FO181416		
						
				Dimensions: mm		
				Original: DIN A4		
				Sheet 7 of 14		

# EasyLan<sup>®</sup> FO Front Plate 12x LC-Quad Snap-In

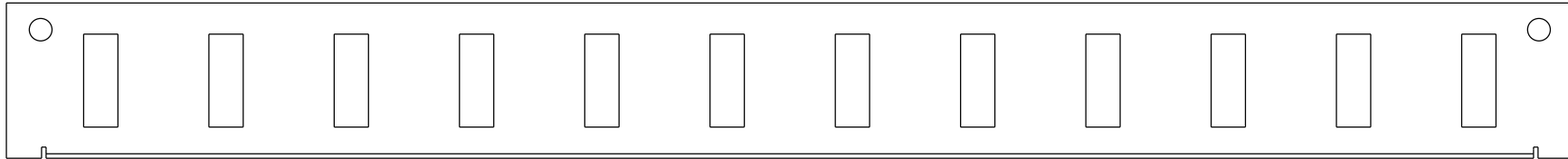

Possible Assembly:

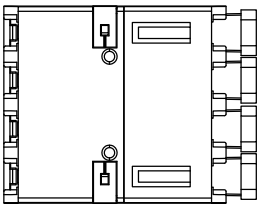

LC-Quad, Grade B+

Notation:

You can find EasyLan<sup>®</sup> Quality Standards on separate data sheet

				drawn	16.07.2018	LP
				appr.	16.07.2018	MJ
c b a	Ergänzung/ Umänderung Änderung Neuerstellung	15.04.2024 08.12.2021 16.07.2018	TG MM LP	Titel:		
				EasyLan <sup>®</sup> FO Distribution Boxes / Splice Boxes		
Index	Revision Code	Date	Name	Drawing Number: <b>ZN-FO181416</b>		
				 <b>EasyLan<sup>®</sup></b> ...for a better connectivity		Dimensions: mm
						Original: DIN A4
						Sheet 8 of 14



# EasyLan<sup>®</sup> FO Front Plate 24x SC-Duplex / LC-Quad

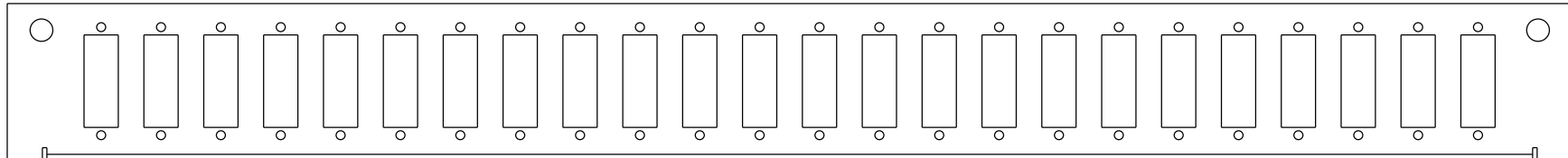

## Possible Assembly:

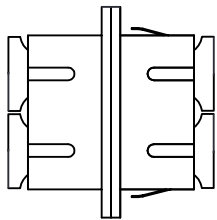

SC-Duplex, Grade C

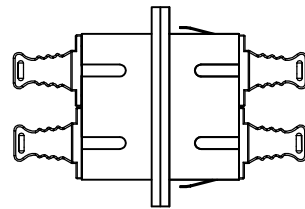

SC-Duplex, Grade B+

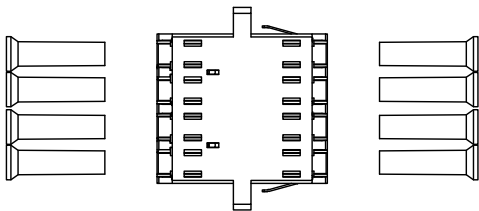

LC-Quad, Grade C

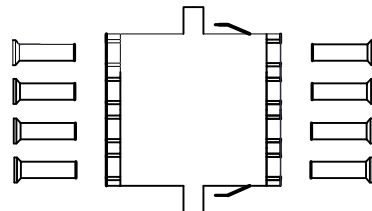

LC-Quad, Grade B

## Notation:

You can find EasyLan<sup>®</sup> Quality Standards on separate data sheet

c b a	Ergänzung/ Umänderung Änderung Neuerstellung	15.04.2024 08.12.2021 16.07.2018	TG MW LP	drawn	16.07.2018	LP
				appr.	16.07.2018	MJ
Index				Titel:		
Revision Code				EasyLan <sup>®</sup> FO Distribution Boxes / Splice Boxes		
Date				Drawing Number:		
Name				ZN-FO181416		
				 <b>EasyLan<sup>®</sup></b> ...for a better connectivity		
				Dimensions: mm		
				Original: DIN A4		
				Sheet 9 of 14		

# EasyLan<sup>®</sup> FO Front Plate 24x LC-Quad Snap-In

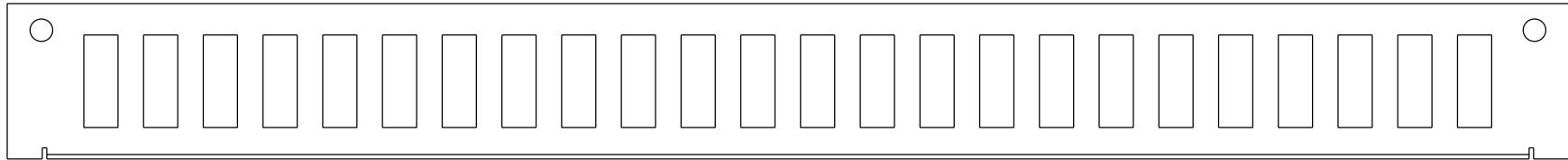

## Possible Assembly:

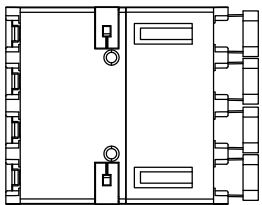

LC-Quad, Grade B+

## Notation:

You can find EasyLan<sup>®</sup> Quality Standards on separate data sheet

				drawn	16.07.2018	LP
				appr.	16.07.2018	MJ
c b a	Ergänzung/ Umänderung Änderung Neuerstellung	15.04.2024 08.12.2021 16.07.2018	TG MM LP	Titel:		
				EasyLan <sup>®</sup> FO Distribution Boxes / Splice Boxes		
Index	Revision Code	Date	Name	Drawing Number: <b>ZN-FO181416</b>		
				 <b>EasyLan<sup>®</sup></b> ...for a better connectivity		Dimensions: mm
						Original: DIN A4
						Sheet 10 of 14

# EasyLan<sup>®</sup> Front Plate 12x E2000<sup>®</sup> / LSH Compact

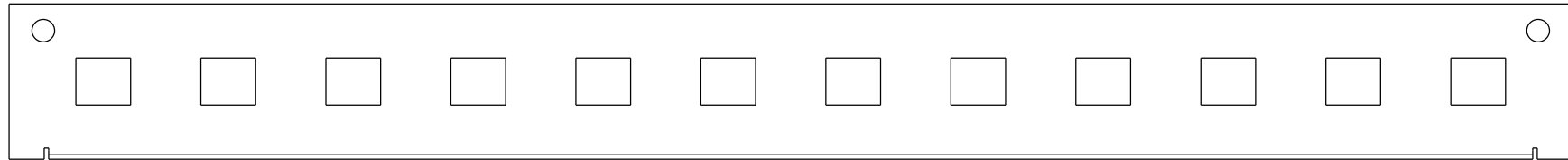

Possible Assembly:

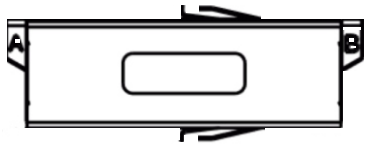

E2000<sup>®</sup> Compact (H&S),  
Grade B



LSH Compact (ZVK),  
Grade B

Notation:

You can find EasyLan<sup>®</sup> Quality Standards on separate data sheet

c	Ergänzung/ Umänderung	15.04.2024	TG	drawn	16.07.2018	LP
				b	Änderung	08.12.2021
a	Neuerstellung	16.07.2018	LP	appr.	16.07.2018	MJ
Index				Title:		
Revision Code				EasyLan <sup>®</sup> FO Distribution Boxes / Splice Boxes		
Date				Drawing Number:		
Name				ZN-FO181416		
						
				Dimensions: mm		
				Original: DIN A4		
				Sheet 11 of 14		

# EasyLan<sup>®</sup> FO Front Plate 24x E2000<sup>®</sup> / LSH Compact

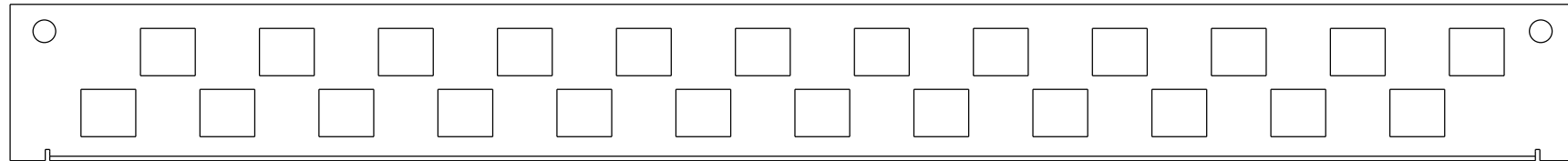

Possible Assembly:

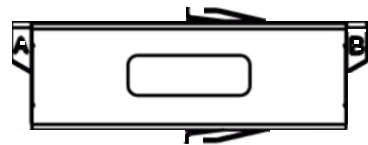

E2000<sup>®</sup> Compact (H&S),  
Grade B



LSH Compact (ZVK),  
Grade B

Notation:

You can find EasyLan<sup>®</sup> Quality Standards on separate data sheet

	drawn	16.07.2018	LP
		appr.	16.07.2018
Titel: EasyLan <sup>®</sup> FO Distribution Boxes / Splice Boxes			
Drawing Number: <b>ZN-FO181416</b>			
c	Ergrünung/ Umänderung	15.04.2024	TG
b	Änderung	08.12.2021	MW
a	Neuerstellung	16.07.2018	LP
Index	Revision Code	Date	Name
Dimensions: mm			
Original: DIN A4			
Sheet 12 of 14			

# EasyLan® FO Front Plate 12x ST / FC

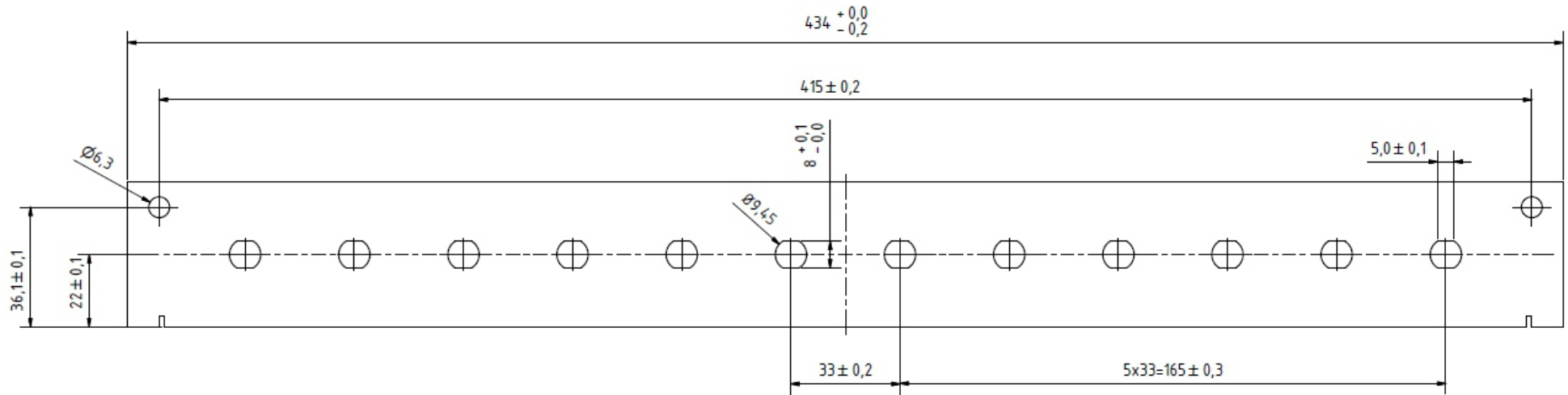

Notation:  
You can find EasyLan® Quality Standards on separate data sheet

				drawn	16.07.2018	LP
				appr.	16.07.2018	MJ
c b a	Ergänzung/ Umänderung Änderung Neuerstellung	15.04.2024 08.12.2021 16.07.2018	TG MW LP	Titel:		
				EasyLan® FO Distribution Boxes / Splice Boxes		
Index	Revision Code	Date	Name	Drawing Number: <b>ZN-FO181416</b>		
				 <b>EasyLan®</b> ...for a better connectivity		
				Dimensions: mm		
				Original: DIN A4		
				Sheet 13 of 14		

# EasyLan® FO Front Plate 24x ST / FC

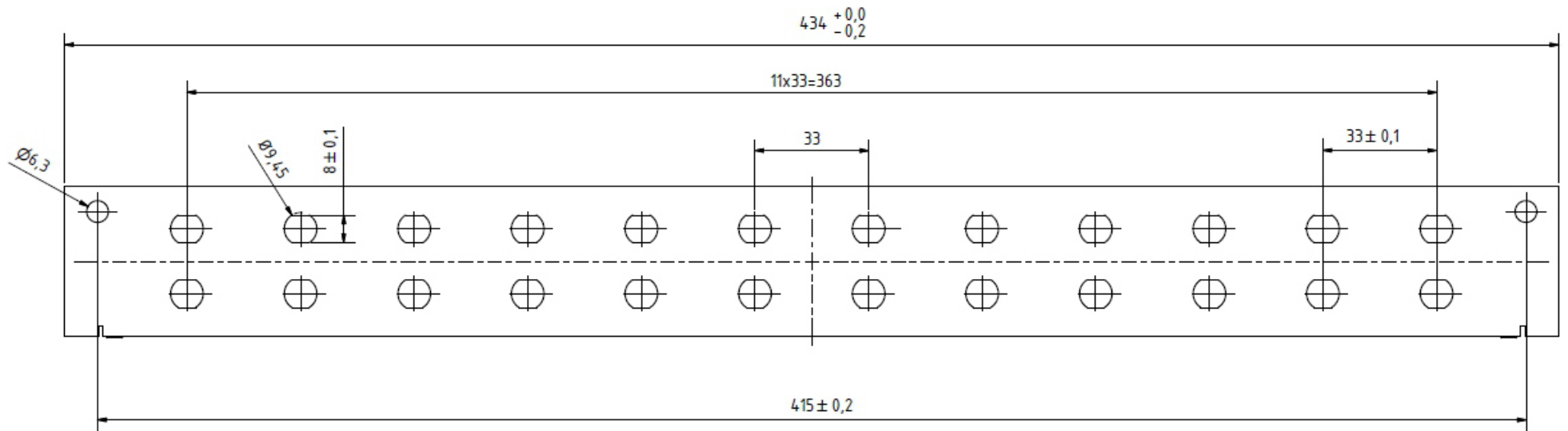

Notation:

You can find EasyLan® Quality Standards on separate data sheet

c b a	Ergänzung/ Umänderung Änderung Neuerstellung	15.04.2024 08.12.2021 16.07.2018	TG MM LP	drawn	16.07.2018	LP
				appr.	16.07.2018	MJ
				Titel: EasyLan® FO Distribution Boxes / Splice Boxes		
				Drawing Number: <b>ZN-FO181416</b>		
Index	Revision Code	Date	Name	 <b>EasyLan®</b> ...for a better connectivity		
				Dimensions: mm		
				Original: DIN A4		
				Sheet 14 of 14		