

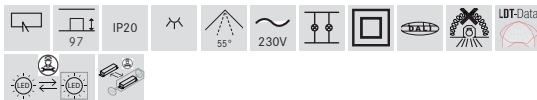

APOLLO MEGA LED recessed downlight, square, DALI
Article no. 41645174DA

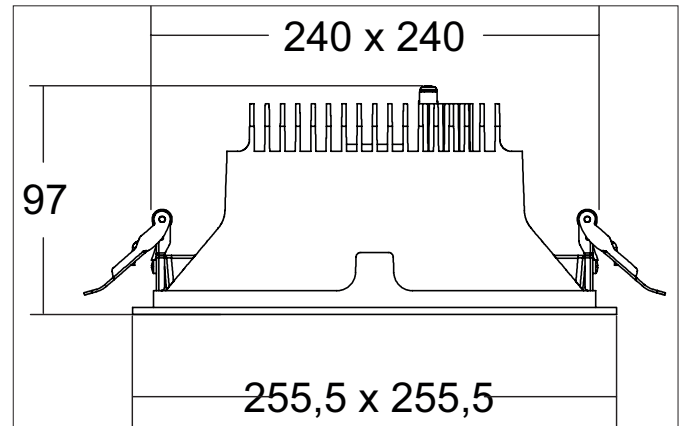

Tender

LED recessed downlight, square, DALI, Square. Toolless ceiling installation by installation springs. Ceiling cut-out L x W 240 x 240 mm, Installation depth 97 mm, Length 255 mm, Width 255 mm, Weight 0,85 kg, Reflector silver with rotationssymmetrical, deep, wide distributed light intensity. Cover plastic, transparent Luminous flux 3.194 lm, UGR < 19, Power 1 x 24,5 W, Light colour neutral white, Correlated color temperature (CCT) 4.000 K, Colour rendering index CRI > 90, Rated life time L80/B10 at 25 °C: 50.000 h, Rated life time L80/B50 at 25 °C: 50.000 h, Housing material: Aluminium / Glass / Plastic, Colour: white structure, Permissible ambient temperature (ta): -20 °C up to +25 °C, Protection class (EN 61140): II, Degree of protection (DIN EN 60529): IP20. With electronic driver, DALI-2 dimmable.

APOLLO MEGA LED recessed downlight, square, DALI

Article no. 41645174DA

Article data	
Article no.	41645174DA
GTIN	4251433991083
Series name	APOLLO MEGA
Short description	LED recessed downlight, square, DALI
Material	Aluminium / Glass / Plastic
Colour	white structure
Type of surface	Structure
Shape	Square
Length	255 mm
Width	255 mm
Built-in length	240 mm
Built-in width	240 mm
Installation depth	97 mm
Weight	0.85 kg
D licence plate	No
Conformance	CE, UKCA

Lighting technology	
Colour temperature	4.000 K
Light colour	white
Light output	Direct
Luminous flux	3,194 lm
System efficiency	130 lm/W
Colour rendering	CRI > 90
Reflector	Faceted
Reflector colour	silver
Beam angle	55°
Glare evaluation	UGR < 19
Light sharing	Symmetric
Adjustable color temperature	No

Operating technology of the luminaire	
System output	24.5 W
Voltage type	AC
AC nominal voltage max	230 V
Frequency max	50 Hz
Lamp	LED
Lamp holder	Without fitting
Protection class	II
Degree of protection	IP20
Control	DALI-2
Bulb change possible	The light source of this luminaire may only be replaced by the manufacturer or a service technician commissioned by him or a similarly qualified person.
Rated life time L80/B10 at 25 °C	50.000 h
Rated life time L80/B50 at 25 °C	50.000 h
Energy efficiency class	not required

Mounting technology	
Mounting method	Recessed mounting
Place of installation	Ceiling-mounted
Adjustability	Not adjustable
Further references	No cover with thermal insulation material
Material cover	Plastic, transparent
Suitable for through-wiring	No

**APOLLO MEGA LED recessed downlight, square, DALI**
Article no. 41645174DA

Packing data	
Gross weight	1.01 kg
Length of packaging	205 mm
Packaging width	205 mm
Packaging height	97 mm
Disposal at end of life	<p>This product must not be disposed of with household waste. You are obliged, to dispose of such electrical waste separately.</p> <p>By disposing of electrical waste and other old or defective electronics separately, you support recycling or other forms of re-use. In that way you help to take care and to avoid that harmful substances get into the environment.</p>