

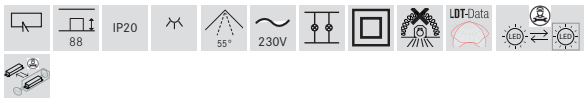

APOLLO MIDI LED downlight, square, on/off switchable
Article no. 41643185

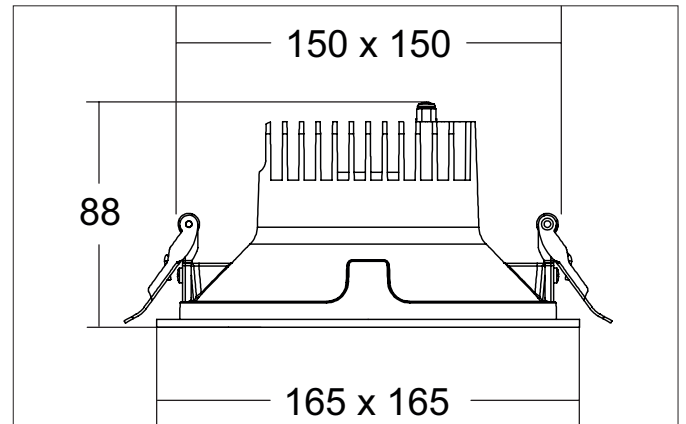

Tender

LED downlight, square, on/off switchable, Square. Toolless ceiling installation by installation springs. Ceiling cut-out L x W 150 x 150 mm, Installation depth 88 mm, Length 165 mm, Width 165 mm, Weight 0,55 kg, Reflector silver with rotationssymmetrical, deep, wide distributed light intensity. Cover plastic, transparent Luminous flux 1.915 lm, UGR < 19, Power 1 x 14,5 W, Light colour neutral white, Correlated color temperature (CCT) 3.500 K, Colour rendering index CRI > 90, Rated life time L80/B10 at 25 °C: 50.000 h, Rated life time L80/B50 at 25 °C: 50.000 h, Housing material: Aluminium / Glass / Plastic, Colour: black structure, Permissible ambient temperature (ta): -20 °C up to +25 °C, Protection class (EN 61140): II, Degree of protection (DIN EN 60529): IP20. With electronic driver, on/off switchable.

APOLLO MIDI LED downlight, square, on/off switchable

Article no. 41643185

Article data	
Article no.	41643185
GTIN	4251433990321
Series name	APOLLO MIDI
Short description	LED downlight, square, on/off switchable
Material	Aluminium / Glass / Plastic
Colour	black structure
Type of surface	Structure
Shape	Square
Length	165 mm
Width	165 mm
Built-in length	150 mm
Built-in width	150 mm
Installation depth	88 mm
Weight	0.55 kg
D licence plate	No
Conformance	CE, UKCA

Lighting technology	
Colour temperature	3.500 K
Light colour	white
Light output	Direct
Luminous flux	1,915 lm
System efficiency	132 lm/W
Colour rendering	CRI > 90
Reflector	Faceted
Reflector colour	silver
Beam angle	55°
Glare evaluation	UGR < 19
Light sharing	Symmetric
Adjustable color temperature	No

Operating technology of the luminaire	
System output	14.5 W
Voltage type	AC
AC nominal voltage max	230 V
Frequency max	50 Hz
Lamp	LED
Lamp holder	Without fitting
Protection class	II
Degree of protection	IP20
Control	on/off
Bulb change possible	The light source of this luminaire may only be replaced by the manufacturer or a service technician commissioned by him or a similarly qualified person.
Rated life time L80/B10 at 25 °C	50.000 h
Rated life time L80/B50 at 25 °C	50.000 h
Energy efficiency class	not required

Mounting technology	
Mounting method	Recessed mounting
Place of installation	Ceiling-mounted
Adjustability	Not adjustable
Further references	No cover with thermal insulation material
Material cover	Plastic, transparent
Suitable for through-wiring	No

**APOLLO MIDI LED downlight, square, on/off switchable**
Article no. 41643185

Packing data	
Gross weight	0.61 kg
Length of packaging	165 mm
Packaging width	165 mm
Packaging height	87 mm
Disposal at end of life	<p>This product must not be disposed of with household waste. You are obliged, to dispose of such electrical waste separately.</p> <p>By disposing of electrical waste and other old or defective electronics separately, you support recycling or other forms of re-use. In that way you help to take care and to avoid that harmful substances get into the environment.</p>