

APOLLO MINI LED downlight, reflector faceted, on/off
Article no. 43642175

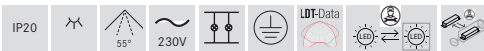
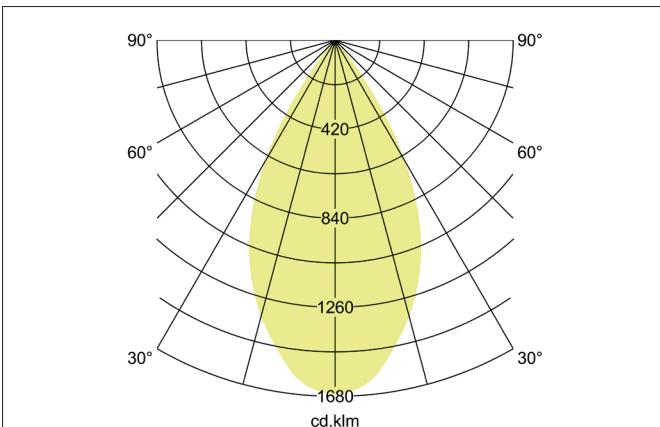
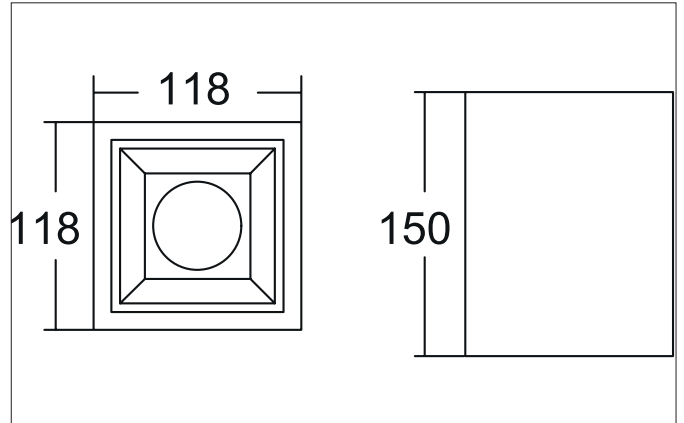

Tender
LED downlight, reflector faceted, on/off, Square. Luminaire length 117.5 mm, Luminaire width 118.0 mm, Height 150.0 mm Weight 0.939 kg, Reflector silver with rotationssymmetrical, deep, wide distributed light intensity. Cover plastic, transparent Luminous flux 1.391 lm, UGR < 19, Power 1 x 10,5 W, Light colour neutral white, Correlated color temperature (CCT) 3.500 K, Colour rendering index CRI > 90, Rated life time L80/B10 at 25 °C: 50.000 h, Housing material: Aluminium / Glass / Plastic, Colour: white structure, Permissible ambient temperature (ta): -20 °C up to +25 °C, Protection class (EN 61140): I, Degree of protection (DIN EN 60529): IP20. With electronic driver, on/off switchable.

Article data	
Article no.	43642175
GTIN	4255752506447
Series name	APOLLO MINI
Short description	LED downlight, reflector faceted, on/off
Material	Aluminium / Glass / Plastic
Colour	white structure
Type of surface	Structure
Shape	Square
Length	117.5 mm
Width	118 mm
Height	150 mm
Weight	0.939 kg
D licence plate	No
Conformance	CE, UKCA

**APOLLO MINI LED downlight, reflector faceted, on/off**

Article no. 43642175

Lighting technology	
Colour temperature	3.500 K
Light colour	white
Light output	Direct
Luminous flux	1,391 lm
System efficiency	132 lm/W
McAdam-Step	McAdam-Step 3
Colour rendering	CRI > 90
Reflector	Faceted
Reflector colour	silver
Beam angle	55°
Glare evaluation	UGR < 19
Light sharing	Symmetric
Adjustable color temperature	No

Operating technology of the luminaire	
System output	10.5 W
Voltage type	AC
AC nominal voltage max	230 V
Frequency max	50 Hz
Lamp	LED
Lamp holder	LED
Protection class	I
Degree of protection	IP20
Control	on/off
Bulb change possible	The light source of this luminaire may only be replaced by the manufacturer or a service technician commissioned by him or a similarly qualified person.
Rated life time L80/B10 at 25 °C	50.000 h
Energy efficiency class	not required

Mounting technology	
Mounting method	Surface mounting
Place of installation	Ceiling-mounted
Adjustability	Not adjustable
Material cover	Plastic, transparent
Suitable for through-wiring	No

Packing data	
Gross weight	1.114 kg
Length of packaging	175 mm
Packaging width	175 mm
Packaging height	155 mm
Disposal at end of life	This product must not be disposed of with household waste. You are obliged, to dispose of such electrical waste separately. By disposing of electrical waste and other old or defective electronics separately, you support recycling or other forms of re-use. In that way you help to take care and to avoid that harmful substances get into the environment.