

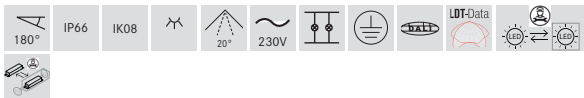

LAVILO I MINI LED Wallwasher, IP66
 Article no. 60842644

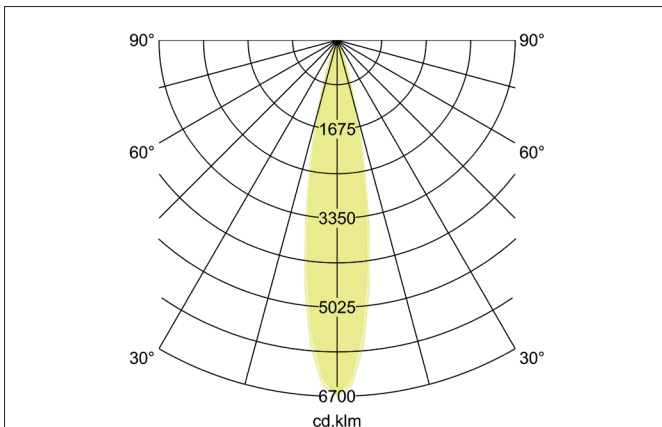
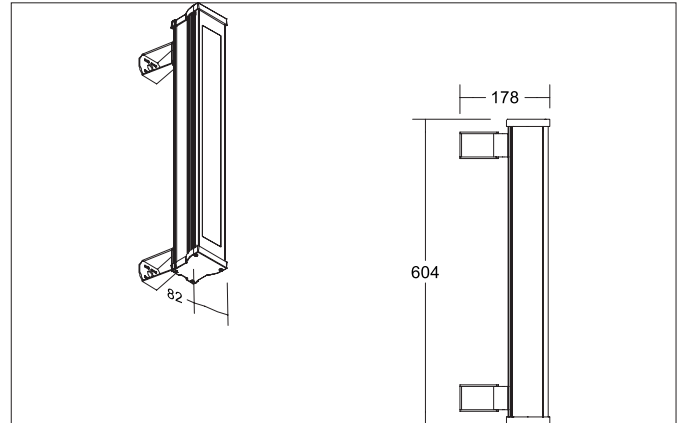

Tender
 LED Wallwasher, IP66, Rectangular. Luminaire length 604.0 mm, Luminaire width 82.0 mm, Hight 86.0 mm Weight 3.2 kg, with rotations-symmetrical, deep, wide distributed light intensity. Cover glass transparent. Luminous flux 2.890 lm, Power 22 W, Light colour neutral white, Correlated color temprature (CCT) 4.000 K, Colour rendering index CRI > 80, Housing material: Aluminium / Glass, Colour: titanium matt, Permissible ambient temperature (ta): -25 to +50°, Protection class (EN 61140): I, Degree of protection (DIN EN 60529): IP66, shock resistance according to IEC62262: IK08 .With electronic driver, DALI-DT6 dimmable.

Article data	
Article no.	60842644
GTIN	4251433993773
Series name	LAVILO I MINI
Short description	LED Wallwasher, IP66
Material	Aluminium / Glass
Colour	titanium matt
Type of surface	Matt
Shape	Rectangular
Length	604 mm
Width	82 mm
Hight	86 mm
Scope of delivery	incl. converter for connection to 230 V mains voltage, DALI.
Weight	3.2 kg
Conformance	CE, UKCA

LAVILO I MINI LED Wallwasher, IP66

Article no. 60842644

Lighting technology	
Colour temperature	4.000 K
Light colour	white
Light output	Direct
Luminous flux	2,890 lm
System efficiency	131 lm/W
McAdam-Step	McAdam-Step 5
Colour rendering	CRI > 80
Luminaire optics	Lens
Beam angle	20°
Light sharing	Symmetric
Adjustable color temperature	No

Operating technology of the luminaire	
System output	22 W
Voltage type	AC
AC nominal voltage max	230 V
Frequency max	50 Hz
Frequency min	50 Hz
Lamp	LED
Lamp holder	Without fitting
Protection class	I
Degree of protection	IP66
Ambient temperature	-25 to +50°
Control	DALI-DT6
Design of the connecting cable	side connection cable
Bulb change possible	The light source of this luminaire may only be replaced by the manufacturer or a service technician commissioned by him or a similarly qualified person.
Rated life time L90/B10 at 25 °C	50.000 h
Energy efficiency class	not required

Mounting technology	
Mounting method	Surface mounting
Place of installation	Wall-mounted
Adjustability	Pivoted
Swivel angle	180°
Impact resistance	IK08
Material cover	Glass transparent
Suitable for through-wiring	No

Packing data	
Gross weight	3.7 kg
Length of packaging	654 mm
Packaging width	140 mm
Packaging height	140 mm
Disposal at end of life	This product must not be disposed of with household waste. You are obliged, to dispose of such electrical waste separately. By disposing of electrical waste and other old or defective electronics separately, you support recycling or other forms of re-use. In that way you help to take care and to avoid that harmful substances get into the environment.