







# Mini-Verteiler / Mini Distributor

MPD12-HS K Cat.6<sub>A</sub> / MPD12-H K Cat.6<sub>A</sub> / MPD8 - HS K Cat.6<sub>A</sub>  
 MPD6-HS K Cat.6<sub>A</sub> / MPD6-H K Cat.6<sub>A</sub> / MPD8 AMJ/UMJ TH35/AP Cat.6<sub>A</sub>





## Montageanleitung / Assembly Instructions

<p><b>1</b> Lieferumfang / scope of delivery                  geschirmt/shielded, LSA ungeschirmt / unshielded                  J02022A0052 alpinweiß / alpine white J02022A0054 lichtgrau / light grey                  J02022A0053 lichtgrau / light grey</p> 	<p><b>2</b></p>  <p>drücken / press</p> <p>41,5 mm</p> <p>236 mm</p> <p>Befestigungsspur // fixing rail</p>
<p><b>3</b> Lieferumfang / scope of delivery                  geschirmt / shielded, LSA                  J02021A0030 alpinweiß / alpine white</p> 	<p><b>4</b></p>  <p>drücken / press</p> <p>150 mm</p> <p>Befestigungsspur // fixing rail</p>
<p><b>5</b> Lieferumfang / scope of delivery                  geschirmt / shielded, LSA ungeschirmt / unshielded                  J02022A0050 alpinweiß / alpine white J02022A0053 lichtgrau / light grey                  J02022A0051 lichtgrau / light grey</p> 	<p><b>6</b> Lieferumfang / scope of delivery                  Modular                  H02000A0103 alpinweiß / alpine white</p> 

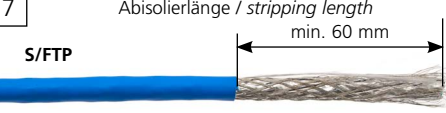
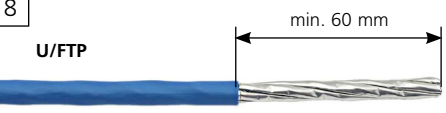

### Hinweis für Montage und Benutzung / Note for Installation and Use

Anschlussdosen und Patch Panels entsprechen den Normen / Outlets and Patch Panels meet the specifications EN 50173-1, IEC 60603-7-51 und / and IEC 60603-7-41.

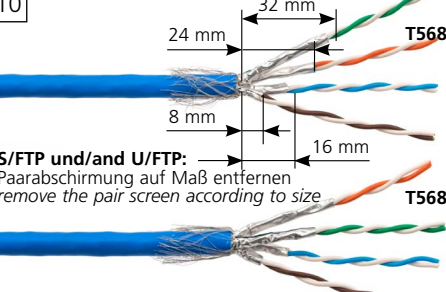
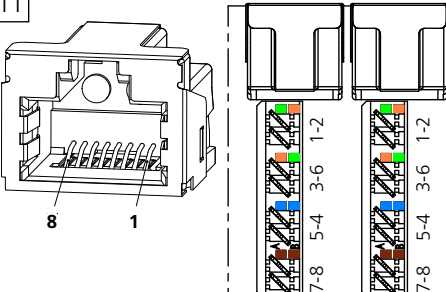
<p><b>7</b> Abisolierlänge / stripping length                  min. 60 mm</p> <p>S/FTP</p>  <p>Geflechtschirm nach hinten legen                  fold braided shield backwards</p> <p>20 mm</p> <p>Adernpaare vorsortieren / presort pairs                  Paarabschirmung nicht entfernen                  do not remove the pair screen</p>	<p><b>8</b> min. 60 mm</p> <p>U/FTP</p>  <p>Beilauferdraht gewickelt / drain wire wrapped</p>	<p><b>9</b> Isolierkreuz abschneiden                  cut off cross separator</p> <p>U/UTP</p>  <p>min. 60 mm</p> <p>Verdrillung der Adernpaare nicht auflösen / do not untwist the pairs</p>																																																																						
<p><b>10</b> 32 mm, 24 mm, 8 mm, 16 mm</p> <p>S/FTP und/and U/FTP:                  Paarabschirmung auf Maß entfernen                  remove the pair screen according to size</p> <p>T568A, T568B</p> 	<p><b>11</b></p>  <p>8, 1</p>	<p><b>12</b> Anschluss Connection</p> <table border="1"> <thead> <tr> <th colspan="2">Farbcode Colour code T568</th> <th>RJ45 PIN Nr./No.</th> <th>10BT/100BT</th> <th>1 Gigabit/10 Gigabit Ethernet</th> <th>Token Ring ISDN/So</th> <th>Upo/TEL</th> </tr> <tr> <th>A</th> <th>B</th> <th></th> <th></th> <th></th> <th></th> <th></th> </tr> </thead> <tbody> <tr> <td>W - G</td> <td>W - O</td> <td>1</td> <td>•</td> <td>•</td> <td></td> <td></td> </tr> <tr> <td>G</td> <td>O</td> <td>2</td> <td>•</td> <td>•</td> <td></td> <td></td> </tr> <tr> <td>W - O</td> <td>W - G</td> <td>3</td> <td>•</td> <td>•</td> <td></td> <td></td> </tr> <tr> <td>BL</td> <td>BL</td> <td>4</td> <td></td> <td></td> <td>•</td> <td>•</td> </tr> <tr> <td>W - BL</td> <td>W - BL</td> <td>5</td> <td></td> <td></td> <td>•</td> <td>•</td> </tr> <tr> <td>O</td> <td>G</td> <td>6</td> <td>•</td> <td>•</td> <td></td> <td></td> </tr> <tr> <td>W - BR</td> <td>W - BR</td> <td>7</td> <td></td> <td></td> <td>•</td> <td></td> </tr> <tr> <td>BR</td> <td>BR</td> <td>8</td> <td></td> <td></td> <td>•</td> <td></td> </tr> </tbody> </table> <p>Anwendung / Application</p>	Farbcode Colour code T568		RJ45 PIN Nr./No.	10BT/100BT	1 Gigabit/10 Gigabit Ethernet	Token Ring ISDN/So	Upo/TEL	A	B						W - G	W - O	1	•	•			G	O	2	•	•			W - O	W - G	3	•	•			BL	BL	4			•	•	W - BL	W - BL	5			•	•	O	G	6	•	•			W - BR	W - BR	7			•		BR	BR	8			•	
Farbcode Colour code T568		RJ45 PIN Nr./No.	10BT/100BT	1 Gigabit/10 Gigabit Ethernet	Token Ring ISDN/So	Upo/TEL																																																																		
A	B																																																																							
W - G	W - O	1	•	•																																																																				
G	O	2	•	•																																																																				
W - O	W - G	3	•	•																																																																				
BL	BL	4			•	•																																																																		
W - BL	W - BL	5			•	•																																																																		
O	G	6	•	•																																																																				
W - BR	W - BR	7			•																																																																			
BR	BR	8			•																																																																			

• Druckfehler und technische Änderungen vorbehalten / Errors and technical changes accepted

D B05030A0417 8.09.2015 © by Telegärtner

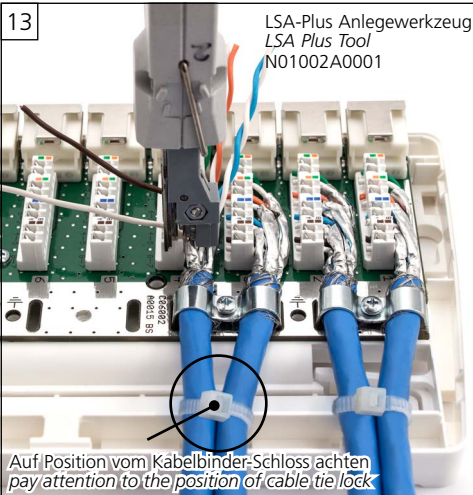

Auf Position vom Kabelbinder-Schloss achten  
pay attention to the position of cable tie lock

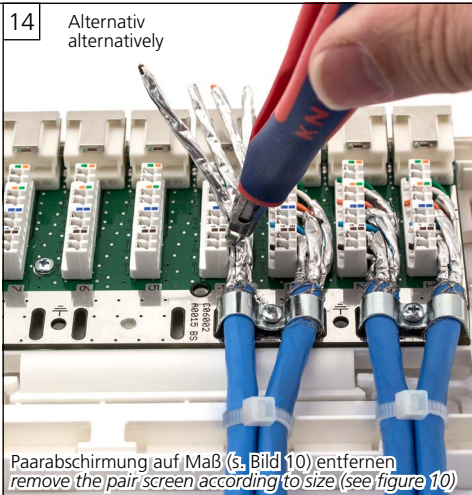

Alternativ  
alternatively  
Paarabschirmung auf Maß (s. Bild 10) entfernen  
remove the pair screen according to size (see figure 10)

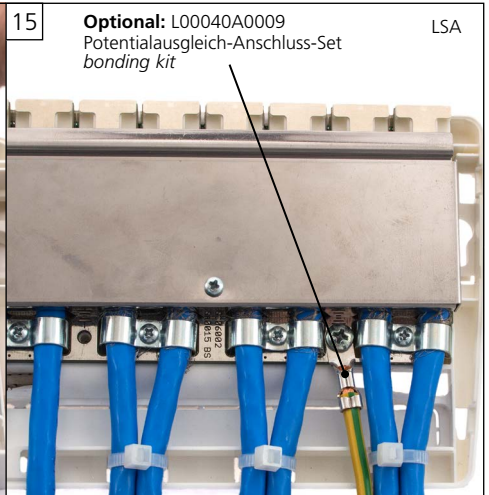

Optional: L00040A0009  
Potentialausgleich-Anschluss-Set  
bonding kit

LSA

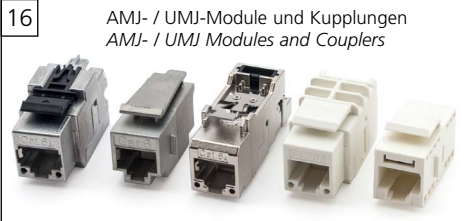

AMJ- / UMJ-Module und Kupplungen  
AMJ- / UMJ Modules and Couplers



18 Modul oben in den Modulträger einhaken und unten einrasten / engage module in bezel and push it downwards until it snap; secure it into place

Einbau des Moduls  
installing the modules

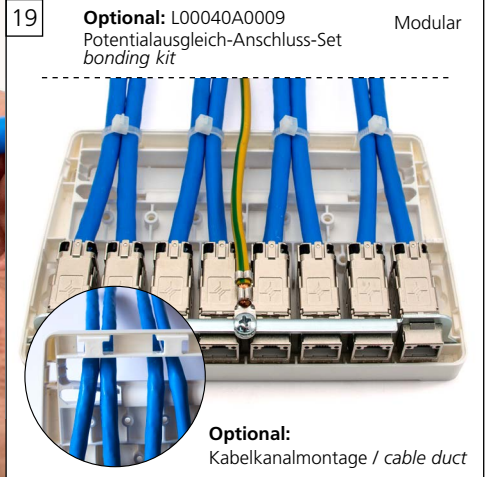

Optional: L00040A0009  
Potentialausgleich-Anschluss-Set  
bonding kit

Modular

Optional:  
Kabelkanalmontage / cable duct

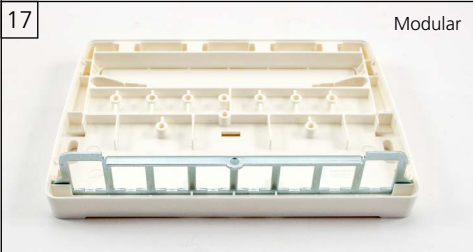

Modular

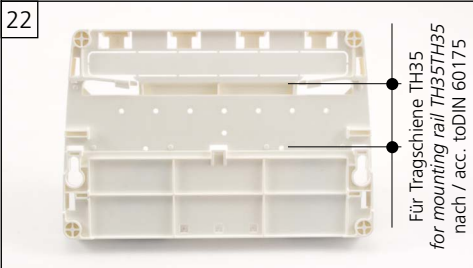
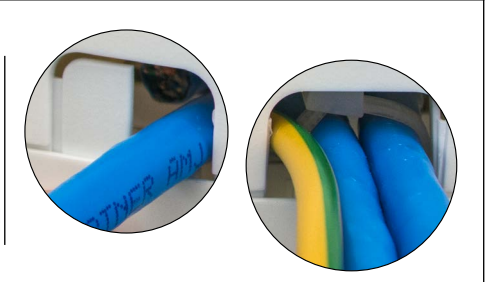
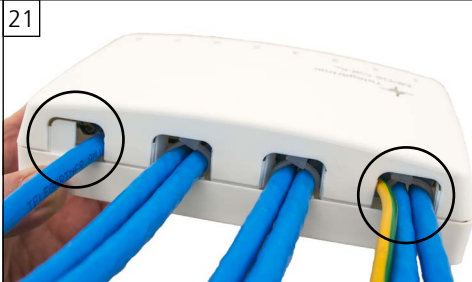

Für Tragschiene TH35  
for mounting rail TH35/TH35  
nach / acc. to DIN 60175

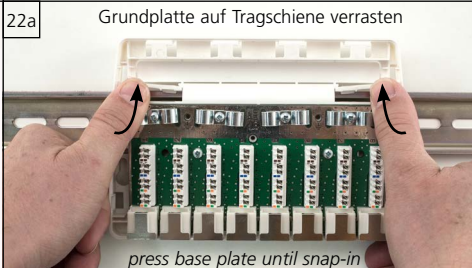

Grundplatte auf Tragschiene verrasten

press base plate until snap-in

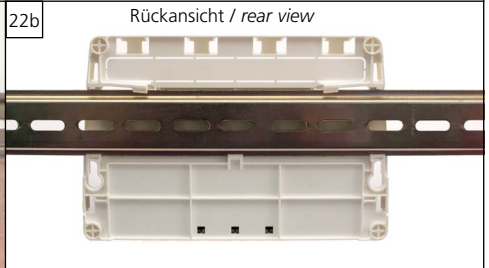

Rückansicht / rear view

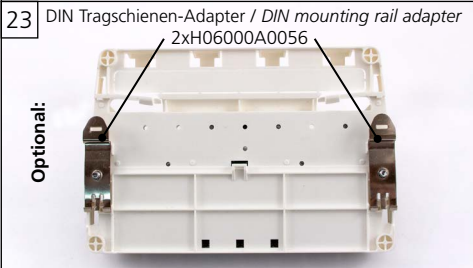

Optional:  
DIN Tragschienen-Adapter / DIN mounting rail adapter  
2xH06000A0056



Grundplatte mit Tragschienen-Adapter  
auf Tragschiene verrasten

snap base plate and adapter onto DIN mounting rail

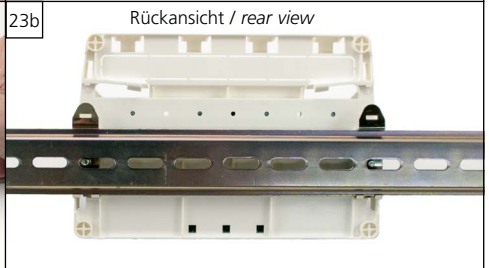

Rückansicht / rear view

Demontage / Disassembly

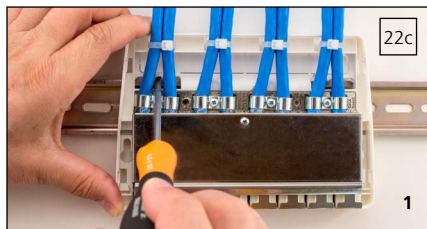

22c

1

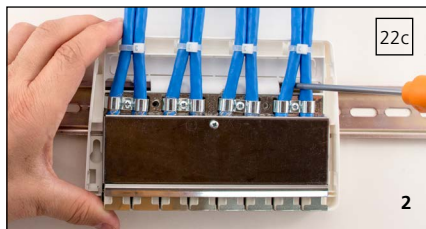

22c

2

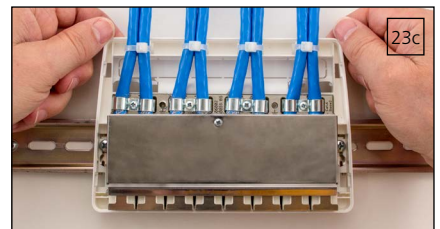

23c