

# TOC RJ45 plug set IP68 und/and TOC RJ45 coupler IP68

## Montagehinweis / Mounting information

70  
50  
15  
10  
5  
mm

**1** Lieferumfang / Scope of delivery  
**TOC plug set IP68 MFP8 T568B Cat.6A**

J60026A0000  
Messing / Brass

J60026A0001  
Edelstahl / Stainless steel

für Kabel  
for cable  
Ø4,0-6,5 mm

für Kabel  
for cable  
Ø6,5-9,5 mm

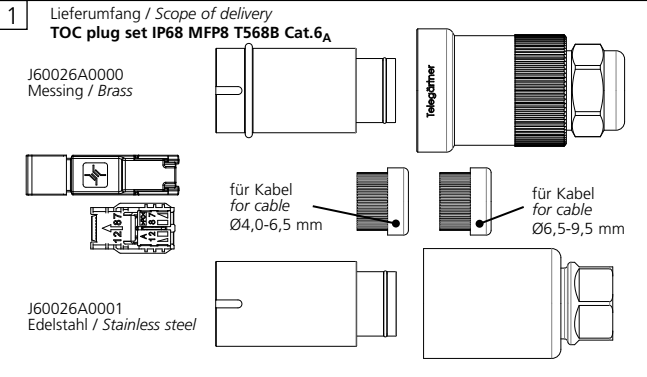

**1a** **Optional**

H60030A0001  
Messing / Brass

snap-on

H60030A0003  
Edelstahl / Stainless steel

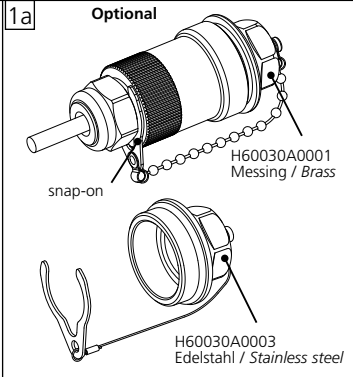

**2** Lieferumfang / Scope of delivery  
**TOC coupler IP68 AMJ Coupler K Cat.6**

J60029A0000  
Messing / Brass

J60029A0001  
Edelstahl / Stainless steel

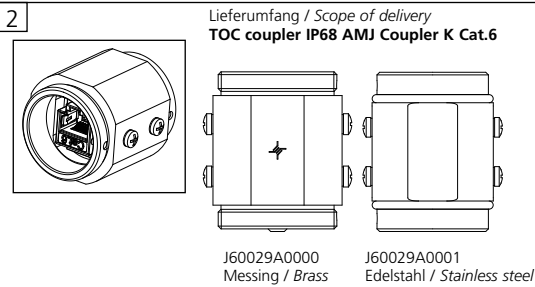

**2a** **Optional**

H60030A0000  
Messing / Brass

H60030A0002  
Edelstahl / Stainless steel

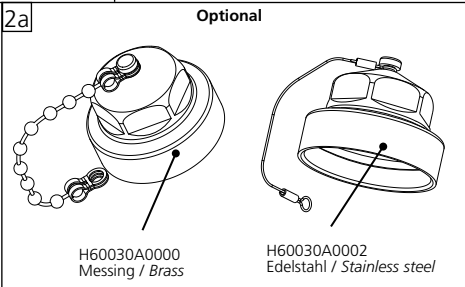

**3** Teile des Steckerkörpers zusammenfügen (1+2)

Steckerkörper (3) über das Kabel aufschieben, MFP8 Stecker (4) an Kabel gemäß Montagehinweis B05030A0365 anschließen

press plug housing parts together (1+2)

slide plug housing (3) over cable, connect MFP8 plug (4) to cable according to mounting information B05030A0365

click

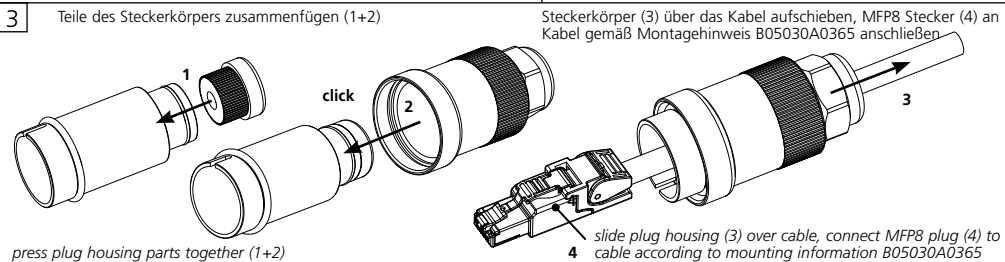

**4** MFP8 Stecker in RJ45-Buchse der Kupplung einrasten

press MFP8 plug into the RJ45 jack of coupler until snap-in

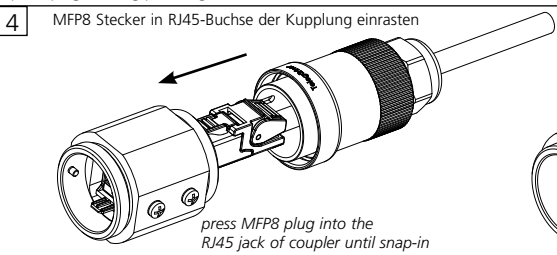

**5** Steckerkörper über den MFP8 Stecker auf die Kupplung schieben

slide plug housing over MFP8 plug onto coupler

auf Lage der Kodierung achten  
pay attention to the position of the coding

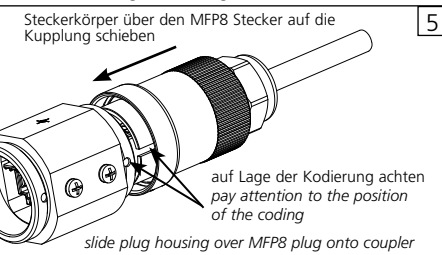

**6** Steckerkörper mit Gabelschlüssel (SW24) bis zum Anschlag auf die Kupplung festdrehen  
tighten plug body with spanner 24AF until stop

M3x6 (4x)

15mm

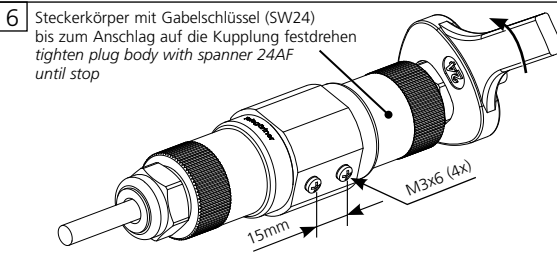

**7** Schutzkappen verschließen

close protective caps

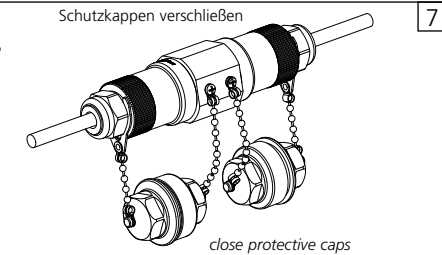

D B65030A0001a 14.09.2017 © by Telegärtner