

Klimatisierung

Kühlgeräte

Thermoelectric Cooler

SK 3201.200, SK 3201.300

Anbau

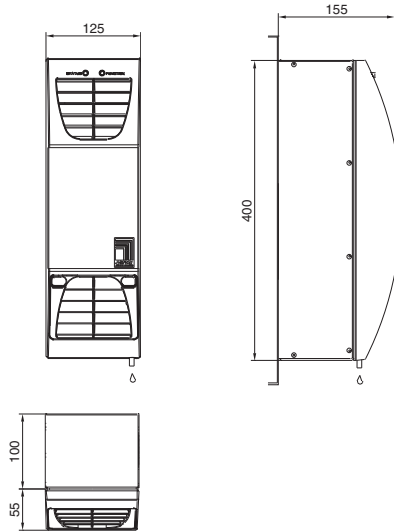

Einbau

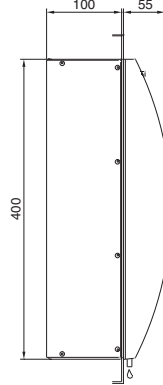

Montageausschnitt
Anbau

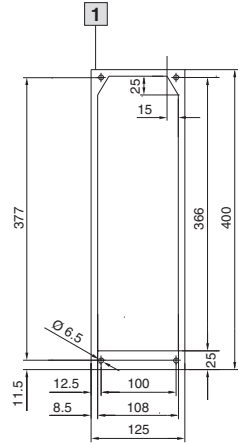

Montageausschnitt
Einbau

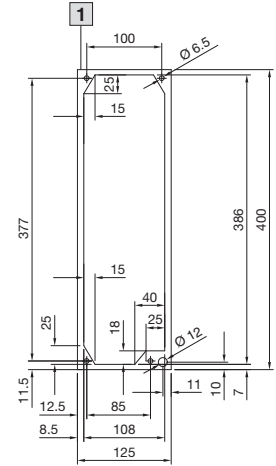

1 Außenkontur Klimagerät

Wandanbau-Kühlgeräte

TopTherm, Querformat, SK 3302.300, SK 3302.310

Anbau

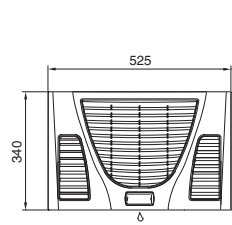

Einbau

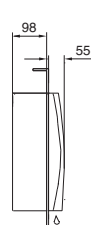

Montageausschnitt
Anbau

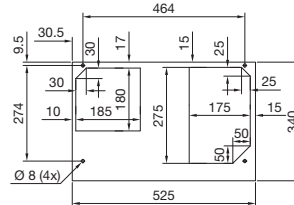

Montageausschnitt
Einbau

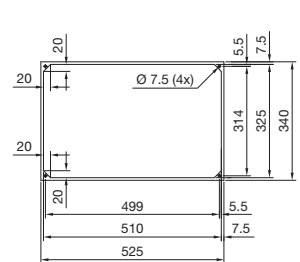

TopTherm, SK 3302.XXX

Anbau

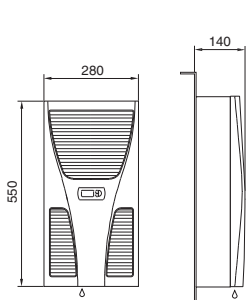

Einbau

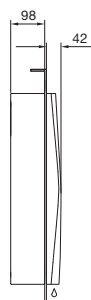

Montageausschnitt
Anbau

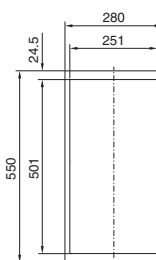

Montageausschnitt
Einbau

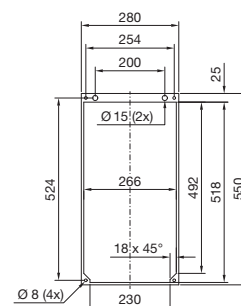

Wandanbau-Kühlgeräte

TopTherm Blue e, SK 3303.XXX, SK 3361.XXX

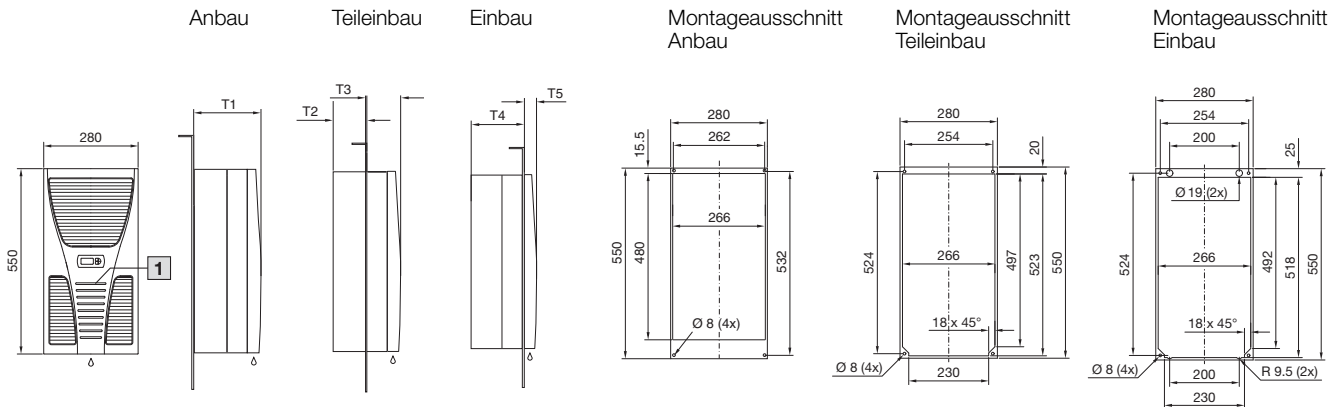

Best.-Nr. SK	Leistungs-klasse	T1	T2	T3	T4	T5
3303.XXX	500 W	206	100	106	164	42
3361.XXX	750 W	280	125	155	235	45

1 Nur bei 3361.XXX

TopTherm Blue e, SK 3304.XXX, SK 3305.XXX

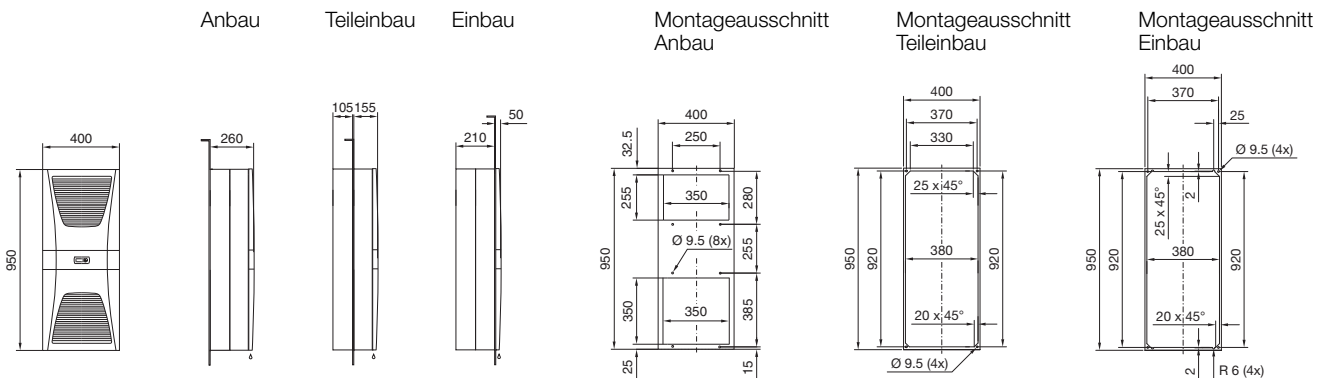

TopTherm Blue e, SK 3328.XXX, SK 3329.XXX

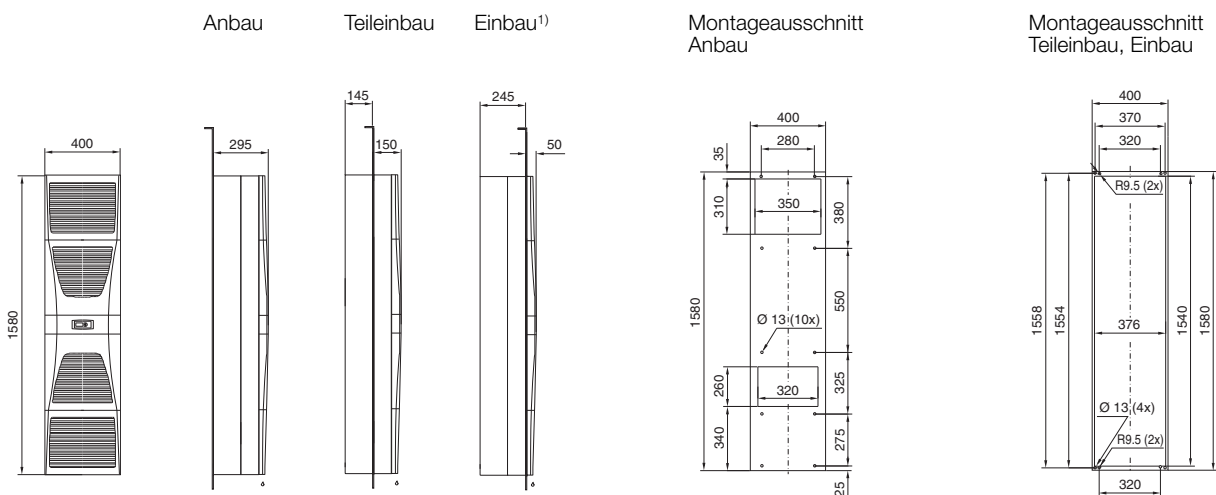

¹⁾ Bei Einbau in 600 mm breite Türen muss der Montageausschnitt um min. 10 mm aus der Türmitte in Richtung Scharnierseite versetzt werden

Klimatisierung

Kühlgeräte

Wandanbau-Kühlgeräte

TopTherm Blue e, SK 3332.XXX

Anbau

Teileinbau

Montageausschnitt
Anbau

Montageausschnitt
Teileinbau

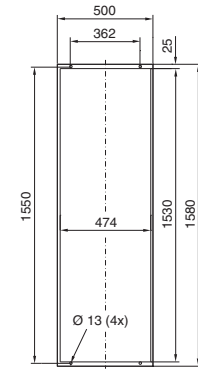
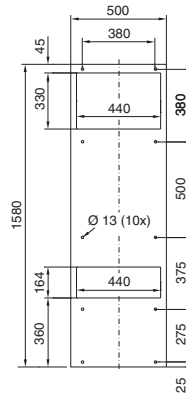
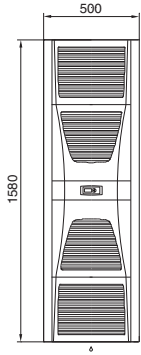

TopTherm Blue e, Flach, SK 3366.XXX

Anbau

Einbau

Montageausschnitt
Anbau

Montageausschnitt
Einbau

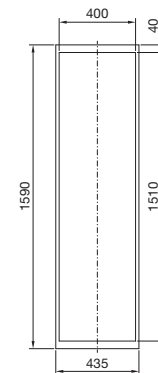
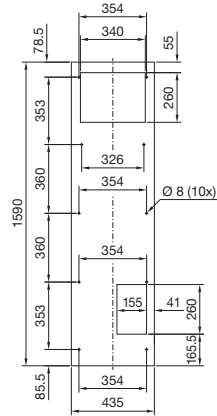
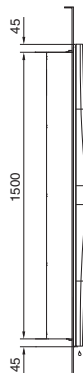
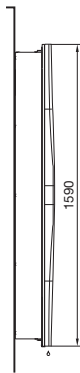
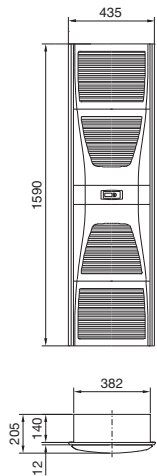

Wandanbau-Kühlgeräte

Blue e+, SK 3185.830, SK 3186.930, SK 3187.930, SK 3188.940, SK 3189.940

Übersicht der Montierbarkeit von Blue e+ Kühlgeräten an Schaltschränken

Montageart		1	Kein Standard				2	3	4	5	6	7	8	9	10	11	12	13	14
Breite mm	500	■	■	■	■	■	-	-	-	-	-	-	-	-	-	-	-	-	-
	600	-	-	-	-	-	■	■	■	■	■	-	-	-	-	-	-	-	-
	800	-	-	-	-	-	-	-	-	-	-	■	■	■	■	-	-	-	-
	1000 (2 x 500)	-	-	-	-	-	-	-	-	-	-	-	-	-	-	■	■	-	-
	1200 (2 x 600)	-	-	-	-	-	-	-	-	-	-	-	-	-	-	-	-	■	■
Türvariante	Schlosstür	-	-	-	-	-	-	-	-	-	-	-	-	-	-	■	-	■	-
	Anschlagtür	-	-	-	-	-	-	-	-	-	-	-	-	-	-	-	■	-	■
	Einzeltür	-	■	■	■	■	■	■	■	■	-	■	■	■	■	-	-	-	-
	Seitenwand	■	-	-	-	-	-	-	-	-	■	-	-	-	-	-	-	-	-
Verschluss-Systeme	Standard (Doppelbart)	-	-	■	-	■	-	■	-	■	-	-	■	-	■	-	-	-	-
	Komfortgriff	-	■	-	■	-	■	-	■	-	-	-	■	-	■	-	■	-	-
Scharnier	130°	-	-	-	■	■	-	-	■	■	-	-	■	■	■	■	■	■	■
	180°	-	■	■	-	-	■	■	-	-	■	■	-	-	-	-	-	-	-
Anbauart	Anbau	■	■	■	■	■	■	■	■	■	■	■	■	■	■	■	■	■	■
	Teileinbau	■	■	■	■	■	■	■	■	■	■	■	■	■	■	-	■ ¹⁾	■	■
	Volleinbau ¹⁾ (2 und 2,6 kW)	■	-	-	-	-	■ ¹⁾	■ ¹⁾	■ ¹⁾	■ ¹⁾	■	■	■	■	■	-	■ ¹⁾	■ ¹⁾	■

¹⁾ Ausbruch um 20 mm in Richtung Türanschlag verschieben

Blue e+, SK 3185.830

Einbaumöglichkeiten SK 3185.830

Anbau

Teileinbau

Einbau

Montageausschnitt Anbau, Teileinbau, Einbau

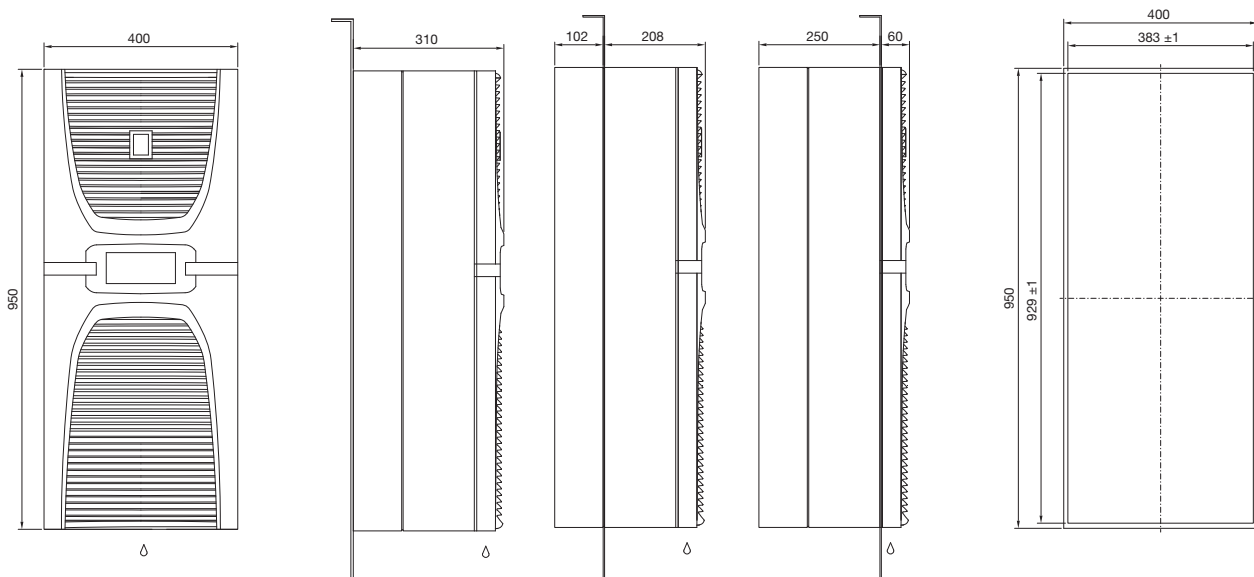

Klimatisierung

Kühlgeräte

Wandanbau-Kühlgeräte

Blue e+ SK 3186.930, SK 3187.930, SK 3188.940, SK 3189.940

Einbaumöglichkeiten SK 3186.930, SK 3187.930

Einbaumöglichkeiten SK 3188.940, SK 3189.940

Anbau

Teileinbau

Einbau

Anbau

Teileinbau

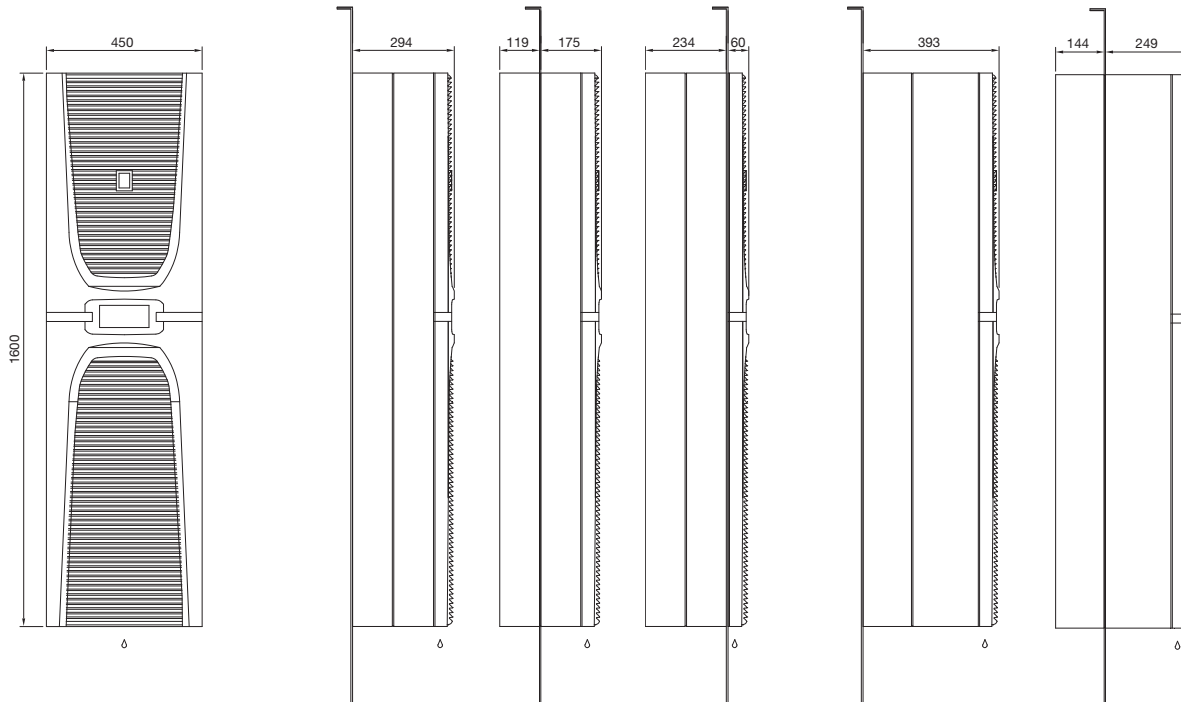

Montageausschnitt
Anbau, Teileinbau, Einbau für Tür,
Rück- und Seitenwand, B ≥ 600 mm

Montageausschnitt
Anbau für Rück- und Seitenwand,
B = 500 mm

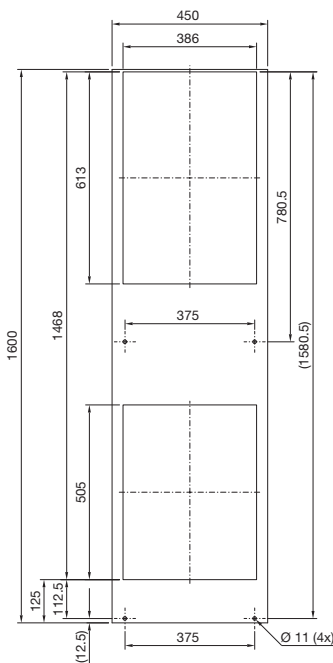
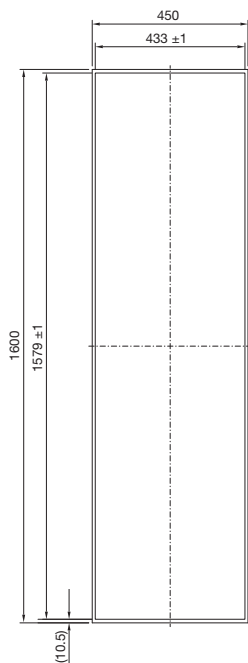

Wichtige Montagehinweise für Volleinbau

- Bei 4,2 und 5,8 kW grundsätzlich nicht möglich
- Für 600 mm breite Schranktüren gilt:
Ausbruch um 25 mm in Richtung Türanschlag verschieben und Türrohrrahmen demontieren

Wichtige Montagehinweise für den Anbau an 500 mm tiefe Schränke

- Teileinbau und Volleinbau nicht möglich
- Anbau nur möglich mit Montageausschnitt für 500 mm tiefe Schränke

Wandanbau-Kühlgeräte

TopTherm Blue e, Ausführung NEMA 4X, SK 3303.XXX

Anbau

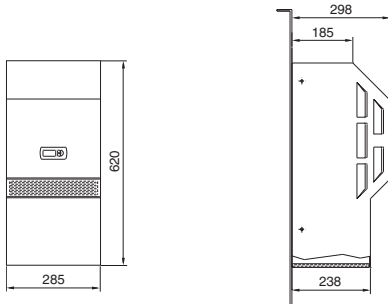

Montageausschnitt
Anbau

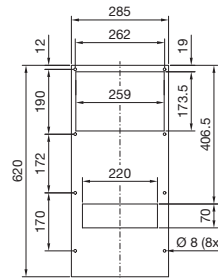

TopTherm Blue e, Ausführung NEMA 4X, SK 3304.XXX, SK 3305.XXX

Anbau

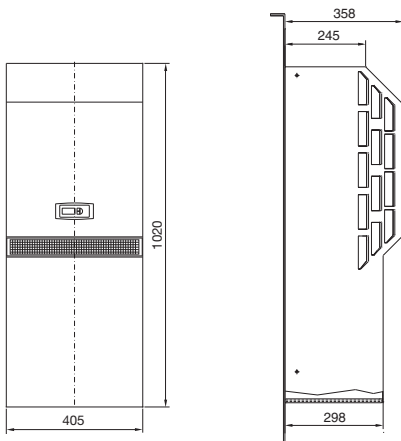

Montageausschnitt
Anbau

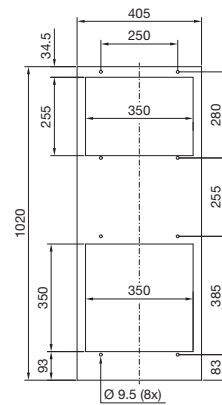

Klimatisierung

Kühlgeräte

Wandanbau-Kühlgeräte

TopTherm Blue e, Ausführung NEMA 4X, SK 3328.XXX, SK 3329.XXX

Anbau

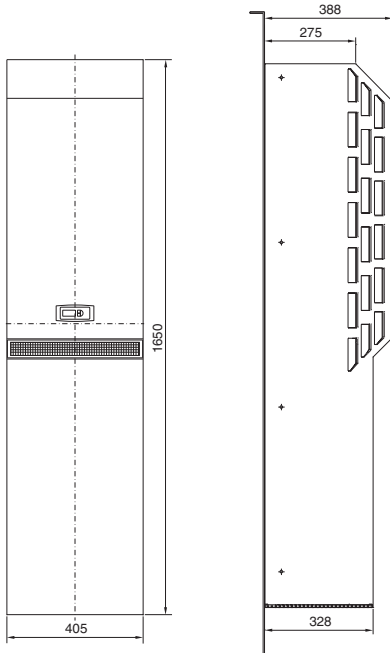

Montageausschnitt
Anbau

