



SV
3450.505
3455.505



IEC	0,5-6 mm ²	0,5-4 mm ²			0,5-1 mm ²
UL	AWG 20-10				
	Cu				
		10-12 mm			
Montage/Assembly					

SV 3450.505

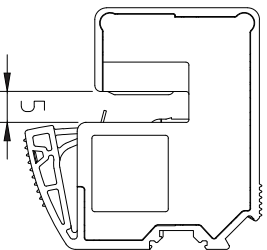

SV 3455.505

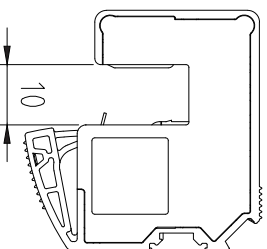

10 Leiteranschlussklemmen
 mit Push-In-Anschluss, 0,5 - 4 mm²

10 Conductor connection clamps
 with push-in connection, 0,5 - 4 mm²

10 Bornes pour raccordement de câbles
 avec raccordement push-in, 0,5 - 4 mm²

Zchng.-Nr. / No. of dwg. : A0881590/1SV

Lieferanten-Nr. / No. of supplier :

For further information: www.rittal.com

1a

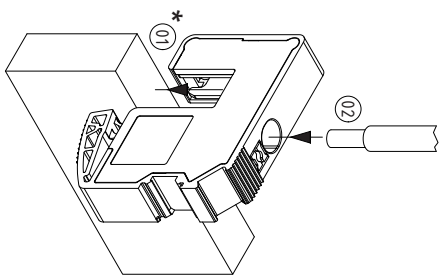

1b

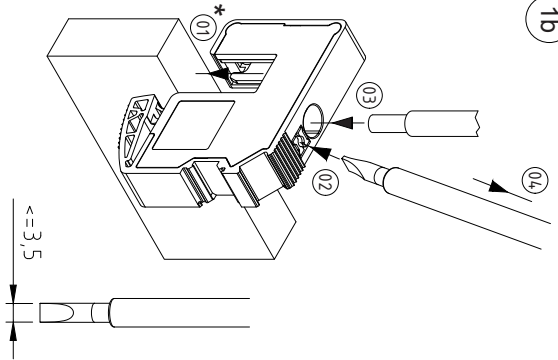

*

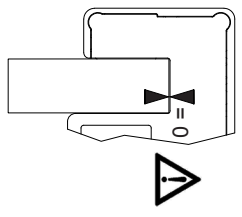

Hinweis / note / notice

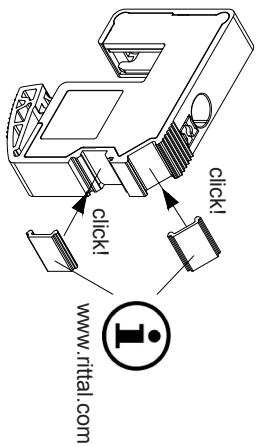

2

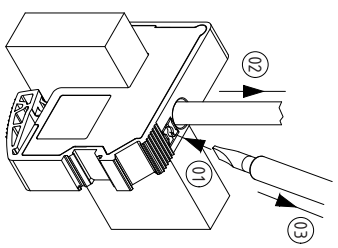

3a

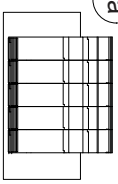

3b

