

# **Rittal – The System.**

**Faster – better – worldwide.**

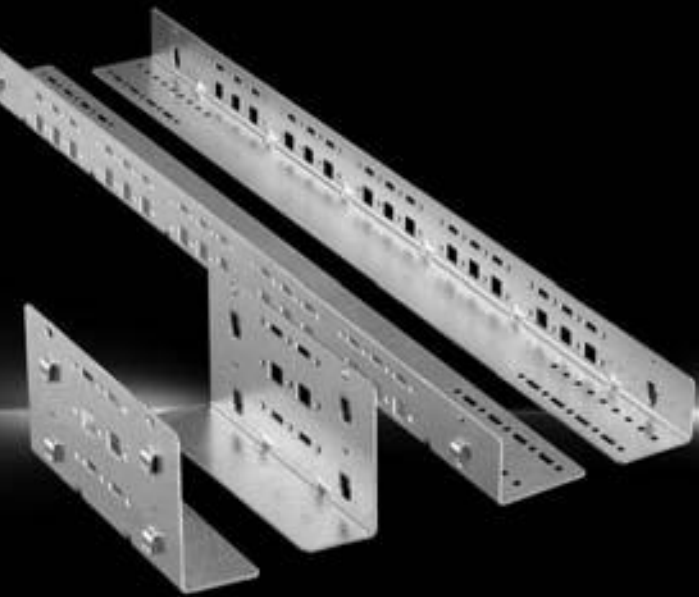

**Gleitschiene, Festeinbau**  
**Slide rail, static installation**  
**Glissière, fixe**  
**Glijrails**  
**Glidskena, statisk**  
**Guide di sostegno, installazione fissa**  
**Guía deslizante, montaje fijo**  
**サポートレール**

**DK 5501.400**

**DK 5501.410**

**DK 5501.420**

**DK 5501.430**









**DK 5501.440**

**DK 5501.450**

**Montage- und Bedienungsanleitung**  
**Assembly and operating instructions**  
**Notice d'emploi et de montage**  
**Montage- en bedieningshandleiding**  
**Montage- och bruksanvisning**  
**Istruzioni di montaggio**  
**Instrucciones de montaje**  
**取扱説明書**





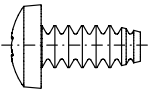

		X mm	D1 mm	 F [N]	
<b>Best.-Nr. TS</b> <b>Model No. TS</b> <b>Référence TS</b>	<b>A</b>	–	150	 300	<b>5501.400</b>
		345	275	 800	<b>5501.410</b>
		445	375	 800	<b>5501.420</b>
	<b>B</b>	545	475	 800	<b>5501.430</b>
		645	575	 800	<b>5501.440</b>
		745	675	 800	<b>5501.450</b>
	<b>A</b>				2 x
	<b>B</b>				2 x
				5,5 x 13	4 x

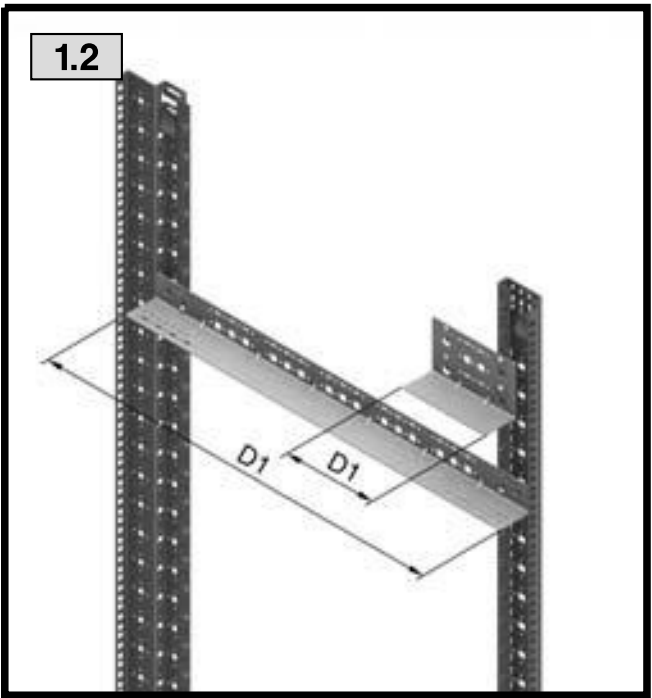
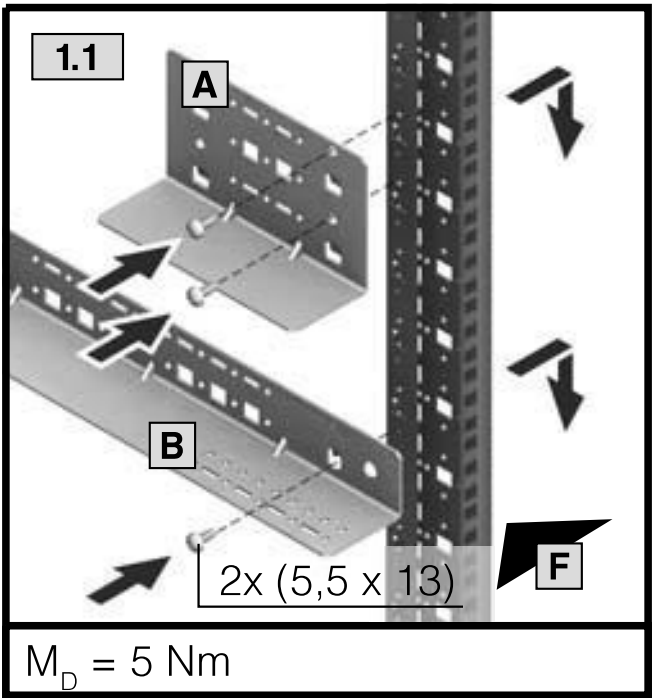
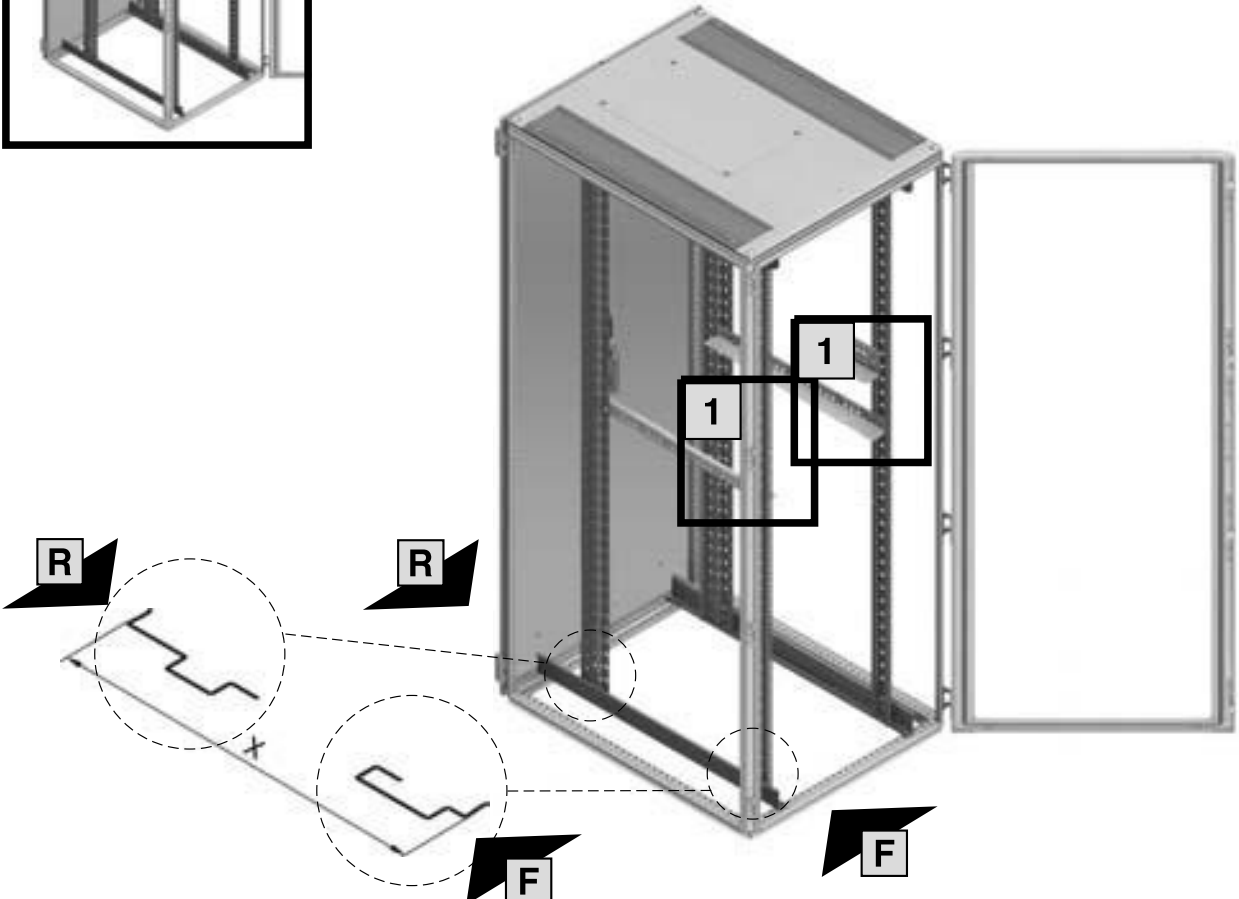

# TX25



# Rittal – The System.

---

**Faster – better – worldwide.**

- Enclosures
- Power distribution
- Climate control
- IT infrastructure
- Software & services

04.2012/A4638000IT73

RITTAL GmbH & Co. KG  
Postfach 1662 · D-35726 Herborn  
Phone + 49(0)2772 505-0 · Fax + 49(0)2772 505-2319  
E-Mail: [info@rittal.de](mailto:info@rittal.de) · [www.rittal.de](http://www.rittal.de)

