

### Ağ/sunucu kabinleri TS IT

Rack iklimlendirme sistemi için cam kapılı

Önden görünüş

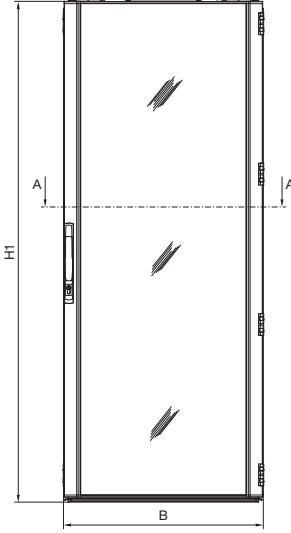

Kesit A – A, genişlik 800 mm

Yandan görünüş

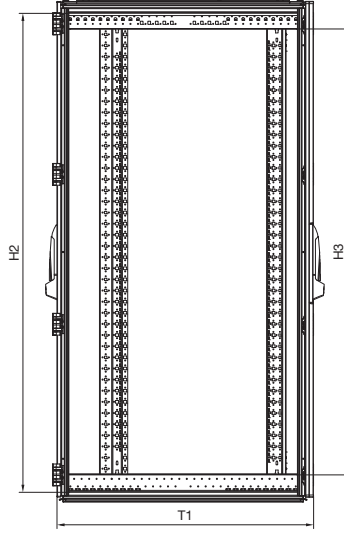

Kesit A – A, genişlik 600 mm

Arkadan görünüş

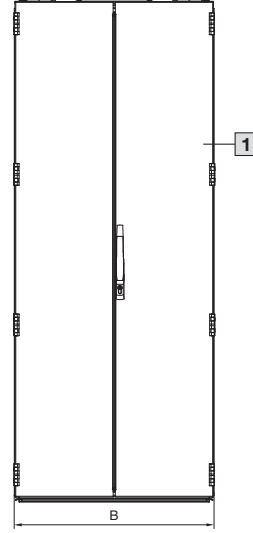

Üstten görünüş

Arkadan görünüş, IP 5

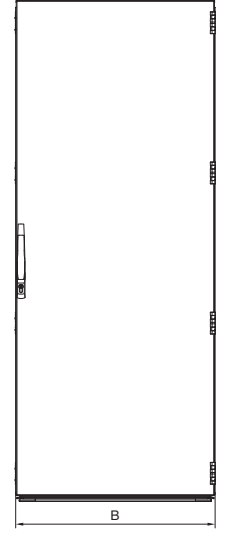

Üstten görünüş, IP 55

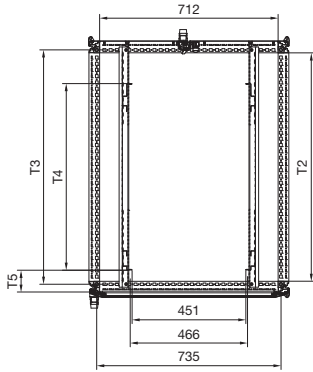

Kesit A – A, IP 55

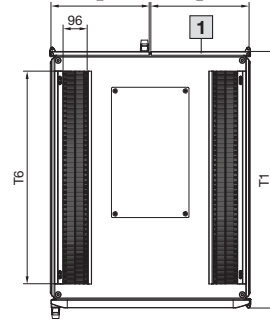
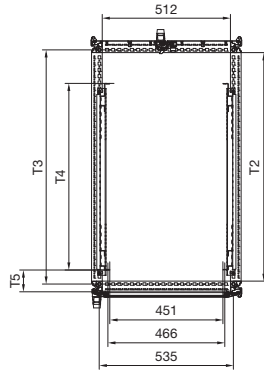

Üstten görünüş, derinlik 600 mm

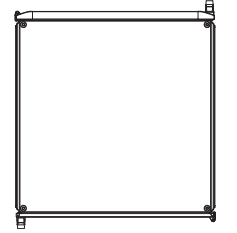

1 1200 mm yükseklik için tek parçalı kapı

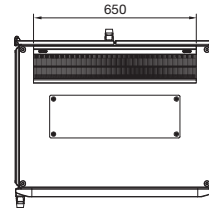
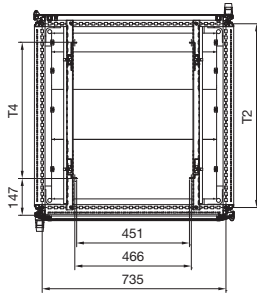

Model no. DK	IP 55	U	Genişlik ölçüleri mm			Yükseklik ölçüleri mm			Derinlik ölçüleri mm			
			B	H1	H2	H3	T1	T2	T3	T4	T5	T6
5503.120	-	24	797	1198,5	1112	974	824	712	735	545	147	650
5504.120	-	24	797	1198,5	1112	974	1024	912	935	745	87	850
5505.120	-	38	797	1798,5	1712	1574	824	712	735	545	147	650
5506.120	-	42	797	1998,5	1912	1774	624	512	535	445	87	650
5507.120	5507.130	42	797	1998,5	1912	1774	824	712	735	545	147	650
5508.120	-	42	597	1998,5	1912	1774	1024	912	935	745	87	850
5509.120	5509.130	42	797	1998,5	1912	1774	1024	912	935	745	87	850
5510.120	-	42	597	1998,5	1912	1774	1224	912	935	745	147	1050
5511.120	-	42	797	1998,5	1912	1774	1224	1112	1135	745	87	1050
5512.120	-	47	797	2198,5	2112	1974	824	712	735	545	147	650
-	5514.130	47	797	2198,5	2112	1974	1024	912	935	745	147	850

# Endüstriyel panolar

## IT kabin sistemleri

### Ağ/sunucu kabinleri TS IT

Rack iklimlendirme sistemi için cam kapılı, önceden konfigüre edilmiş

Önden görünüş

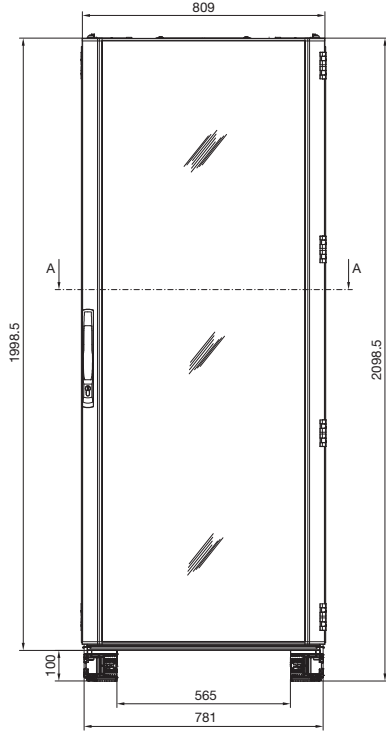

Yandan görünüş

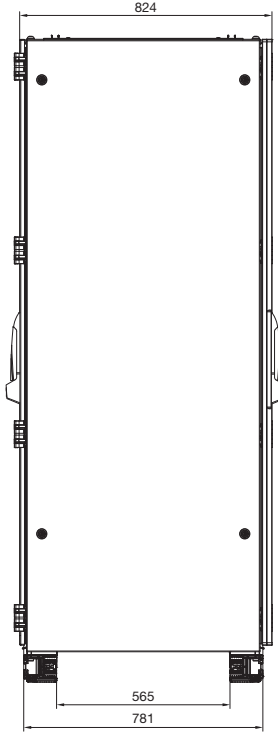

Arkadan görünüş

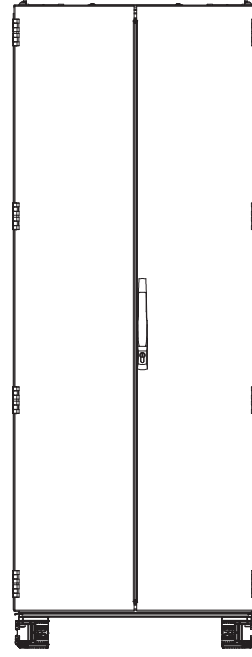

Kesit A – A

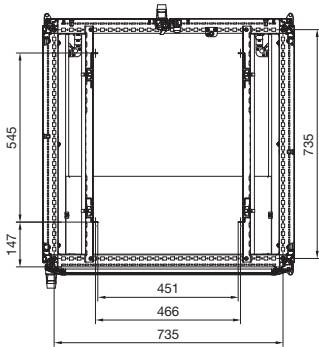

Üstten görünüş

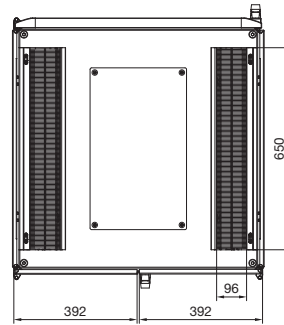

### Ağ/sunucu kabinleri TS IT

Ortam iklimlendirme sistemi için havalandırma kapılı

Önden görünüş

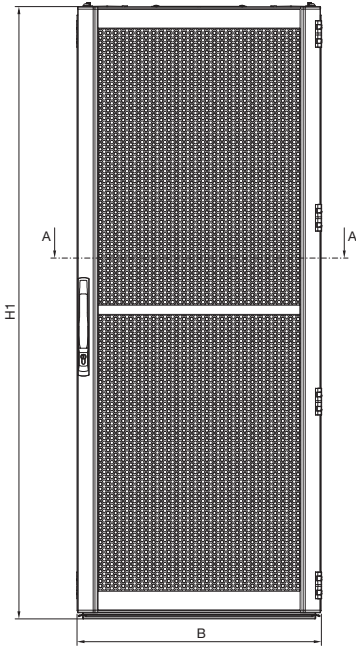

Yandan görünüş

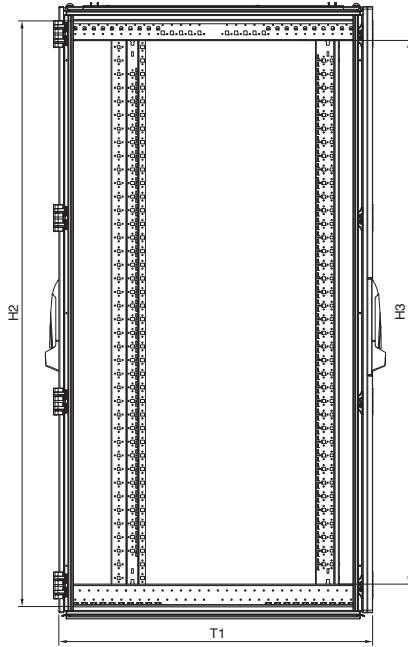

Arkadan görünüş

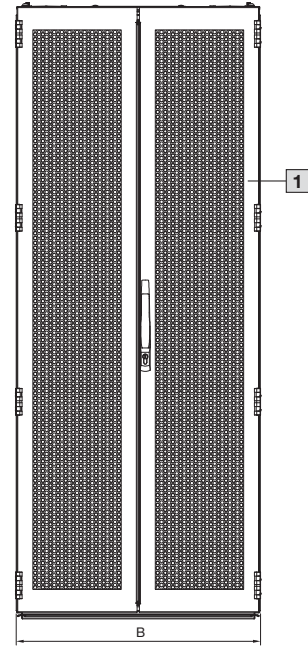

Kesit A – A  
genişlik 800 mm

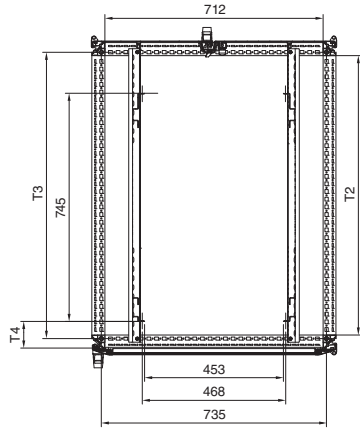

Kesit A – A  
genişlik 600 mm

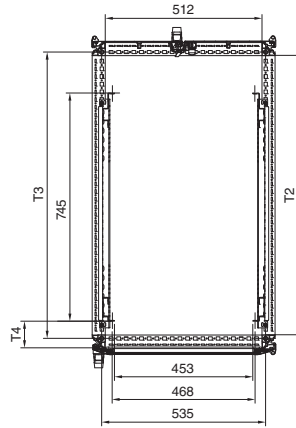

Üstten görünüş

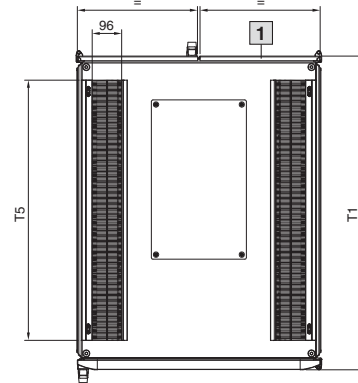

1 1200 mm yükseklik için tek parçalı kapı

Model no. DK	U	Genişlik ölçüleri mm		Yükseklik ölçüleri mm			Derinlik ölçüleri mm				
		B	H1	H2	H3	T1	T2	T3	T4	T5	
5504.110	24	797	1198,5	1112	974	1024	912	935	87	850	
5508.110	42	597	1998,5	1912	1774	1024	912	935	87	850	
5509.110	42	797	1998,5	1912	1774	1024	912	935	87	850	
5510.110	42	597	1998,5	1912	1774	1224	1112	1135	147	1050	
5511.110	42	797	1998,5	1912	1774	1224	1112	1135	147	1050	
5513.110	47	597	2198,5	2112	1974	1024	912	935	87	850	
5514.110	47	797	2198,5	2112	1974	1024	912	935	87	850	
5515.110	47	597	2198,5	2112	1974	1224	1112	1135	147	1050	
5516.110	47	797	2198,5	2112	1974	1224	1112	1135	147	1050	