

### 网络 / 服务器机柜 TS IT

带适用于机柜温控系统的透明门

前视图

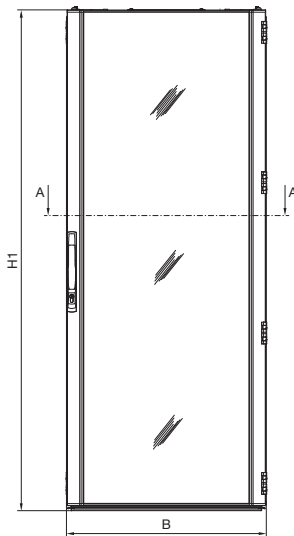

A - A 截面, 宽度 800 mm

侧视图

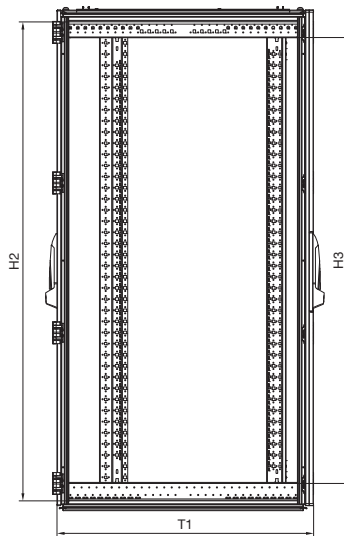

A - A 截面, 宽度 600 mm

后视图

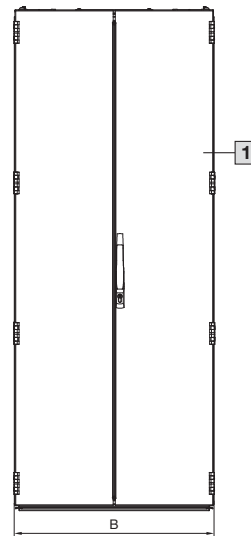

后视图, IP 55

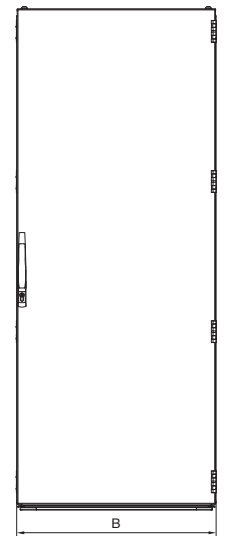

俯视图

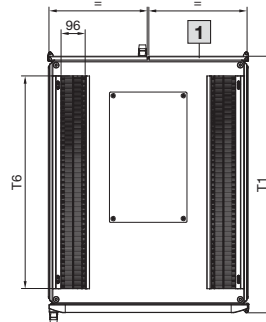

俯视图, IP 55

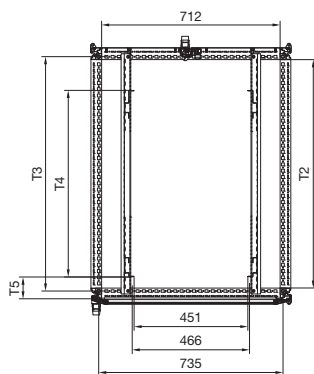
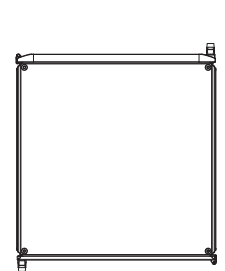

A - A 截面, IP 55

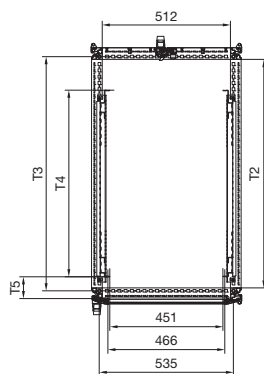

俯视图, 深度 600 mm

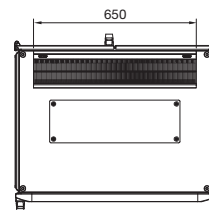

1 高度为 1200 mm 单门

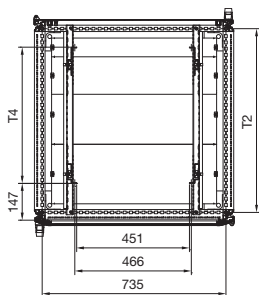

型号 DK	防护等级 IP 55	U	宽度尺寸 mm		高度尺寸 mm			深度尺寸 mm				
			B	H1	H2	H3	T1	T2	T3	T4	T5	T6
5503.120	-	24	797	1198.5	1112	974	824	712	735	545	147	650
5504.120	-	24	797	1198.5	1112	974	1024	912	935	745	87	850
5505.120	-	38	797	1798.5	1712	1574	824	712	735	545	147	650
5506.120	-	42	797	1998.5	1912	1774	624	512	535	445	87	650
5507.120	5507.130	42	797	1998.5	1912	1774	824	712	735	545	147	650
5508.120	-	42	597	1998.5	1912	1774	1024	912	935	745	87	850
5509.120	5509.130	42	797	1998.5	1912	1774	1024	912	935	745	87	850
5510.120	-	42	597	1998.5	1912	1774	1224	912	935	745	147	1050
5511.120	-	42	797	1998.5	1912	1774	1224	1112	1135	745	87	1050
5512.120	-	47	797	2198.5	2112	1974	824	712	735	545	147	650
-	5514.130	47	797	2198.5	2112	1974	1024	912	935	745	147	850

# 控制机柜

## IT 机柜系统

### 网络 / 服务器机柜 TS IT

带有适用于机柜温控系统的透明门，预安装

前视图

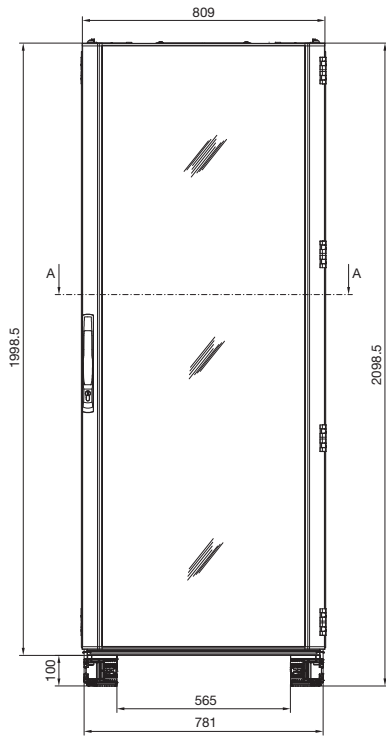

侧视图

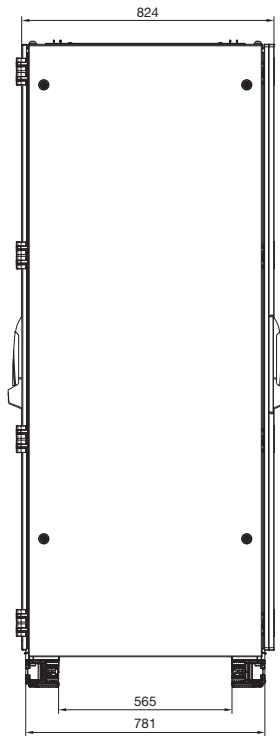

后视图

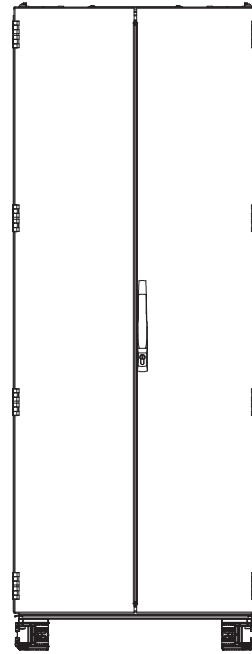

A - A 截面

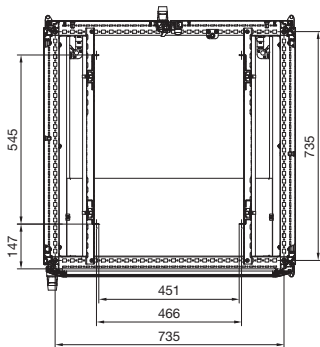

俯视图

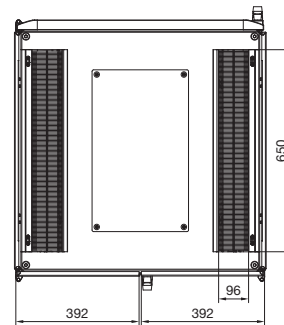

### 网络 / 服务器机柜 TS IT

带有适用于机房温控系统的通风网孔门

前视图

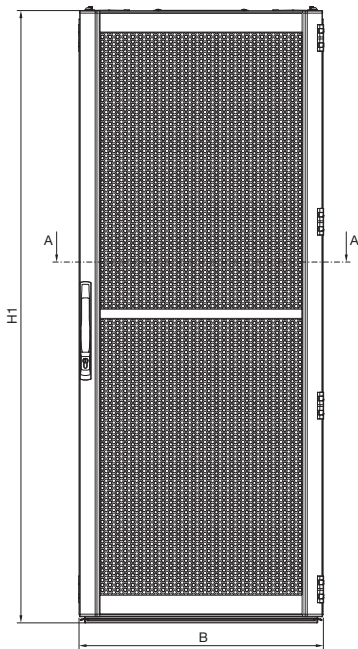

侧视图

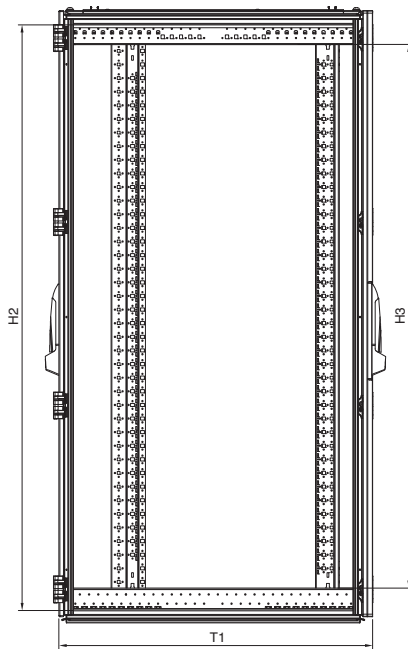

后视图

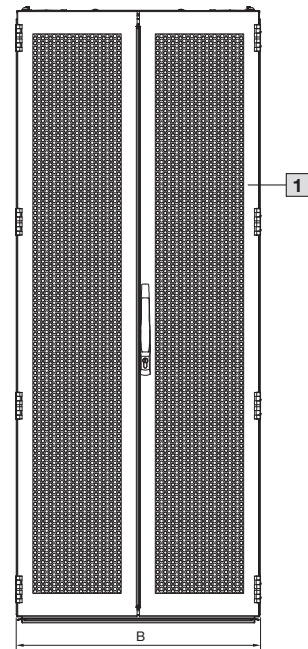

A - A 截面  
宽度 800 mm

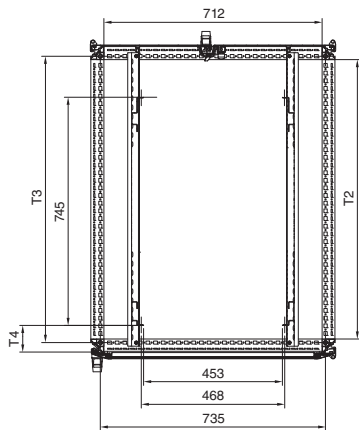

A - A 截面  
宽度 600 mm

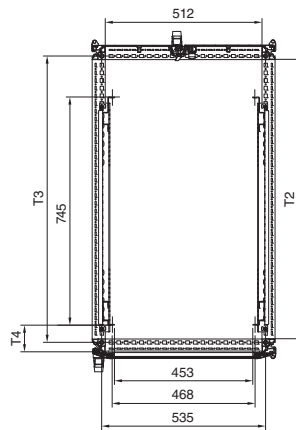

俯视图

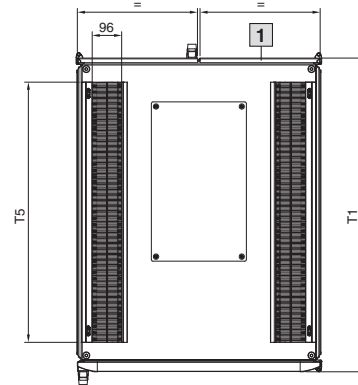

1 高度为 1200 mm 时单扇门

型号 DK	U	宽度尺寸 mm		高度尺寸 mm			深度尺寸 mm				
		B	H1	H2	H3	T1	T2	T3	T4	T5	
5504.110	24	797	1198.5	1112	974	1024	912	935	87	850	
5508.110	42	597	1998.5	1912	1774	1024	912	935	87	850	
5509.110	42	797	1998.5	1912	1774	1024	912	935	87	850	
5510.110	42	597	1998.5	1912	1774	1224	1112	1135	147	1050	
5511.110	42	797	1998.5	1912	1774	1224	1112	1135	147	1050	
5513.110	47	597	2198.5	2112	1974	1024	912	935	87	850	
5514.110	47	797	2198.5	2112	1974	1024	912	935	87	850	
5515.110	47	597	2198.5	2112	1974	1224	1112	1135	147	1050	
5516.110	47	797	2198.5	2112	1974	1224	1112	1135	147	1050	