

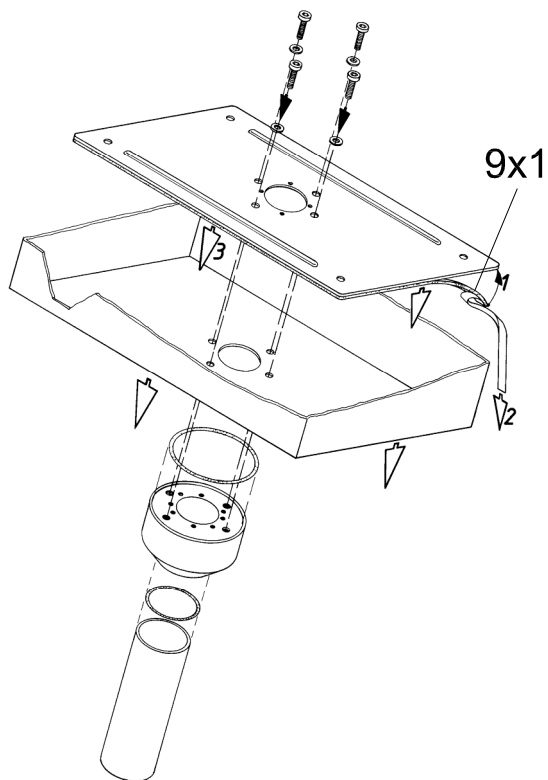







Raum für Verpackungsdatum  
Area for date of packing  
(MMJJTT / MMYDD)

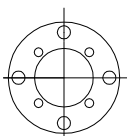

- |     |   |          |
|-----|---|----------|
| 4 X |  | M8x16    |
| 4 X |  | M 8      |
| 4 X |  | A 8.4    |
| 4 X |  | 8.1x16.2 |
| 1 X |  | 76x3     |
| 1 X |  | 9x1      |

Zchng.-Nr. / No. of dwg. : A2685700CP

Versandbeutel-Nr. / No. of accessory bag : 283206

Lieferanten-Nr. / No. of supplier :

