

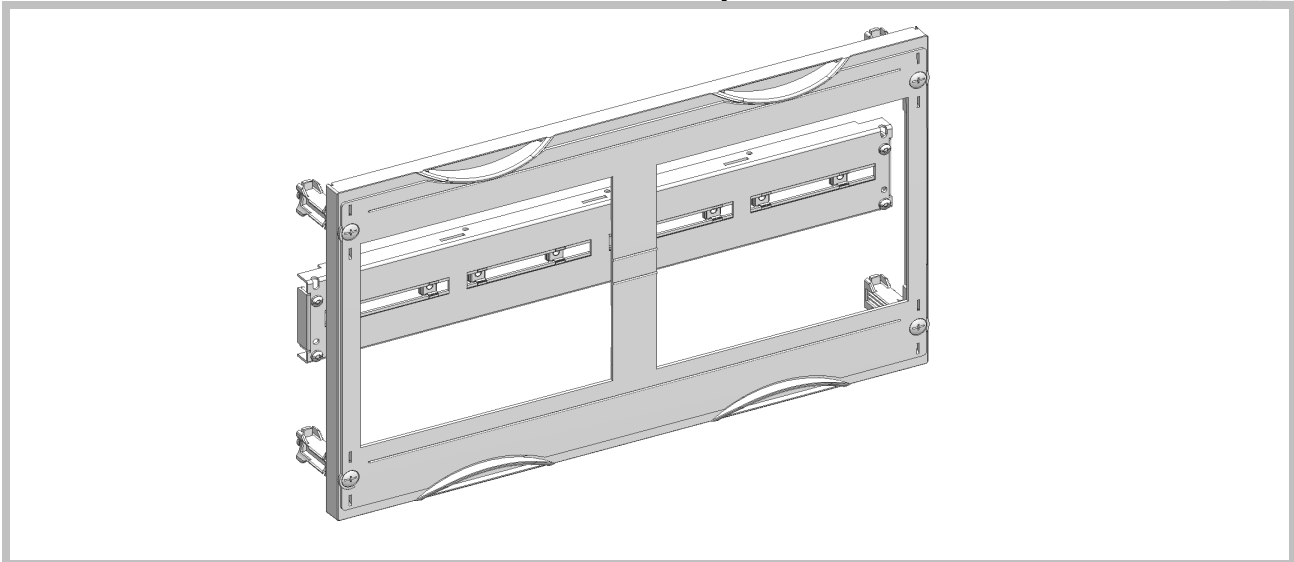





ISV NH-SI-Trenner-Modul für NH00

SV 9666.380/.390

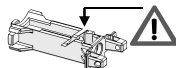
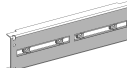
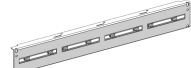

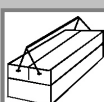

		SV 9666.380	SV 9666.390
	1 	4 x	4 x
	2.1 	1 x	---
	2.2 	---	1 x
	3  4,8x32	4 x	4 x
	4 	1 x	1 x





T25



PH2

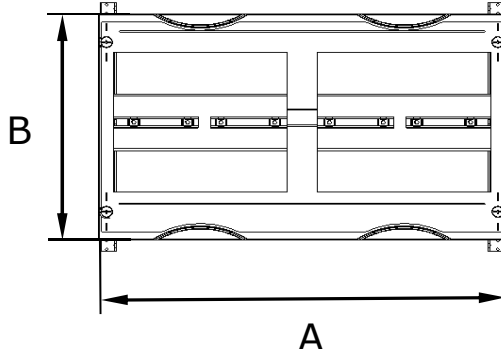

TS8

AE

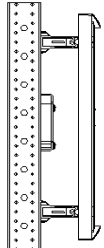



		A	B
SV 9666.380	1 / 2	250	300
SV 9666.390	2 / 2	500	300

ISV NH-SI-Trenner-Modul für NH00

SV 9666.380/.390



1 4x

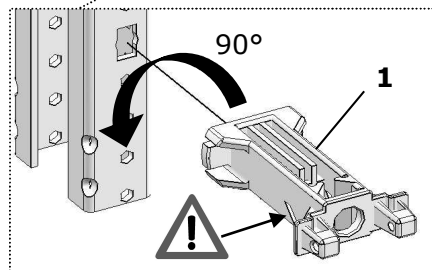
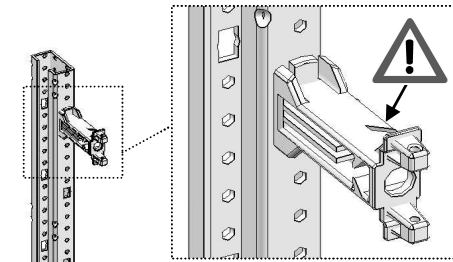
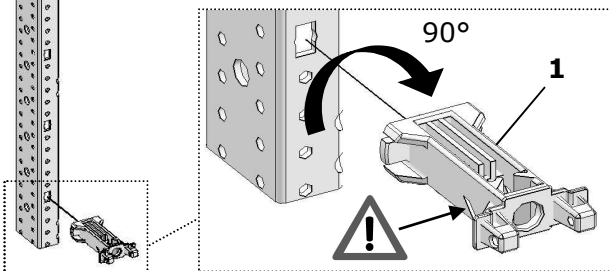
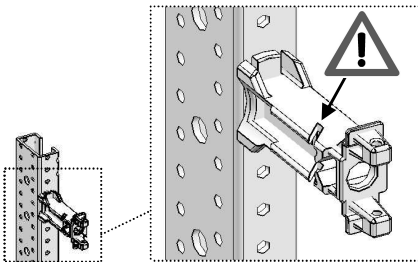

1

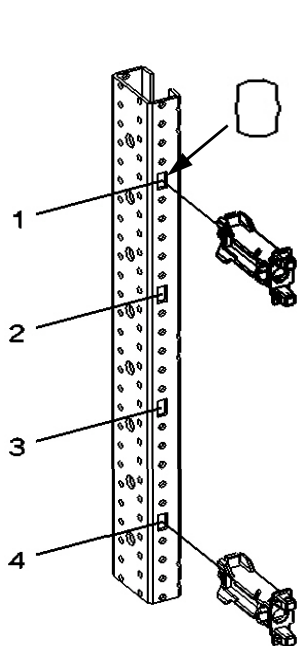

SV 9666.380	1 / 2	1 & 4
SV 9666.390	2 / 2	1 & 4

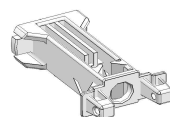
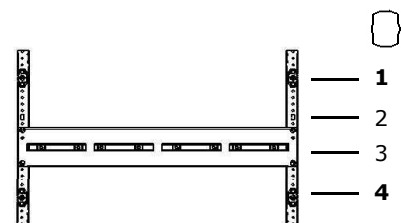

→ SV 9666.390 → 2/2 = 1 & 4

1.1

ISV NH-SI-Trenner-Modul für NH00

SV 9666.380/.390



2.1 1x



SV 9666.380

2.2 1x



SV 9666.390

3 4x
4,8x32



T25
AE / 2Nm
TS8 / 2Nm

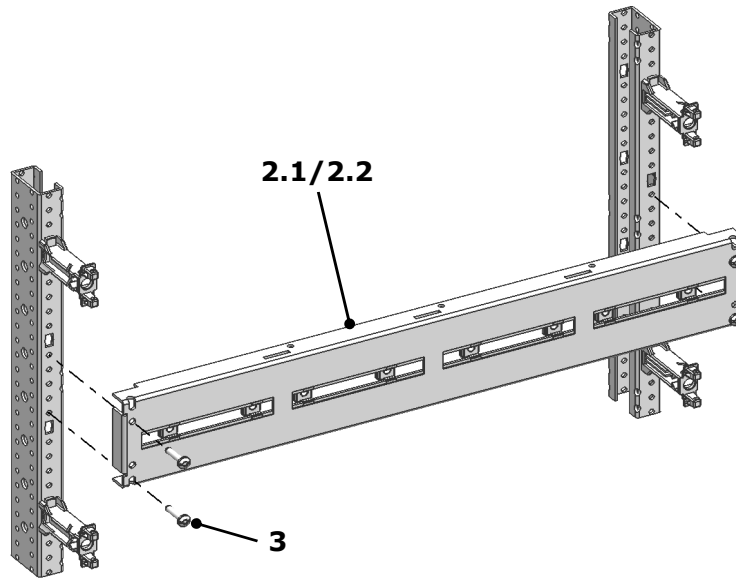

2

4 1x

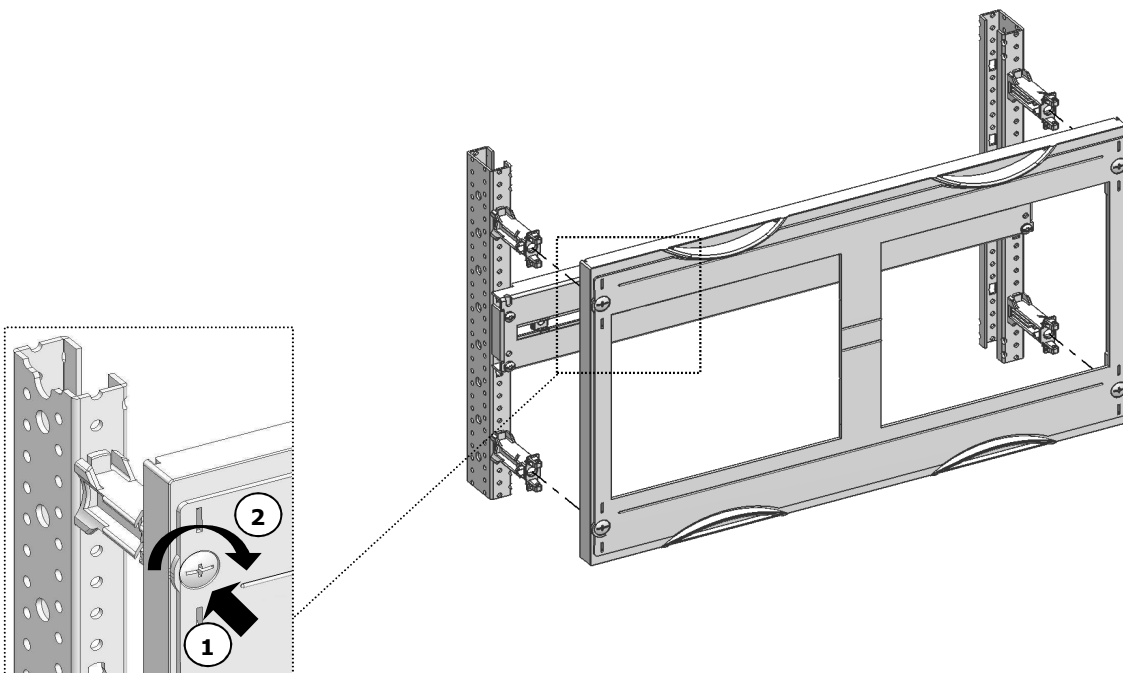

3

ISV NH-SI-Trenner-Modul für NH00

SV 9666.380/.390



- DE** Arbeiten an elektrischen Betriebsmitteln/Anlagen dürfen nur durch eine ausgebildete Elektrofachkraft gemäß DIN 57105 Teil 1 / VDE 0105 Teil 1 / DIN EN 50110-1 durchgeführt werden.
- GB** Only qualified electrical personell according to DIN 57105 part 1 / VDE 0105 part 1 / DIN EN 50110-1 are allowed to work on electrical installations.
- ES** Sólo electricistas cualificados según norma DIN 57105 part 1 / VDE 0105 part 1 / DIN EN 50110-1 están autorizados a trabajar en instalaciones.
- RU** Согласно DIN 57105, часть 1 / VDE0105, часть 1 / DIN EN 50110-1, на электрических установках разрешается работать только квалифицированному персоналу.

RITTAL GmbH & Co. KG
Postfach 1662 • D-35726 Herborn
Phone +49(0)2772 505-0 • Fax +49(0)2772 505-2319
E-Mail: info@rittal.de • www.rittal.de

EDV.-Nr.: 118464 / 0
02/12
printed in Germany

SCHALTSCHRÄNKE

STROMVERTEILUNG

KLIMATISIERUNG

IT-INFRASTRUKTUR

SOFTWARE & SERVICE

FRIEDHELM LOH GROUP

