

SCHALTBILDER

EZF 30/4 B

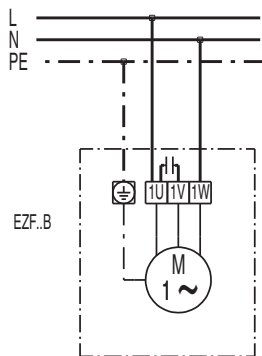
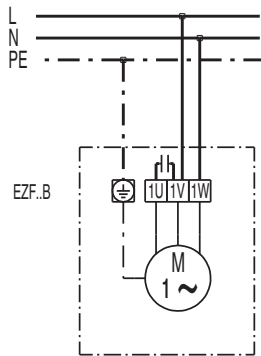

SCHALTBILDER

EZF 30/4 B

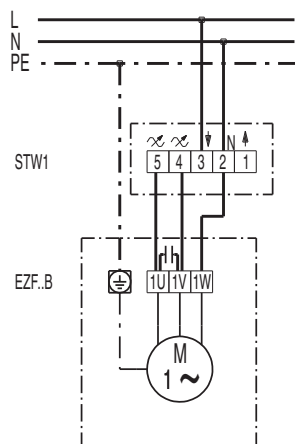
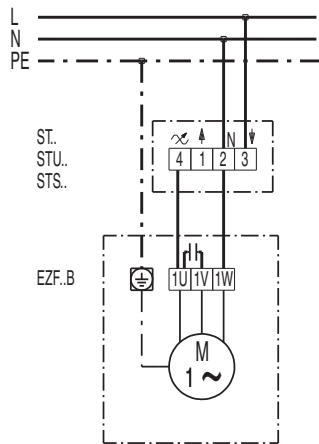

EZF 30/4 B

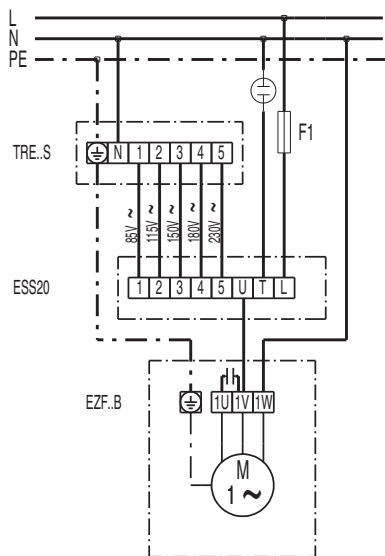
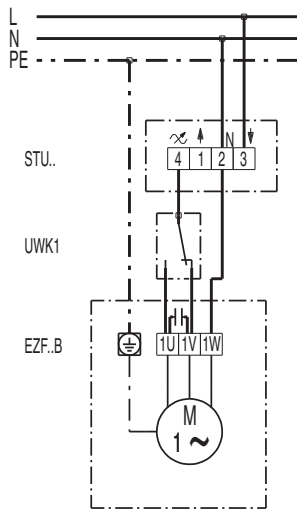

SCHALTBILDER

EZF 30/4 B

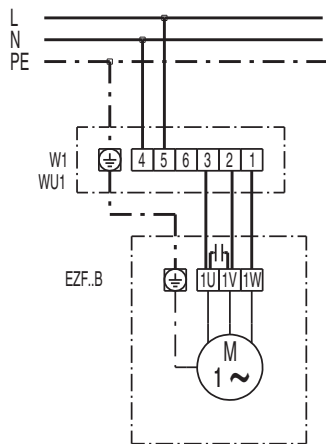
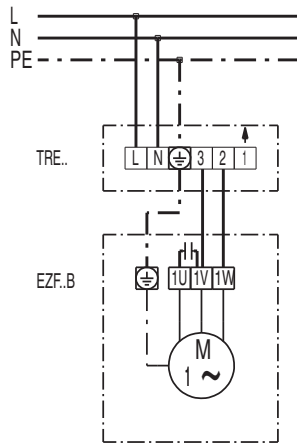

SCHALTBILDER

EZF 30/4 B

