

SCHALTBILDER

DZR 30/84 B

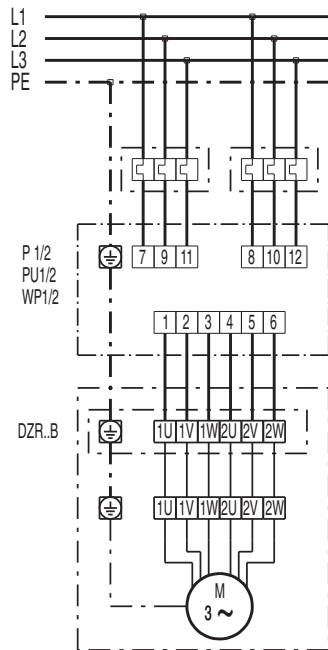

SCHALTBILDER

DZR 30/84 B

