

SCHALTBILDER

DZR 60/84 B

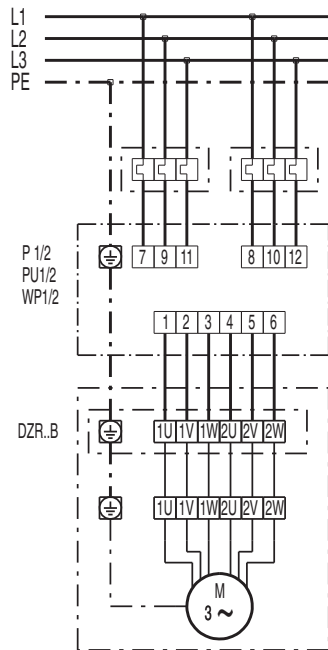

SCHALTBILDER

DZR 60/84 B

