

60800796
2,5m

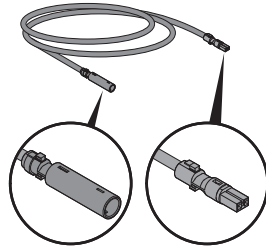

60800797
5,0m

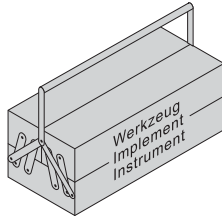
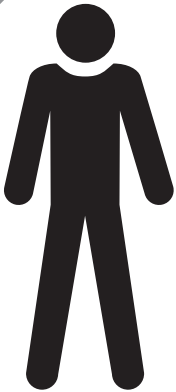
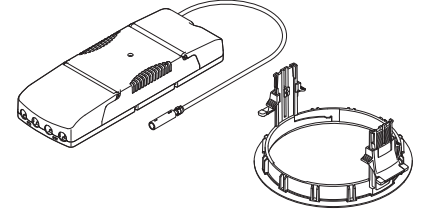
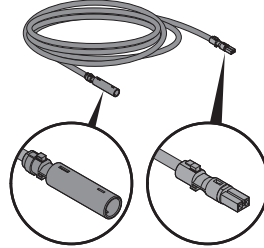

DE Die Montage und Inbetriebnahme darf nur von autorisiertem Fachpersonal durchgeführt werden.

NL De montage en inbedrijfstelling mogen enkel door erkend vakpersoneel worden uitgevoerd.

GB Installation and commissioning may only be carried out by authorized specialists.

NO/SE Monteringen och idrifttagandet får endast företas av auktoriserad fackpersonal.

FR L'installation et la mise en service doivent obligatoirement être effectuées par des techniciens.

FI Asennuksen ja käyttöönoton saa tehdä vain auktorisoitu ammattihenkilöstö.

IT Montaggio ed avviamento devono essere eseguiti solo da personale specializzato.

ES El montaje y la puesta en marcha sólo puede ser realizado por personal especializado autorizado.

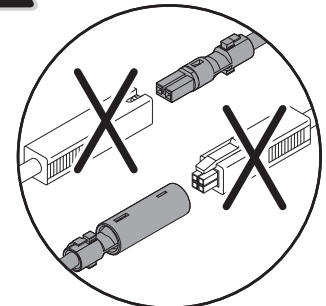
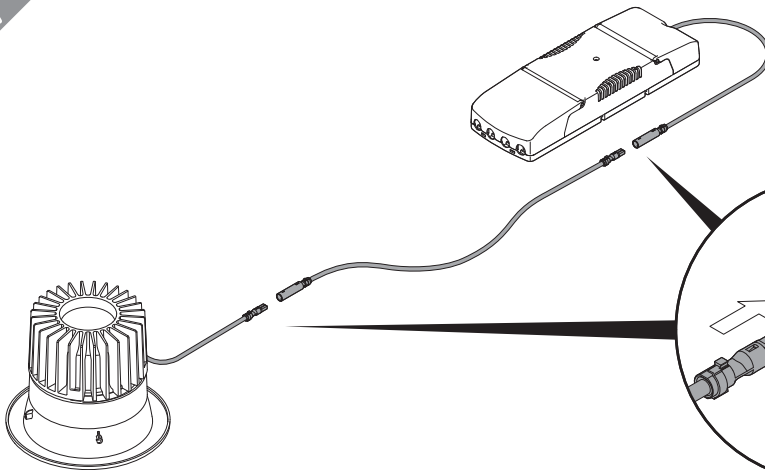

Technische Änderungen vorbehalten. - Specifications subject to change without notice. - Modifications techniques sans préavis.
Modifiche tecniche senza preavviso. - Technische wijzigingen voorbehouden.
Med forbehold om tekniske endringer. - Oikeudet teknisiin muutoksiin pidätetään. - Modificaciones técnicas sin preaviso.