



identification 
for 0,75mm²

male contact



identification

female contact

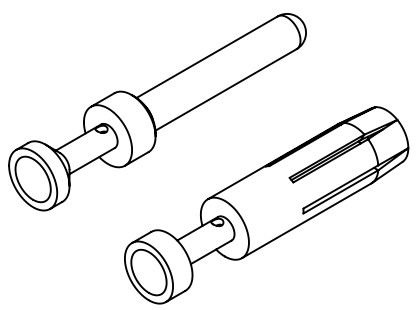
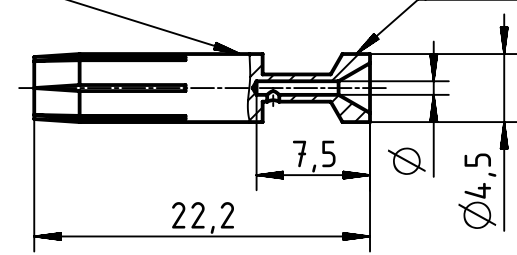
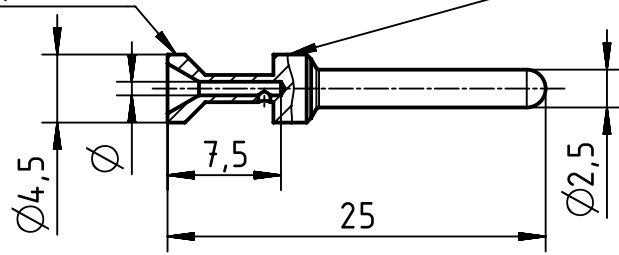
identification 
for 0,75mm²

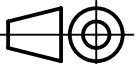

Part no. 09 33 200		Ø	Wire gauge		Stripping length	Identification	Recommended crimping tools			
gold plated			mm ²	AWG			09 99 000 0888	09 99 000 0001	09 99 000 0110	09 99 000 0021
male contact	female contact									
6117	6217	0,9	0,14-0,37	26,22	7,5	no groove	X	X		
6122	6222	1,15	0,5	20		no groove	X	X	X	X
6115	6215	1,3	0,75	18		1 groove 	X	X	X	X
6118	6218	1,45	1			1 groove	X	X	X	X
6116	6216	1,75	1,5	16		2 grooves	X	X	X	X
6123	6223	2,25	2,5	14		3 grooves	X	X	X	X
6119	6221	2,85	4	12		no groove	X	X	X	

	All Dimensions in mm Original Size DIN A4	Scale 2:1	Free size tol.			Ref.
	All rights reserved Department EL PD	Created by FINKEV	Inspected by NICHTERLEIN	Standardisation RUETERA	Date 2019-01-18	State Final Release
HARTING Electric GmbH & Co. KG D-32339 Espelkamp		Title Han E HMC contacts male/female				Doc-Key / ECM-Nr. 100088836/UGD/003/A 500000145820
Type TB	Number 09 33 200 6XXX				Rev. A	Page 1/1