

**i** Info on (non-) replaceability:

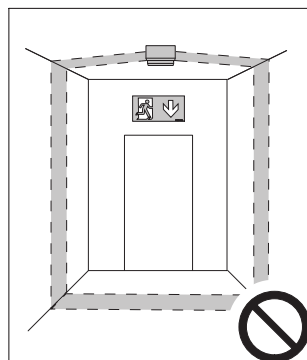

3 i (page 3)

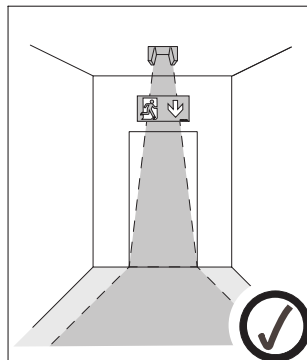
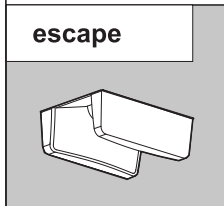
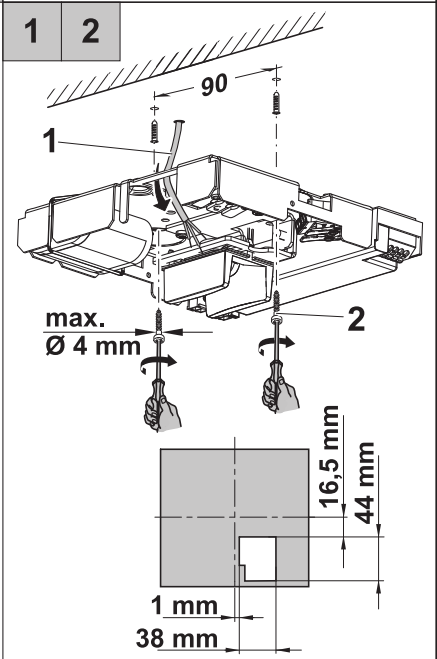
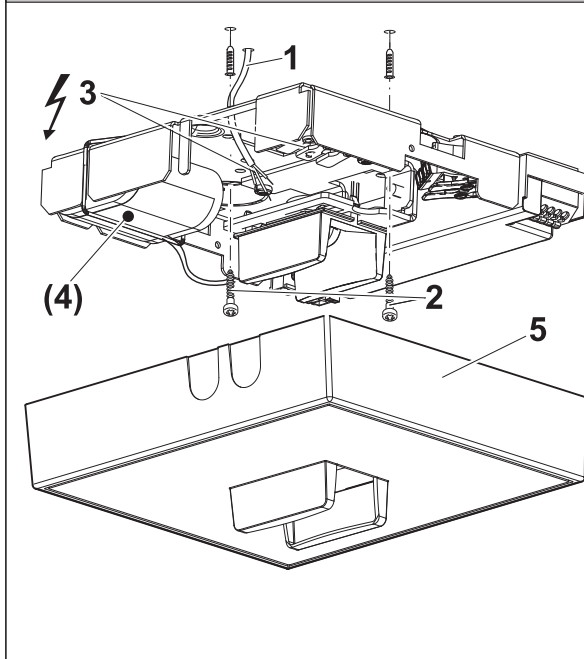

OPTION!



max. 2,5 mm<sup>2</sup>

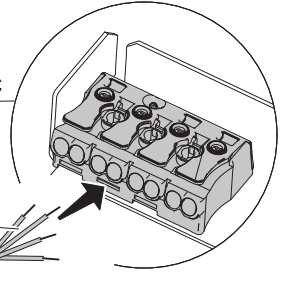
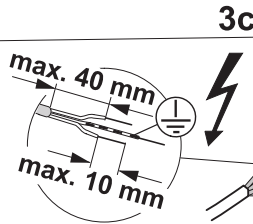
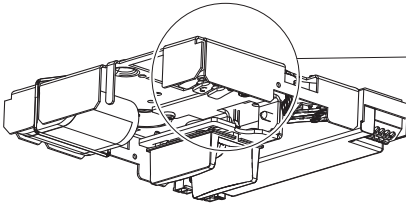
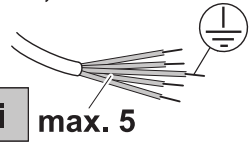
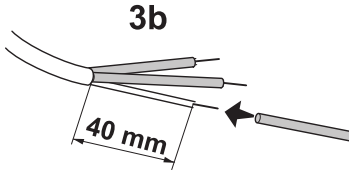
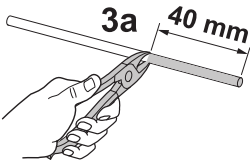

## (4) Battery connection

Commissioned Date:  
Inbetriebnahmedatum:

i OPTION: E3

i OPTION: ExD

(4a)

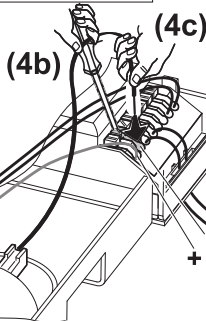

(4b)

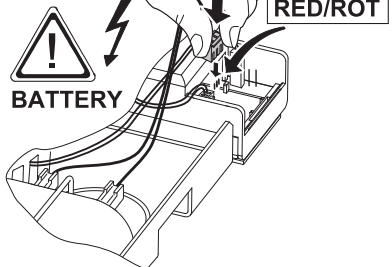

5

(acc. IEC/EN 60598-2-22)

mode of operation: 0...6

facilities: A...F

5a

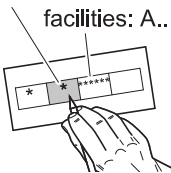

i OPTION

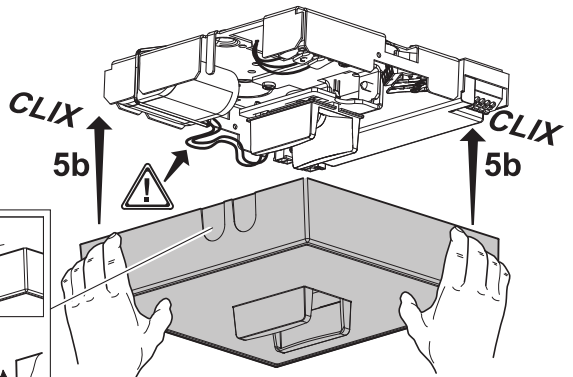
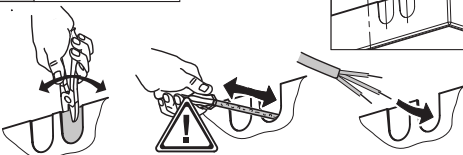

# ExD

## OPTION:

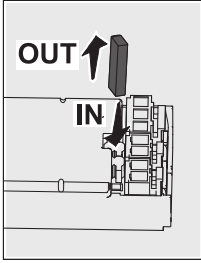

### Jumper IN (delivery state)

\* 1 \* \* \* \* \*

#### Maintained light

Dauerlicht  
Régime permanent  
Modalità sempre accesa  
Permanente verlichting  
Luz permanente

### Jumper OUT

\* 0 \* \* \* \* \*

#### Non-maintained light

Bereitschaftslicht  
Régime non permanent  
Modalità solo emergenza  
Niet-permanente verlichting  
Circuito de reserva

i

Jumper selection only valid for stand-alone luminaires. System overwrites selection to maintained light.

i

(acc. IEC/EN 60598-2-22) mode of operation: 0...6 facilities: A...F

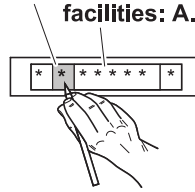

# ExD

## OPTION

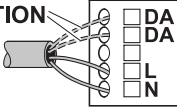

X \* ABCDEF \*



### LED GREEN / GRÜN

### Status

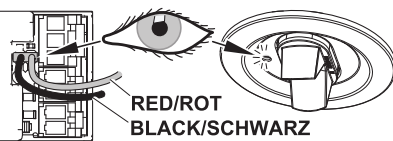
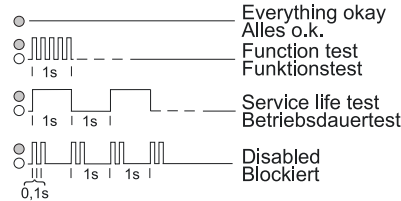

### LED RED / ROT

### Status

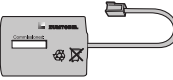
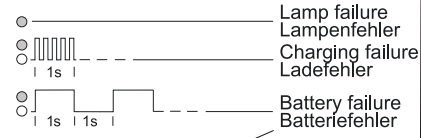

Change battery  
Akku wechseln

i



# E3



Do not remove Jumper or change Jumper position. Jumper configures autonomy time. (manufacturer internal-only configuration)

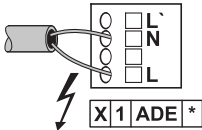

### Non-maintained mode

Bereitschaftsschaltung  
Eclairage non permanent  
Circuito in emergenza  
Stand-byschakeling  
Encendido no permanente

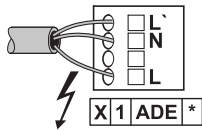

### Switched maintained mode

Geschaltetes Dauerlicht  
Ecl permanent active  
luce accesa permanente  
geschakelt permanent licht  
Luz constante encendida

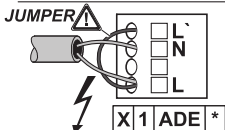

### Maintained mode

Dauerschaltung  
Mode permanent  
Circuito permanent  
Permanente schakeling  
Encendido permanente

# ECC / ECS / ECP

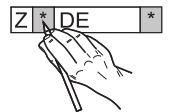
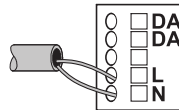

# ECD

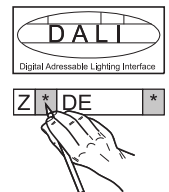
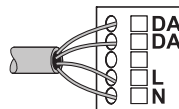

## **DE** Hinweise für die Montage und den Betrieb!

Die Montage und Inbetriebnahme der Leuchte sowie jede Veränderung an der Leuchte darf nur von autorisierten Fachkräften (qualifizierter Elektriker) durchgeführt werden. Die nationalen Errichtbestimmungen sind zu beachten. Vor jeder Arbeit an der Leuchte ist diese vom Netz zu trennen.  
**Hot Plug-in ist nicht möglich und kann zu Schäden an der Leuchte führen!**  
Der Hersteller haftet nicht für Schäden, die aus fehlerhafter Montage, aus unsachgemäßem Betrieb oder unautorisierten Veränderungen an der Leuchte resultieren.



Die Lichtquelle dieser Leuchte darf nur vom Hersteller oder einem von ihm beauftragten Servicetechniker oder einer vergleichbar qualifizierten Person ausgetauscht werden.

**Vorsicht, Gefahr eines elektrischen Schlags.**

Technische Änderungen vorbehalten! Bei Fragen wenden sie sich an den Hersteller.

## **EN** Instructions for installation and operation!

The installation and commissioning of the luminaire as well as any modification to the luminaire may only be performed by authorized personnel (qualified electrician). National installation regulations must be observed. Before any work on the appliance is done, it must be disconnected from mains.

**Hot plug-in is not an option and may cause damage to the lamp or luminaire!**

The manufacturer is not liable for damages resulting from improper or faulty installation or operation or from unauthorized modifications to the luminaire.



The light source contained in this luminaire shall only be replaced by the manufacturer or his service agent or a similarly qualified person.

**Caution, risk of electric shock!**

Specifications are subject to change without notice! If you have questions, please contact the manufacturer.

## **FR** Instructions pour l'installation et l'utilisation!

L'installation et la mise en service du luminaire ainsi que toute modification au luminaire doivent être effectuées par un personnel autorisé (électricien qualifié). Les règles nationales d'installation doivent être respectées. Avant toute intervention sur l'appareil, il doit être débranché de son alimentation.

**Le branchement à chaud est interdit, et peut endommager à la lampe ou le luminaire!**

Le fabricant décline toute responsabilité pour les dommages résultant d'une mauvaise installation ou opération, ou d'une modification non autorisée du luminaire.



La source lumineuse présente dans le luminaire ne peut être remplacée que par le fabricant, par son service technique ou une personne qualifiée.

**Avertissement, risque de choc électrique.**

Sous réserve de modifications des spécifications techniques! Pour toute question, contactez le fabricant.

## **IT** Istruzioni per l'installazione e il funzionamento!

L'installazione e la messa in servizio degli apparecchi, nonché qualsiasi modifica dell'apparecchio può essere eseguita solo da personale autorizzato (elettricista qualificato). Le norme nazionali di installazione devono essere rispettate. Prima di qualsiasi intervento sull'apparecchio, questo deve essere scollegato dalla rete.

**Non è possibile un Hot Plug In e può causare danni alla lampada o all'apparecchio!**

Il produttore non si assume alcuna responsabilità per i danni derivanti da un'installazione impropria o difettosa, o per modifiche non autorizzate apportate all'apparecchio.



La sorgente luminosa contenuta in questo apparecchio può essere sostituita solo dal produttore o da un centro assistenza autorizzato o da una persona qualificata.

**Attenzione, rischio di folgorazione!** Modifiche tecniche sono soggette a cambiamenti senza preavviso! Se avete domande, si prega di contattare il produttore.

## **NL** Aanwijzingen voor installatie en bediening!

De installatie en inbedrijfstelling van het armatuur, alsook elke wijziging in of aan het armatuur mag alleen door bevoegd personeel (elektricien) worden uitgevoerd. De nationale installatie voorschriften moeten worden nageleefd. Voor alle werkzaamheden aan het apparaat, moet deze worden losgekoppeld van het net.

**Hot plug-in is niet mogelijk en kan schade aan de lamp veroorzaken!**

De fabrikant is niet aansprakelijk voor schade als gevolg van onjuiste foutieve installatie, bediening of schade welke het gevolg is van niet geautoriseerde wijzigingen aan het armatuur.



De lichtbron in dit armatuur mag enkel door de fabrikant, een service agent of een gelijkwaardig gekwalificeerd person vervangen worden.

**WAARSCHUWING: Gevaar voor elektrische schokken.**

Technische wijzigingen voorbehouden! Als u vragen hebt, kunt u contact opnemen met de fabrikant.



Die Leuchte sollte so positioniert sein, dass in einem Abstand näher als **0,71 m** vermieden wird, dauerhaft in die Leuchte zu starren. The luminaire should be positioned so that prolonged staring into the luminaire at a distance closer than **0,71 m** is not expected. Le luminaire doit être positionné de façon à ce que personne ne puisse le fixer du regard de manière prolongée à une distance inférieure à **0,71 m**. Posizionare l'apparecchio di illuminazione in modo da evitare di guardarvi a lungo ad una distanza inferiore a **0,71 m**. De armatuur moet zo worden geplaatst dat langdurig staren in de armatuur op een afstand van minder dan **0,71 m** niet wordt verwacht.



Chemische Beständigkeit beachten. Nur kunststoffverträgliche Reinigungsmittel verwenden.

Note: Due to problems with chemical resistance, choose cleaning materials which are suitable for plastic.

Respectez la résistance chimique du matériel: n'utilisez que des détergents compatibles avec les matières synthétiques.

Rispettare la resistenza chimica del materiale: utilizzare solo detersivi compatibili con materiali plastici.

Rekening houden met chemische weerstand. Gelieve enkel reinigingsmiddelen te gebruiken die Kunststoffvriendelijk zijn.