

D Für die Installation und für den Betrieb der Leuchten sind die nationalen Sicherheitsvorschriften zu beachten.

GB Please note national safety instructions for installation and operation of this luminaire.

F Pour l'installation et le fonctionnement des luminaires il est impératif de respecter les normes nationales de sécurité en vigueur.

PL W celu prawidłowej instalacji i poprawnego działania oprawy należy przestrzegać krajowych przepisów bezpieczeństwa.

E Para la instalación y la puesta en funcionamiento de las luminarias deben observarse las normas nacionales de seguridad.

D Die Lichtquelle dieser Leuchte darf nur vom Hersteller oder einem von ihm beauftragten Servicetechniker oder einer vergleichbar qualifizierten Person ersetzt werden.

GB Only the manufacturer, an instructed service technician or another equally qualified person is allowed to replace the light source of this luminaire.

F La source lumineuse de ce luminaire ne peut être remplacée que par le fabricant, un technicien de service mandaté par celui-ci ou une personne présentant une qualification analogue.

PL Wymiany źródła światła oprawy oświetleniowej może dokonać wyłącznie producent lub uprawniony pracownik serwisu lub osoba o podobnych kwalifikacjach.

E La fuente de luz de esta luminaria solamente podrá ser sustituida por el fabricante o una persona designada por este, ya sea un técnico de servicio u otra persona debidamente cualificada.

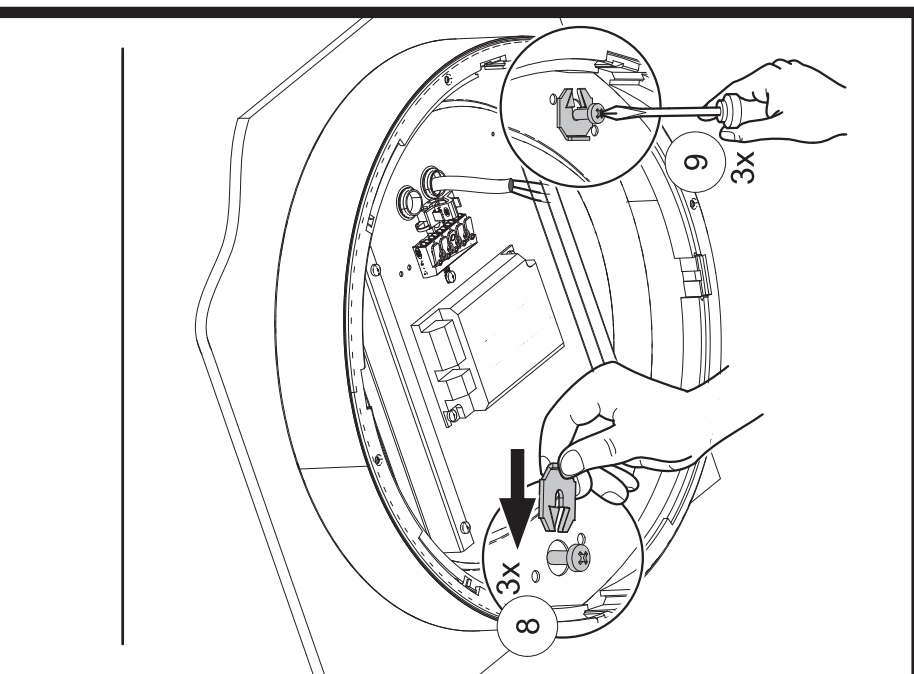
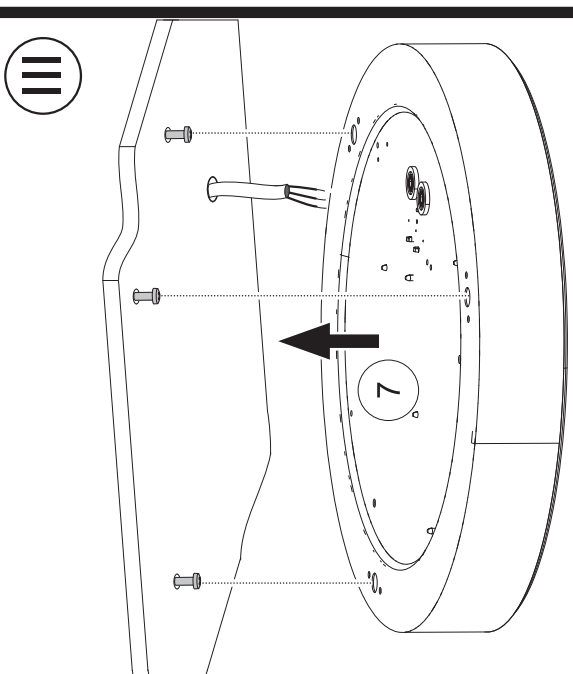
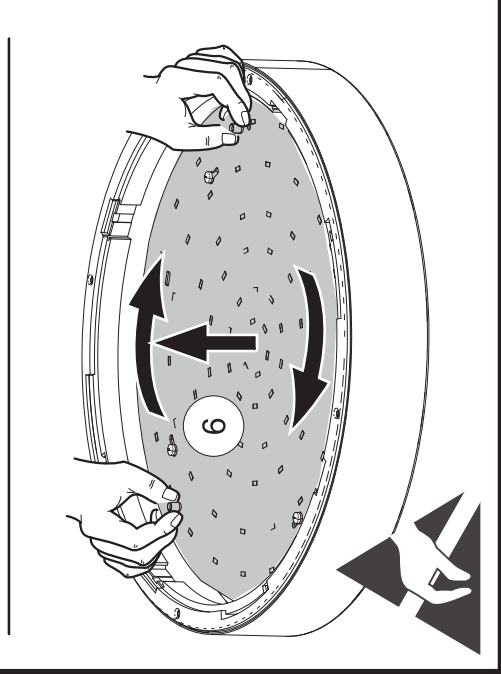
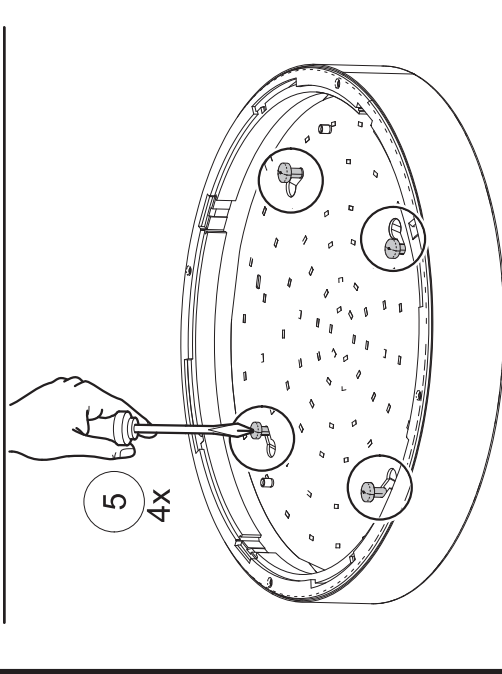
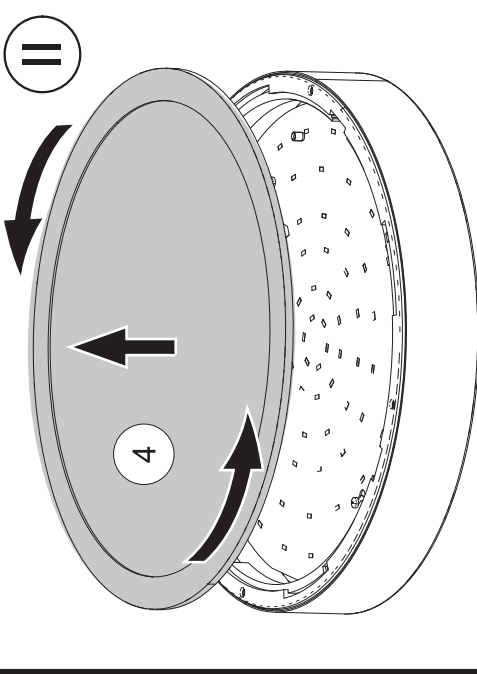
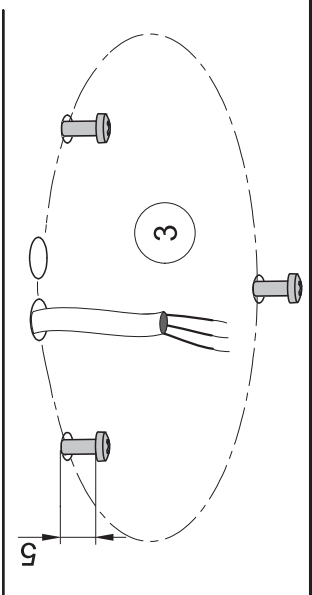
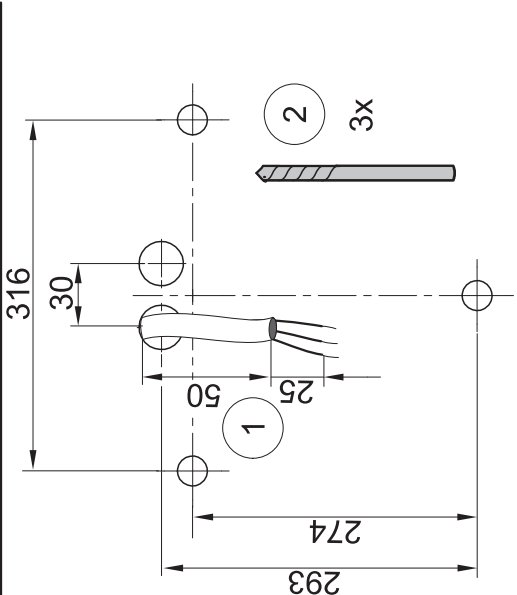
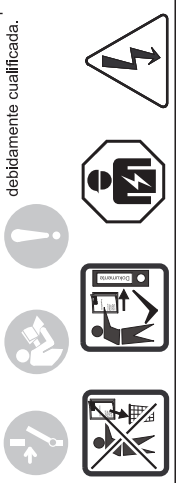



IV

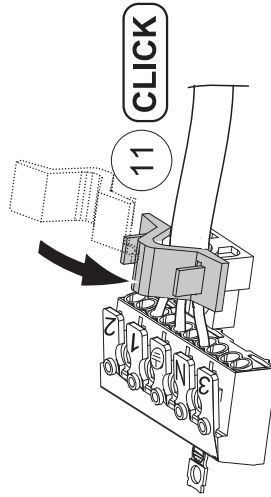
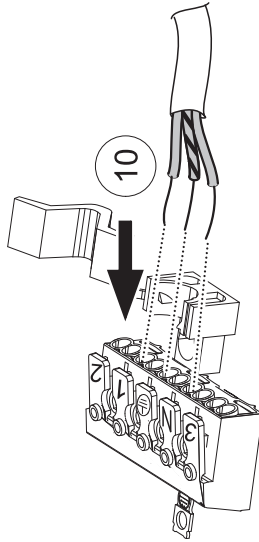
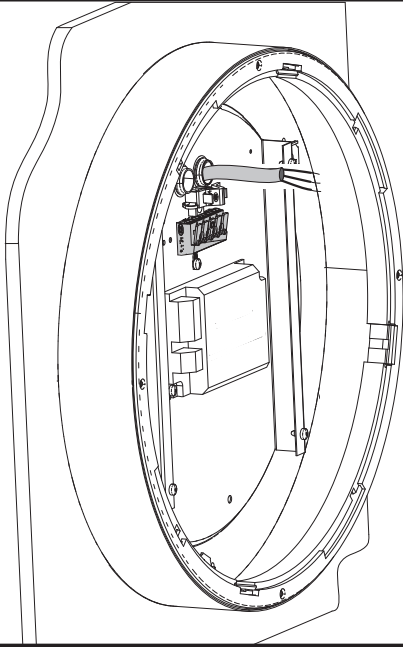

	mm ²	A	Ø	A
0,5-2,5mm ²	0,5-1,0	9	0,8-1,2	9
	1,5-2,5	12	1,3-1,8	12
			max. ø 1,8mm	

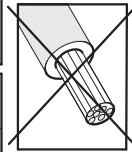

V

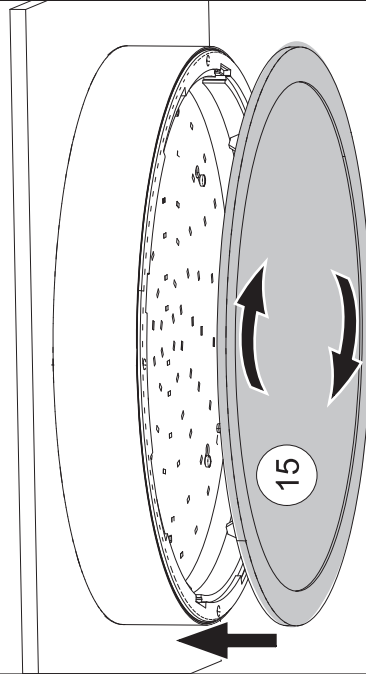
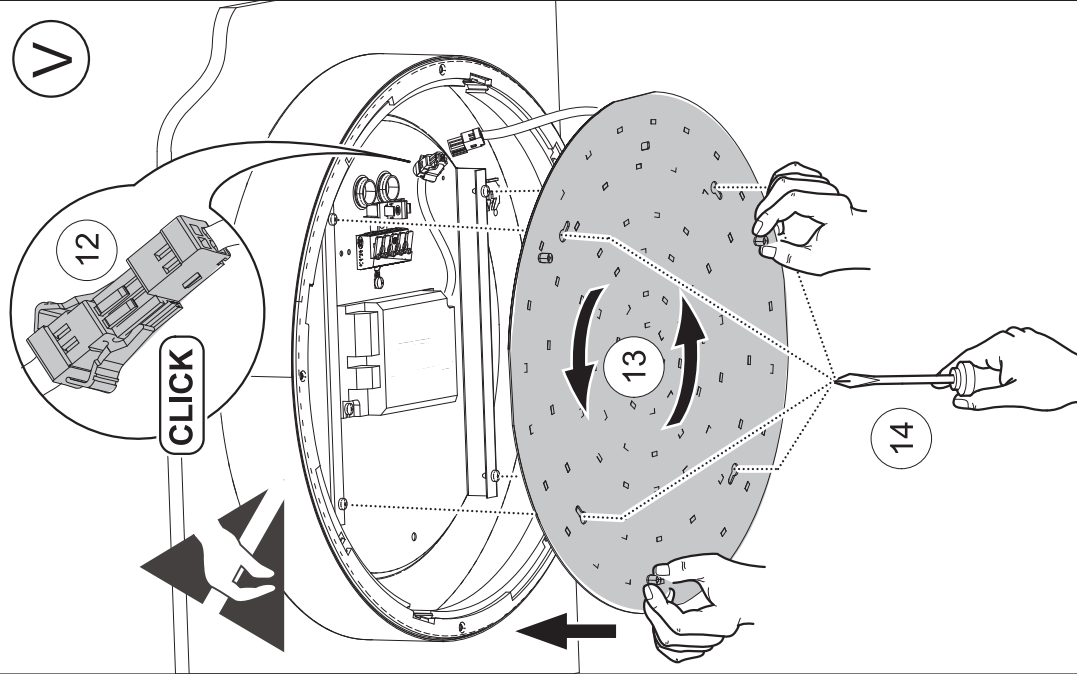

ADLR 410

Montageanleitung

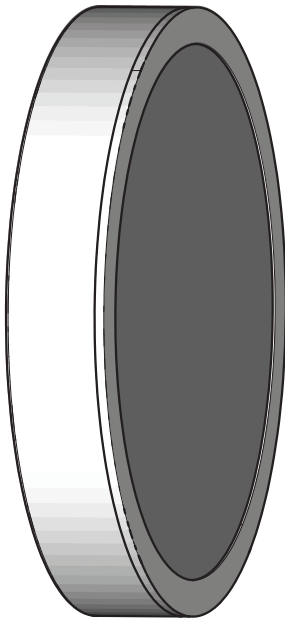

RIDI Leuchten GmbH
 Hauptstrasse 31 - 33
 D-72417 Jungingen
 Tel.: 07477/872-0
 Fax.: 07477/872-48
 eMail: info@ridi.de
 Internet: www.ridi.de