

## Montageanleitung

Ⓒ mounting instruction Ⓕ Notice de montage Ⓒ Instrukcja montażu  
Ⓔ Instrucciones de montaje Ⓓ Istruzioni di montaggio

## LENSES-S

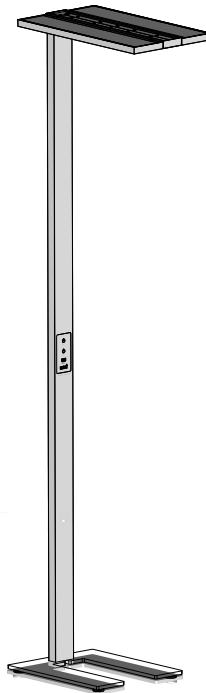

RIDI Leuchten GmbH  
Hauptstrasse 31 - 33 · D-72417 Jungingen  
Tel. 07477/872-0 · Fax 07477/872-48  
kontakt@ridi-group.de · www.ridi-group.com



- (D) Für die Installation und für den Betrieb der Leuchten sind die nationalen Sicherheitsvorschriften zu beachten.
- (GB) Please note national safety instructions for installation and operation of this luminaire.
- (F) Pour l'installation et le fonctionnement des luminaires il est impératif de respecter les normes nationales de sécurité en vigueur.
- (PL) W celu prawidłowej instalacji i poprawnego działania oprawy należy przestrzegać krajowych przepisów bezpieczeństwa.
- (E) Para la instalación y la puesta en funcionamiento de las luminarias deben observarse las normas nacionales de seguridad.
- (I) Per l'installazione e il funzionamento delle lampade si fa riferimento alle normative di sicurezza nazionali.

- (D) Die Lichtquelle dieser Leuchte ist nicht ersetzbar, wenn die Lichtquelle ihr Lebensdauerende erreicht hat, ist die gesamte Leuchte zu ersetzen.
- (GB) The light source of this luminaire is not replaceable. When light source has reached end of life-time the complete luminaire has to be replaced.
- (F) La source lumineuse de ce luminaire n'est pas remplaçable. Quand la source lumineuse aura atteint la limite de sa durée de vie, le luminaire complet doit être remplacé.
- (PL) Nie ma możliwości wymiany źródła światła w tej oprawie oświetleniowej, po zakończeniu żywotności źródła światła, należy wymienić całą oprawę oświetleniową.
- (E) La fuente luminica de esta luminaria no se puede sustituir. Cuando la fuente luminica ha alcanzado el final de su vida útil, hay que sustituir toda la luminaria.
- (I) La sorgente di luce di questa lampada non è sostituibile, una volta esaurita la sua durata si deve sostituire l'intera lampada.

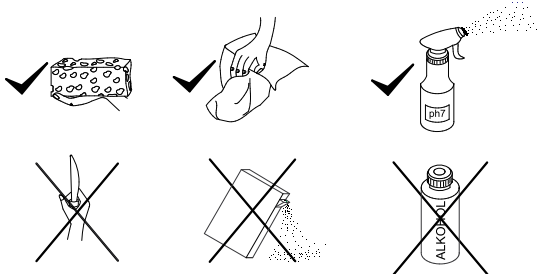

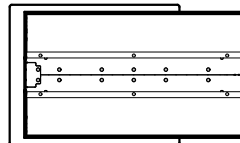
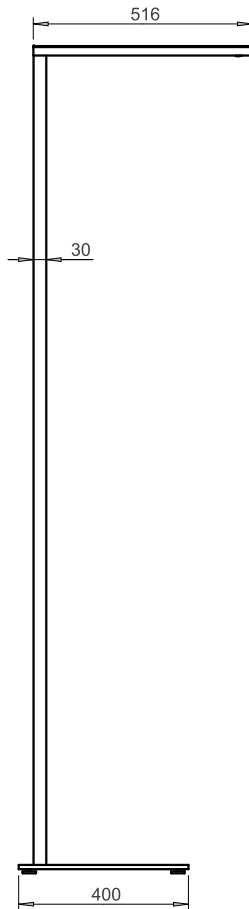
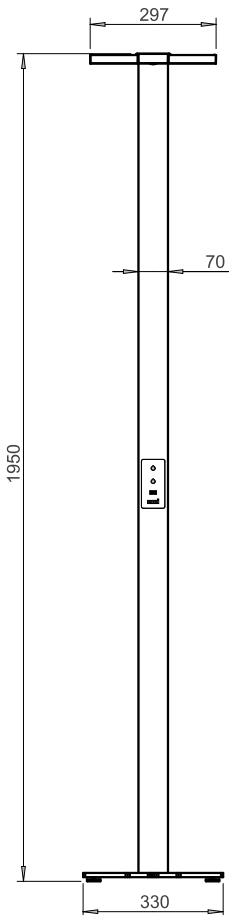

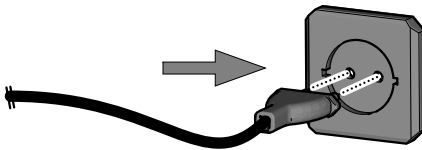
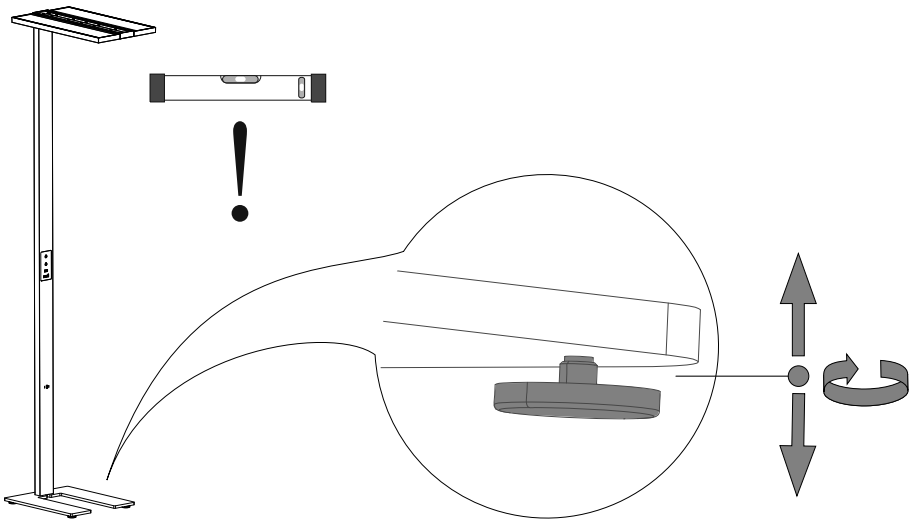
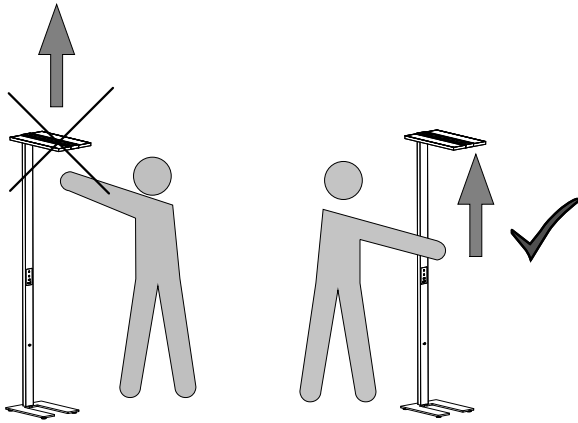

# LENSES-S 2000/DA840 SEN-TP-USB

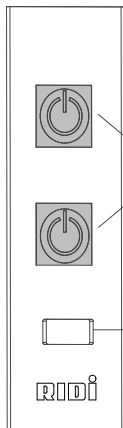
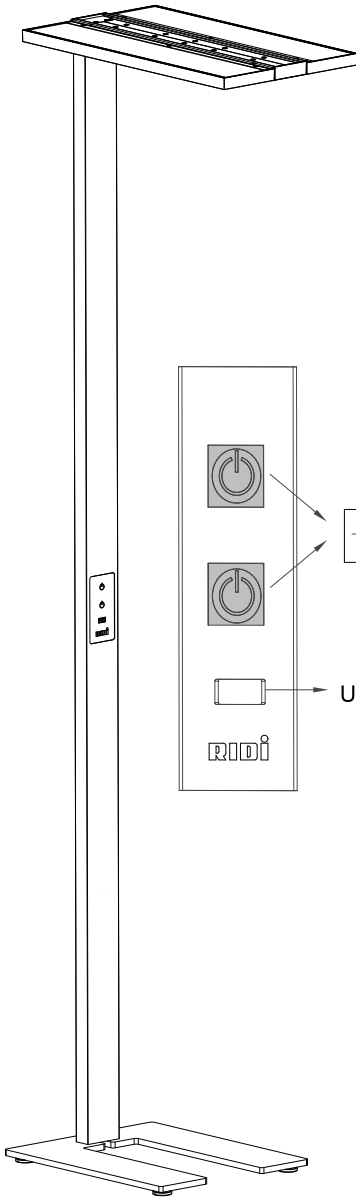

ON/OFF



USB 5V/2A

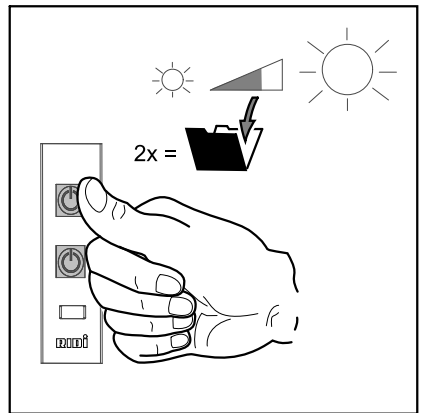

# LENSES-S 2000/DA840 TP-USB

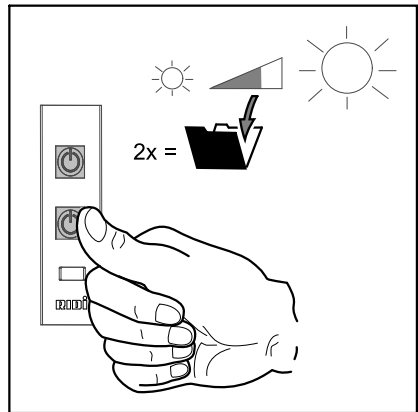
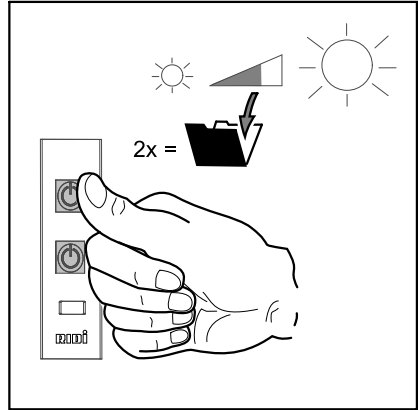
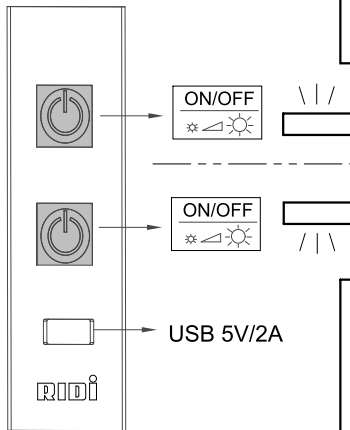
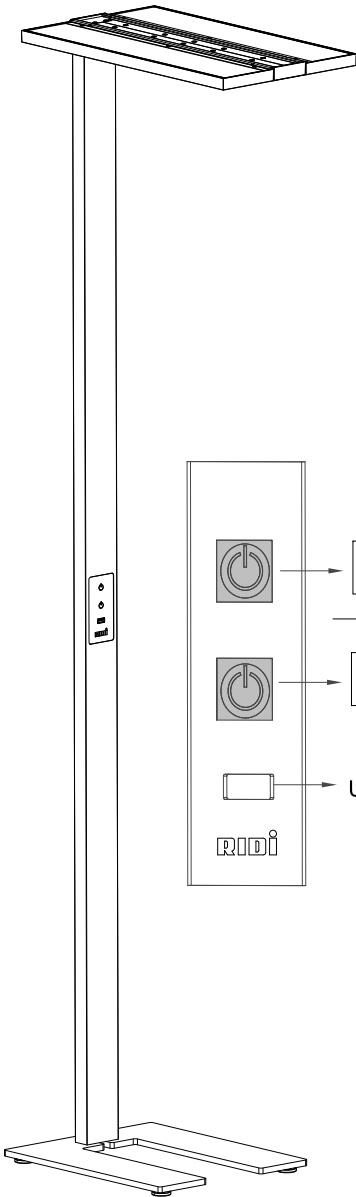

# LENSES-S 2000/DA840 SEN

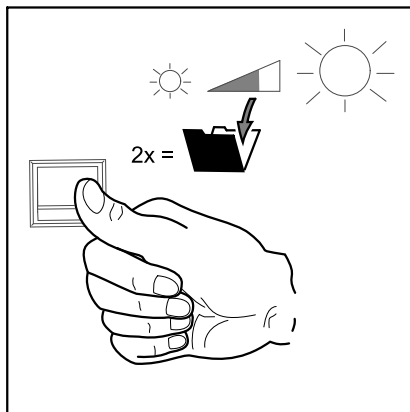
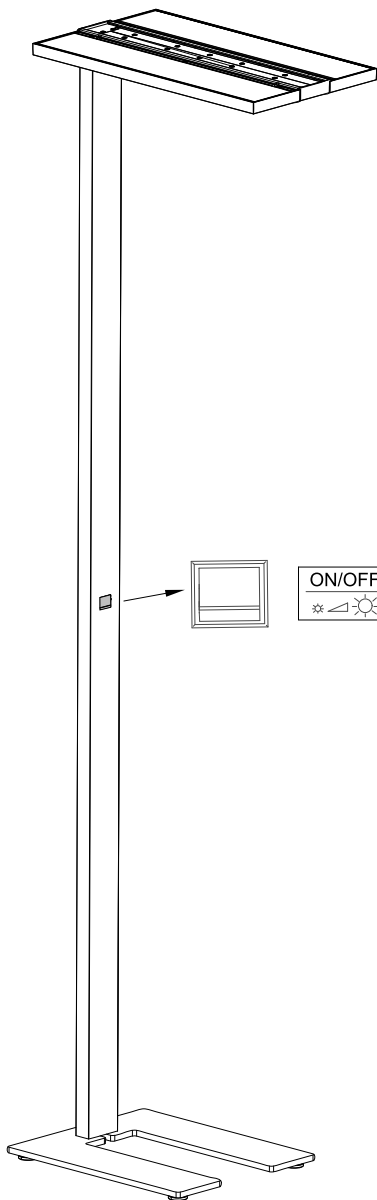

# LENSES-S 2000/DA840

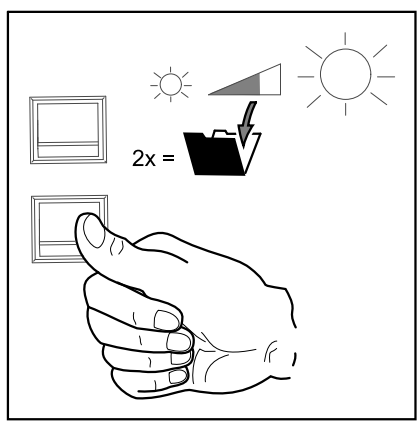
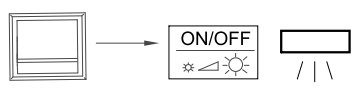
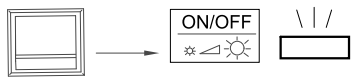
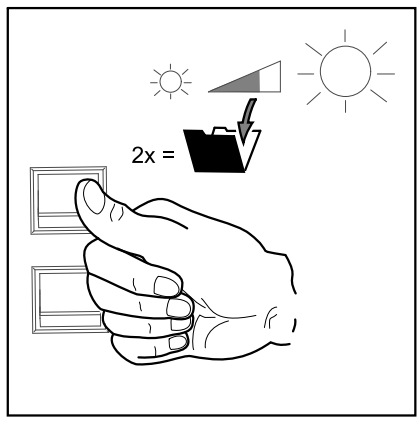
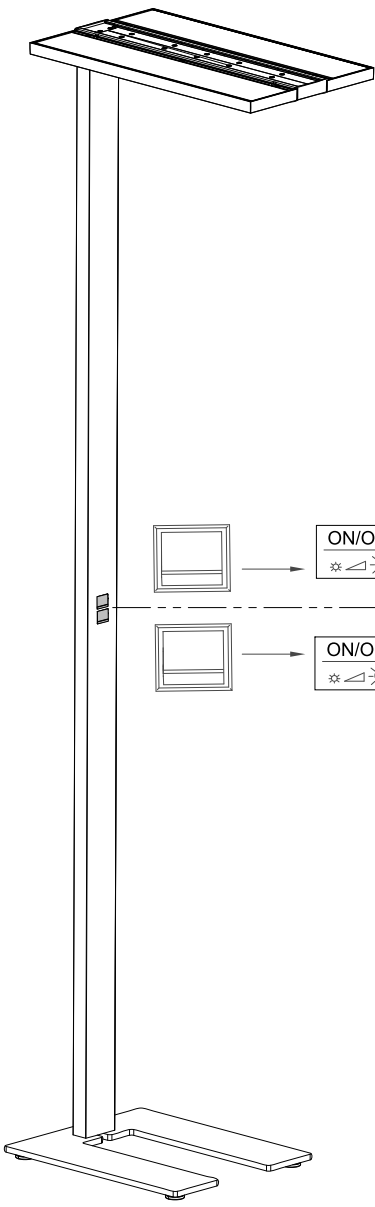



# LENSES-S 2000/ND840

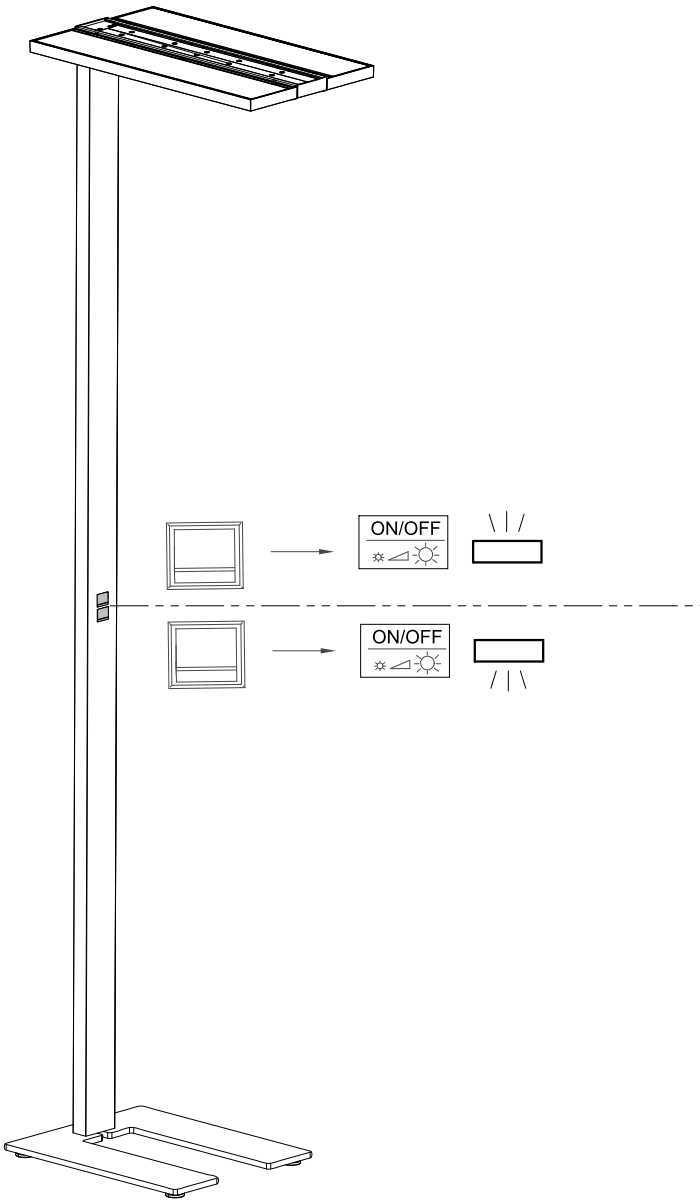

# LENSES-S...SEN

