

Technisches Datenblatt /
technical datasheet

preLink® / fixLink® Unterbaupanel
für 4 Keystone Module

Artikel Nr. / item No. : CKVPL0041E (RAL7035) / CKVPL0042E (RAL 9005)

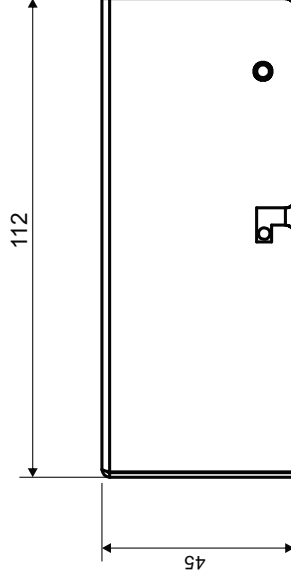
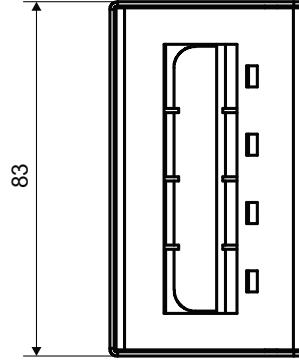

Ausschnittmaße /
Gap size

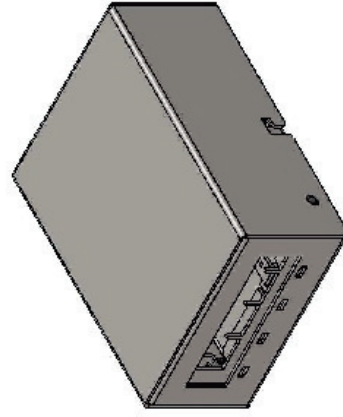
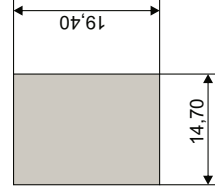

Material / material	Stahl verzinkt / steel zinc plated
Oberfläche / surface	pulverbeschichtet / powder-coated

		Maß / Dimensions: mm Original: DIN A3 Blatt / sheet 1 von / of 4	
gez. / drawn	24.03.2016	KA	preLink® / fixLink® Unterbaupanel für 4 Keystone Module Artikelnummer / article number: ZN-BL 161024
gepr. / appr.	24.03.2016	MJ	
Titel / title: preLink® / fixLink® Unterbaupanel für 4 Keystone Module Artikelnummer / article number: ZN-BL 161024		KA Name/ name	24.03.2016 Datum/ date
A Änd. rev. index	A Änderung/ revision code	KA Name/ name	24.03.2016 Datum/ date

Technisches Datenblatt /
technical datasheet

preLink® / fixLink® Unterbaupanel
für 6 Keystone Module

Artikel Nr. / item No. : CKVPL0061E (RAL7035) / CKVPL0062E (RAL 9005)

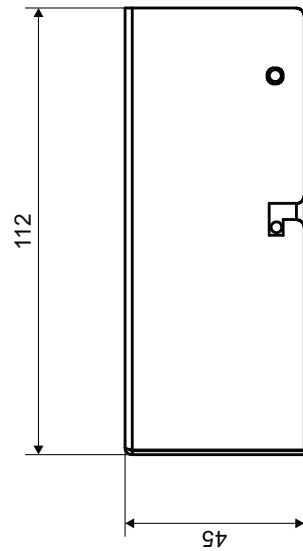
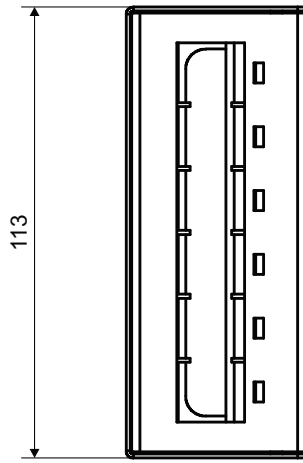

Ausschnittmaße /
Gap size

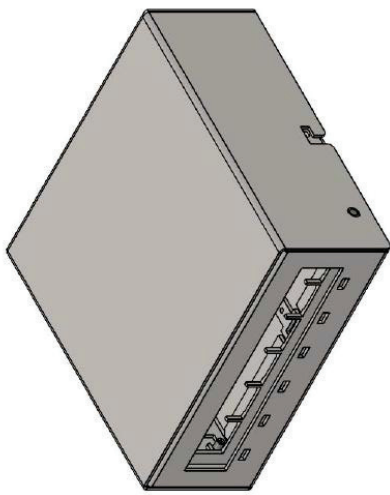
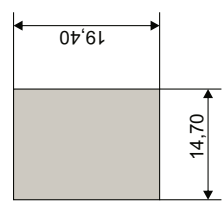

Material / material	Stahl verzinkt / steel zinc plated
Oberfläche / surface	pulverbeschichtet / powder-coated

		Maß / Dimensions: mm Original: DIN A3 Blatt / sheet 2 von / of 4	
gez. / drawn	24.03.2016	KA	preLink® / fixLink® Unterbaupanel für 6 Keystone Module Artikelnummer / article number: ZN-BL 161024
gepr. / appr.	24.03.2016	MJ	
Titel / title: Änderung / revision index: A Neuausstellung / date: 24.03.2016 Name / name: KA			

Technisches Datenblatt /
technical datasheet

preLink® / fixLink® Unterbaupanel
für 8 Keystone Module

Artikel Nr. / item No. : CKVPL0081E (RAL7035) / CKVPL0082E (RAL 9005)

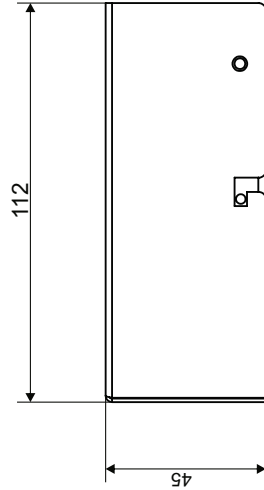
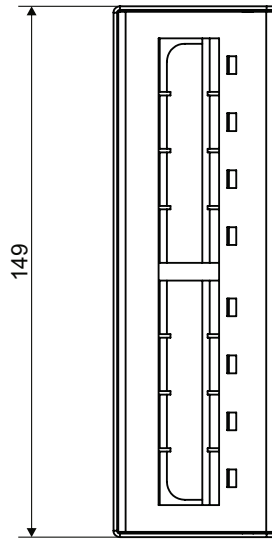

Ausschnittmaße /
Gap size

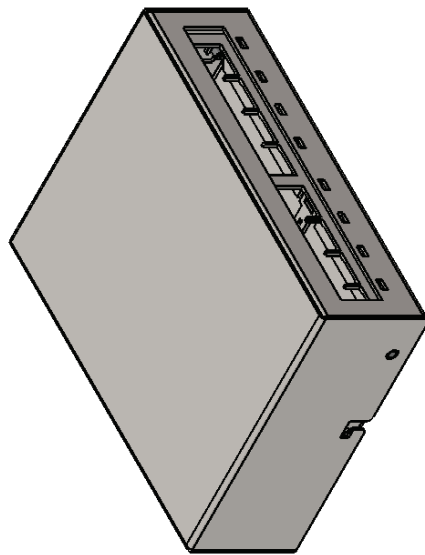
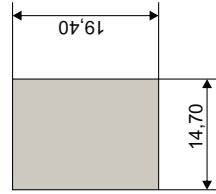

Material / material	Stahl verzinkt / steel zinc plated
Oberfläche / surface	pulverbeschichtet / powder-coated

gez. / drawn	24.03.2016	KA
gepr. / appr.	24.03.2016	MJ
Titel / title: preLink® / fixLink® Unterbaupanel für 8 Keystone Module		
Artikelnummer / article number: ZN-BL 161024		
Änd./ rev. index	Änderung/ revision code	Datum/ date
A		24.03.2016
Name/ name		KA



Maße / Dimensions: mm
Original: DIN A3
Blatt / sheet 3 von / of 4

Technisches Datenblatt /
technical datasheet

preLink® / fixLink® Unterbaupanel
für 12 Keystone Module

Artikel Nr. / item No. : CKVPL0121E (RAL7035) / CKVPL0122E (RAL 9005)

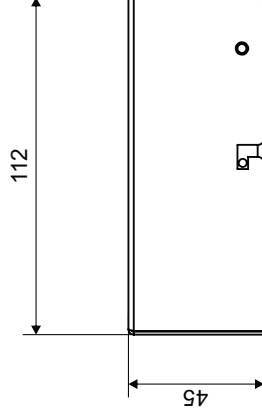
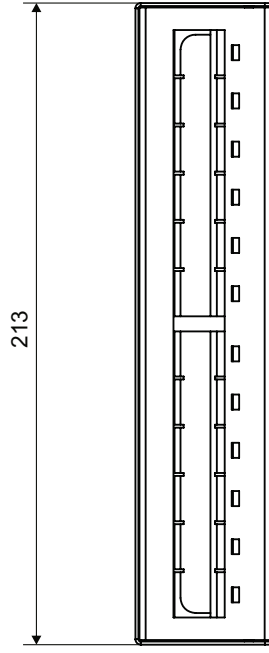

Ausschnittmaße /
Gap size

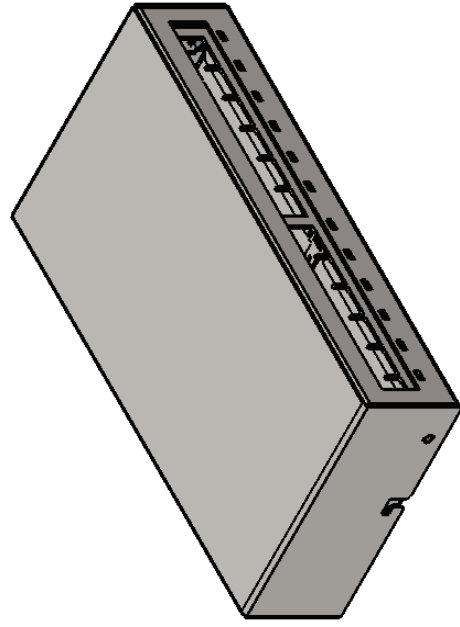
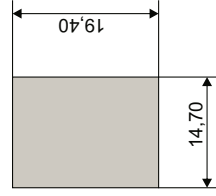

Material / material	Stahl verzinkt / steel zinc plated
Oberfläche / surface	pulverbeschichtet / powder-coated

		Maß / Dimensions: mm Original: DIN A3 Blatt / sheet 4 von / of 4	
gez. / drawn	24.03.2016	KA	
gepr. / appr.	24.03.2016	MJ	
Titel / title: preLink® / fixLink® Unterbaupanel für 12 Keystone Module			
Artikelnummer / article number: ZN-BL 161024			
A	Änderung/ rev. index	Datum/ date	Name/ name
		24.03.2016	KA