

## Montageanleitung

Ⓒ mounting instruction Ⓕ Notice de montage Ⓒ Instrukcja montażu  
Ⓔ Instrucciones de montaje ⓘ Istruzioni di montaggio

## ORTO-S

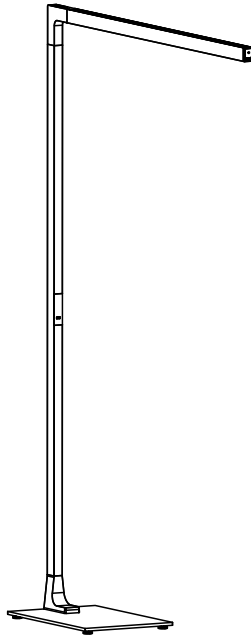

RIDI Leuchten GmbH  
Hauptstrasse 31 - 33 · D-72417Jungingen  
Tel. 07477/872-0 · Fax 07477/872-48  
kontakt@ridi.de · www.ridi.de



- Ⓓ Für die Installation und für den Betrieb der Leuchten sind die nationalen Sicherheitsvorschriften zu beachten.
- ⒼⒸ Please note national safety instructions for installation and operation of this luminaire.
- Ⓕ Pour l'installation et le fonctionnement des luminaires il est impératif de respecter les normes nationales de sécurité en vigueur.
- Ⓗ W celu prawidłowej instalacji i poprawnego działania oprawy należy przestrzegać krajowych przepisów bezpieczeństwa.
- Ⓔ Para la instalación y la puesta en funcionamiento de las luminarias deben observarse las normas nacionales de seguridad.
- Ⓘ Per l'installazione e il funzionamento delle lampade si fa riferimento alle normative di sicurezza nazionali.

- Ⓓ Die Lichtquelle dieser Leuchte ist nicht ersetzbar, wenn die Lichtquelle ihr Lebensdauerende erreicht hat, ist die gesamte Leuchte zu ersetzen.
- ⒼⒸ The light source of this luminaire is not replaceable. When light source has reached end of life-time the complete luminaire has to be replaced.
- Ⓕ La source lumineuse de ce luminaire n'est pas remplaçable. Quand la source lumineuse aura atteint la limite de sa durée de vie, le luminaire complet doit être remplacé.
- Ⓗ Nie ma możliwości wymiany źródła światła w tej oprawie oświetleniowej, po zakończeniu żywotności źródła światła, należy wymienić całą oprawę oświetleniową.
- Ⓔ La fuente lumínica de esta luminaria no se puede sustituir.
- Ⓘ Cuando la fuente lumínica ha alcanzado el final de su vida útil, hay que sustituir toda la luminaria.
- Ⓘ La sorgente di luce di questa lampada non è sostituibile, una volta esaurita la sua durata si deve sostituire l'intera lampada.

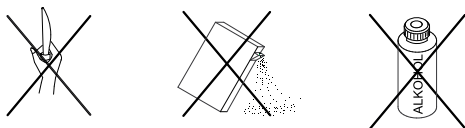
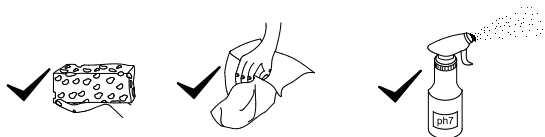

Druckfehler und Irrtum vorbehalten.  
Formelle und technische Änderungen behalten wir uns vor.

Misprints and errors excepted.  
We reserve the right of formal and technical modifications.

ORTO-S...

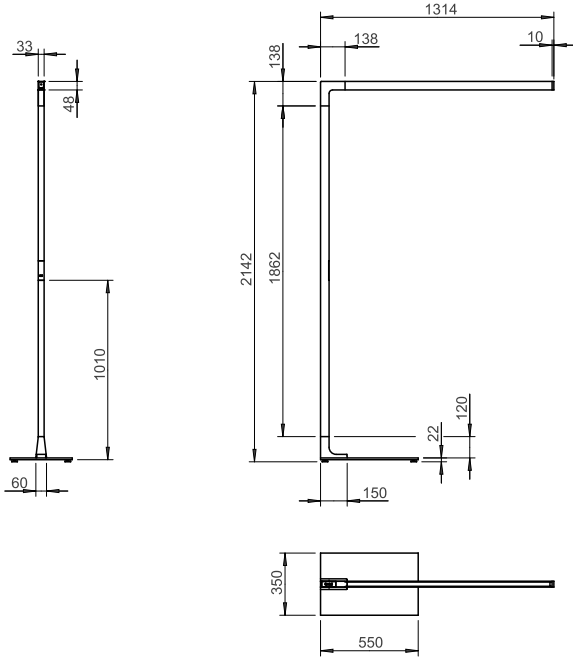
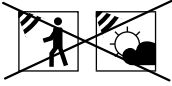

ORTO-S...SEN

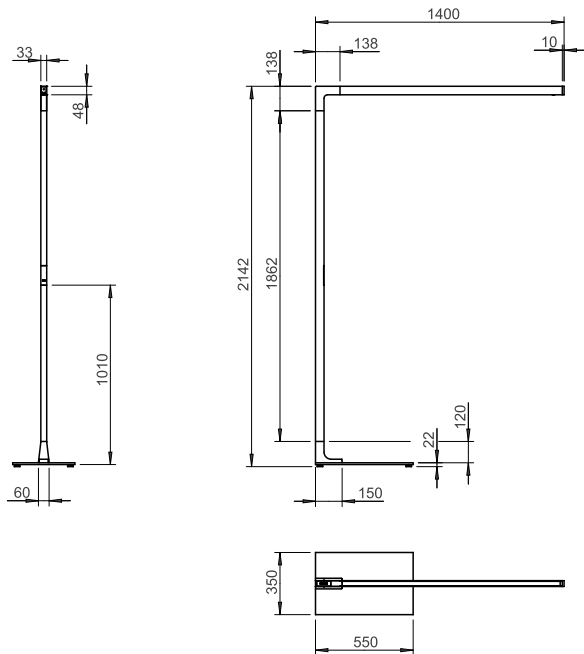

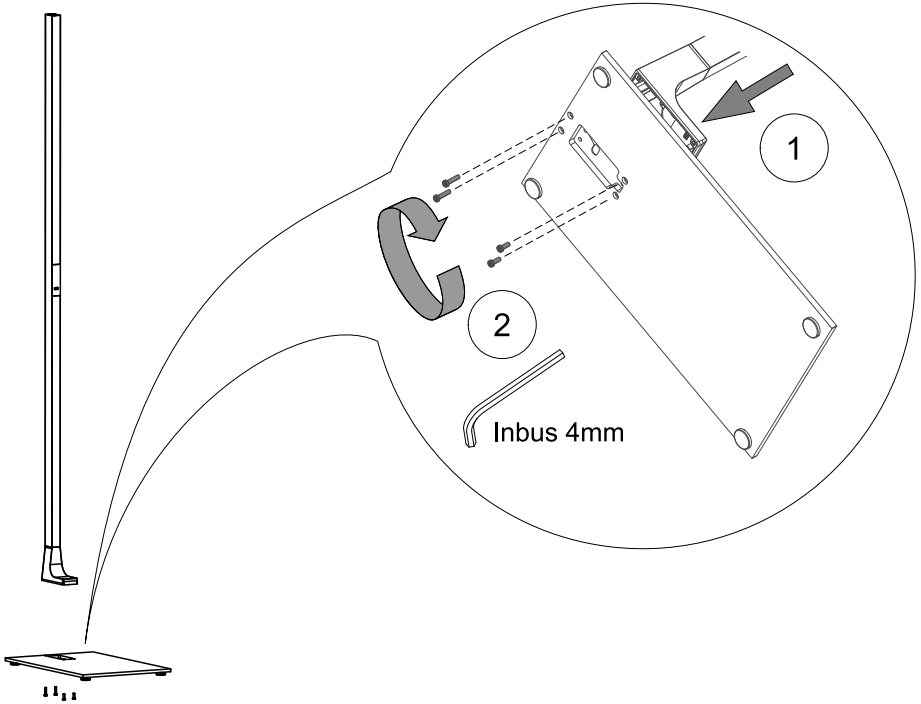
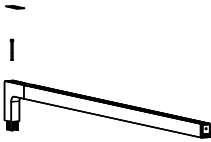
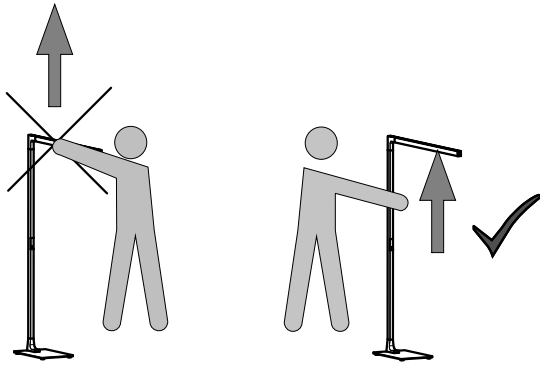

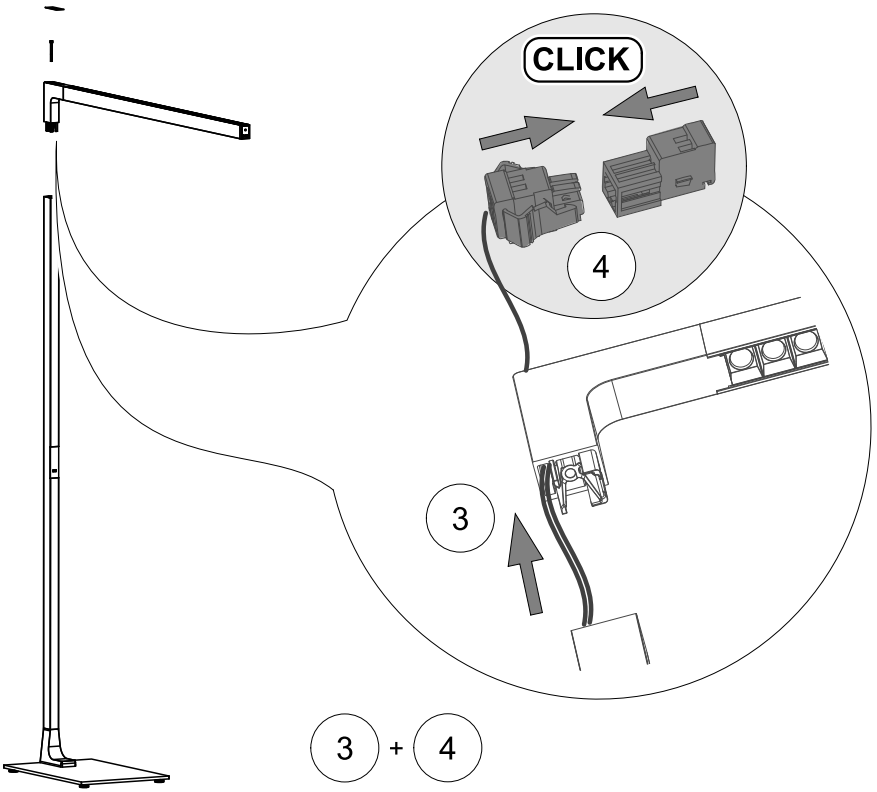

3 + 4

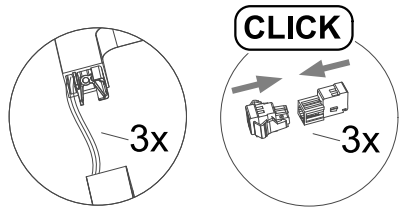
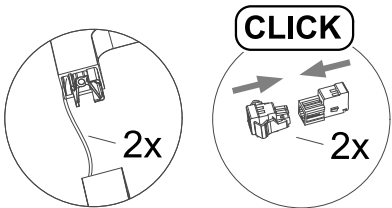
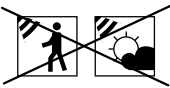
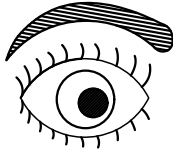

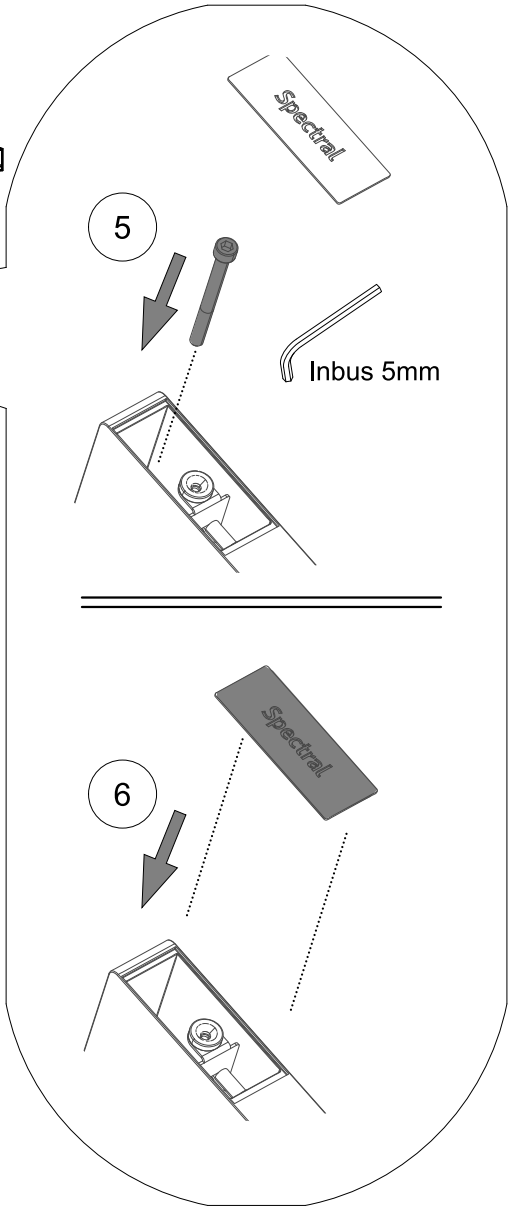
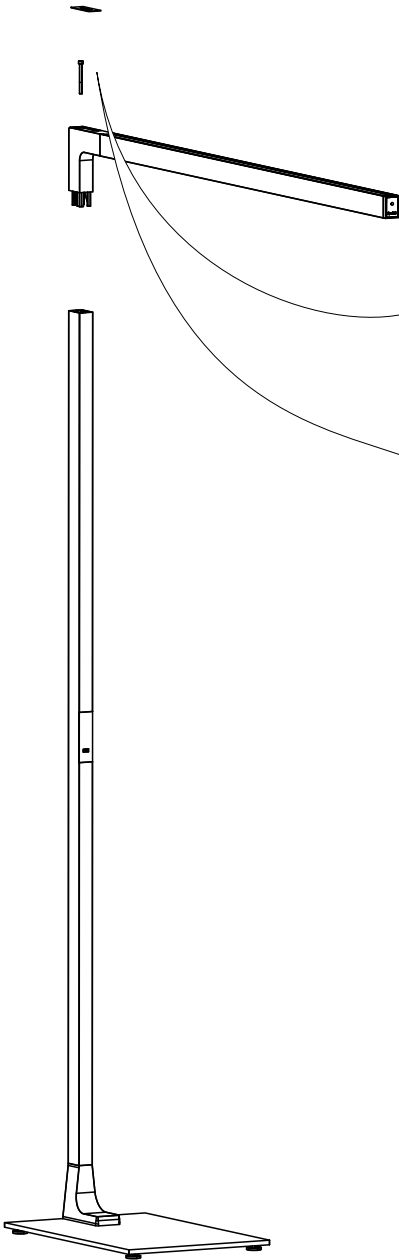

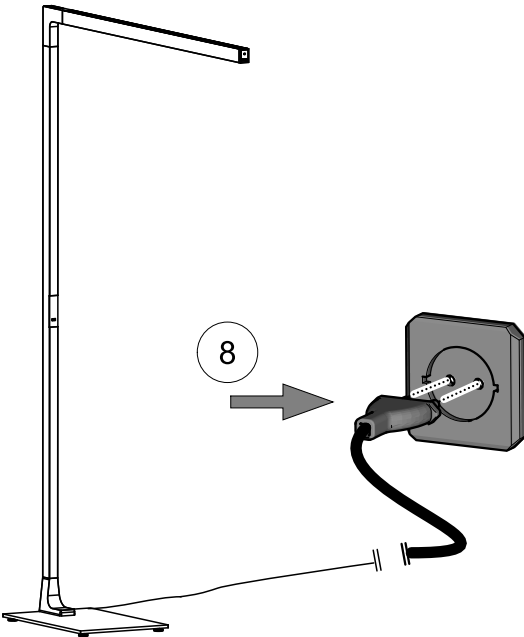
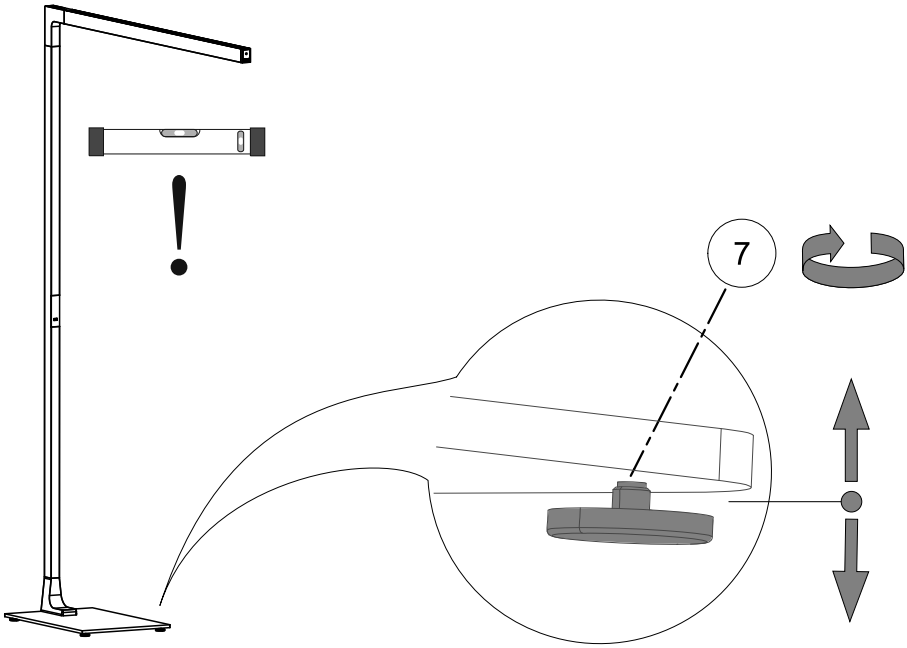

# ORTO-S...

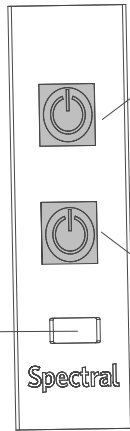
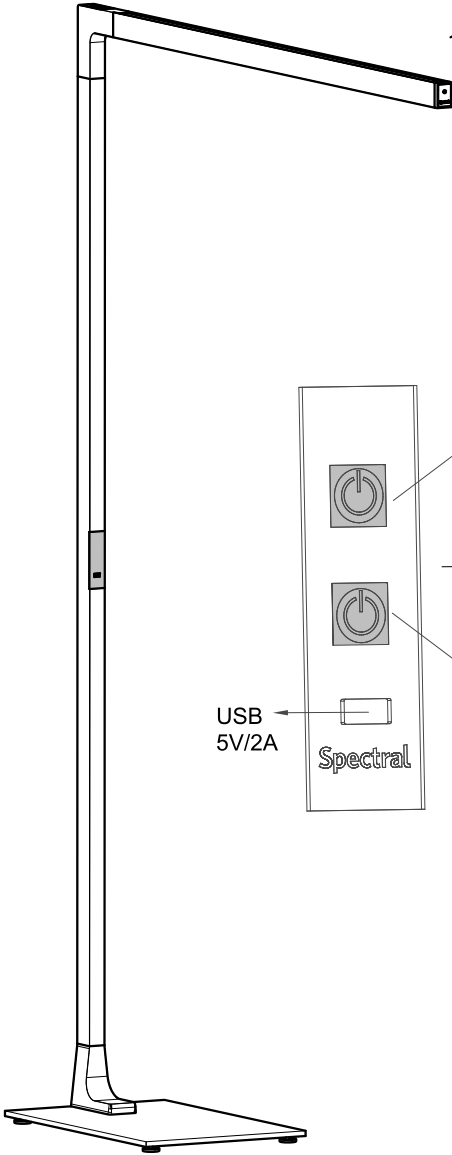
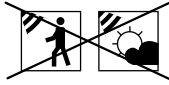

USB  
5V/2A

ON/OFF

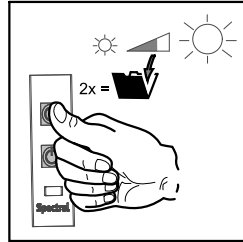

ON/OFF

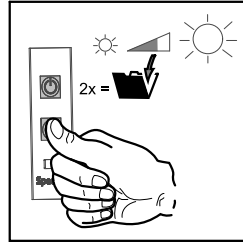



# ORTO-S...SEN

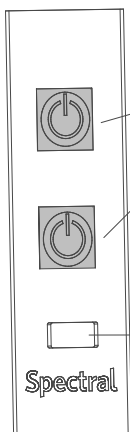
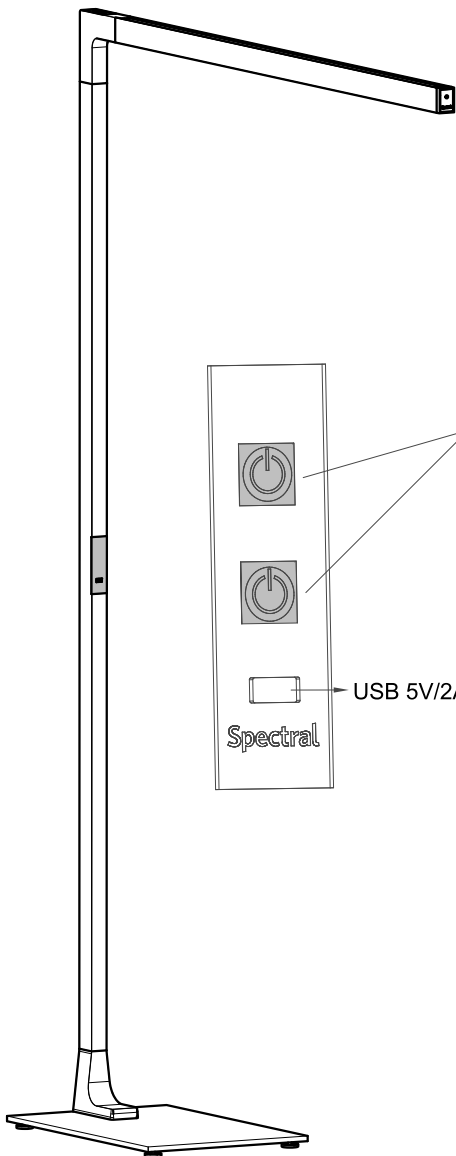

USB 5V/2A

Spectral

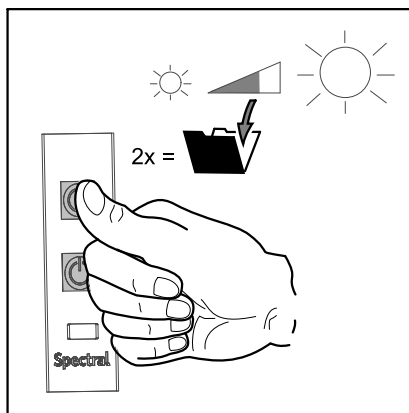
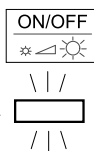

2x =

# ORTO-S...SEN

