



Downlight Performer HG

- Modernes, hochwertiges LED-Downlight
- Einzigartiges optisches Linsenkonzept mit hochglänzendem (HG) Reflektor
- Minimale Leuchtenhöhe (max 73mm)
- Direkter Ersatz für Downlights mit Kompaktleuchtstofflampen
- IP44 (Lichtaustrittsseite)
- Abdeckfolie zum Schutz vor Staub und Schmutz während der Montage



Artikeldaten

Artikelnummer	Artikelbeschreibung	Ersatz für (W)	Watt (W)	Lumen	Lichtausbeute (lm/W)	UGR	CCT (K)	CRI	Gewicht (kg/st)
140063614	LEDDownlightRc-P-HG R200-15W-BLE-4000	CFL 1x26W	15	1650	110	≤19	4000	> 80	0,84

Zubehörteile

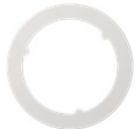

140060647
LEDDownlightRc-P-SI-E-Adapter-200-225



140061243
LEDDownlightRc-P-R200-Surface-Module-WH



549098001300
LEDDownlightRc-P EM-kit 1h



542098030700
Junction-Box-WH

140060648
LEDDownlightRc-P-SI-E-Adapter-200-250

549098001400
LEDDownlightRc-P EM-kit 3h

Produkt- und Verpackungsinformationen

Artikel			Verpackung			
Artikelnummer	Artikelbeschreibung	EU HS Code	Abmessungen (mm) (LxBxH)	Bruttogewicht (kg)	EAN	Stück/Karton
140063614	LEDDownlightRc-P-HG R200-15W-BLE-4000	94051190	260x260x118	1,21	6945730413499	1
140060647	LEDDownlightRc-P-SI-E-Adapter-200-225	94059900	250x250x0.8	0,23	6956321894139	1
140060648	LEDDownlightRc-P-SI-E-Adapter-200-250	94059900	275x275x0.8	0,20	6956321894146	1
140061243	LEDDownlightRc-P-R200-Surface-Module-WH	94059900	277x277x240	2,66	6956321841416	1
140063563	LEDSmartlight-Rc-Sensor	85365005	100x100x70	0,19	6956321862602	1
140063564	LEDSmartlight-Switch	85365005	89x21x101	0,10	6956321862619	1
506006003100	LEDSmart-Relay-500W	85364900	37x110x57	0,10	6956321820824	1
542098030700	Junction-Box-WH	85369010	43x103.4x26	0,06	6941408868684	1
549098001300	LEDDownlightRc-P EM-kit 1h	85044083	490x390x150	0,98	6941497709592	1
549098001400	LEDDownlightRc-P EM-kit 3h	85044083	490x390x150	1,08	6941497709585	1
560000005700	Smart Connect Box	85176200	100x60x105	0,30	6941497711663	1
560000008400	LEDSmartlight-Rc-MW-Sensor	85365005	110x110x75	0,19	6941497726995	1
560098000600	LEDSmart-Sensor Surface-Module-WH	94059200	330x220x255	0,15	6941497703972	1
821017001100	LEDSmart-BLE-Multi-Switch-Module	94059200	46x46x30	0,07	6941408898476	1

Technische Daten	
Lebensdauer (L70)	70.000 h
Lebensdauer (L80)	50.000 h
Ein-/aus-Zyklen	100.000
Farbbeständigkeit (SDCM)	3
Steuerbar	BLE
Abstrahlwinkel	70°
Farbe	Weiß RAL9003
IP Vorderseite	IP44
IP-Klasse rückseite	IP20
Schlagfestigkeit	IK02
Schutzklasse	II
Risikogruppe (EN 62471)	RG0 / RG1 (23W & 33W)
Mit Betriebsgerät	Ja
Glühdrahtprüfung	650°C
Leistungsfaktor	≥ 0,9

Stromversorgung	
Frequenz	50/60 Hz
Nennspannung	220-240 V
DC input voltage	Siehe Kataloganhang, Anschlußwerte und Gleichstromlichkeit (DC-fähig)
230V Kabellänge	0.3 m

Material	
Werkstoff des Gehäuses	Aluminumguss
Optisches Material	Polycarbonat

Anwendungsmöglichkeiten	
Betriebstemperatur	-10-+40°C
Anwendungstemperatur	+25°C
Lagertemperatur	-25-+50°C

5 JAHRE GARANTIE



ENERGY

OPPLE Lighting
140063614

A
B
C
D
E
F
G

E

15
kWh/1000h

2019/2015

Produktmaße (mm)

LEDDownlight Driver



LEDDownlightRc-P-HG R200

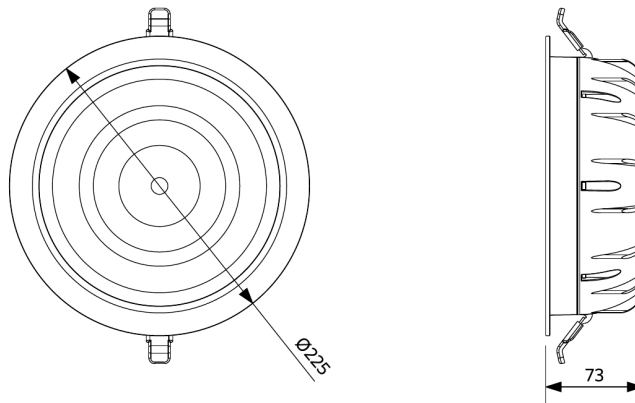

LEDDownlight Driver Tunable White



LEDDownlightRc-P-HG R200
LEDDownlightRc-P-R200-Surface-Module

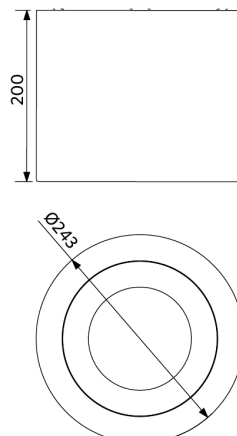

Lichttechnische Daten

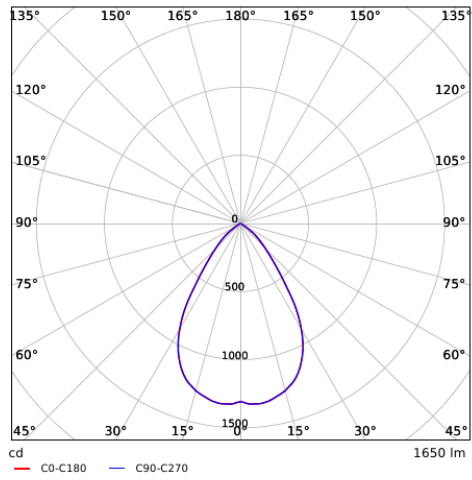

Ausschnittmaße (mm)

LEDDownlightRc-P-HG R200
Ø200

