

Accessories sockets

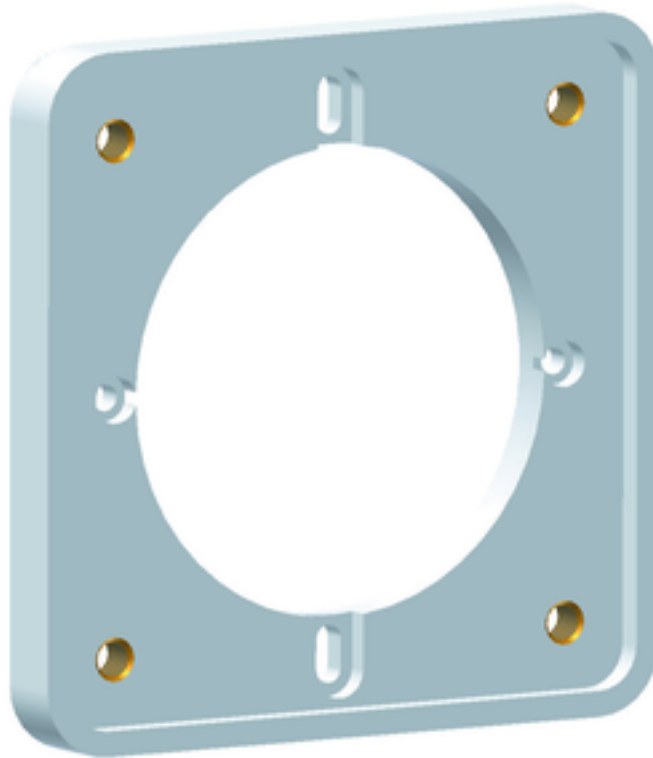

Product description	
BALS-Prd.-Nr	182
EAN	4024941001823
Product category	Intermediate flange, Intermediate flange
Colour code	grey RAL 7035, grey RAL 7035
Height	81.5mm, 81.5mm
Width	81.5mm, 81.5mm
Depth	8.5mm, 8.5mm
Material of enclosure	Polycarbonate, Polycarbonate

Additional technical properties	
	intermediate flange for panel mounting socket outlet, straight 16 and 32A, screw terminal flange size 75x75mm, intermediate flange for panel mounting socket outlet, straight 16A QUICK-CONNECT flange size 75x75mm, intermediate flange for panel mounting socket outlet, straight 16 and 32A, screw terminal flange size 75x75mm, intermediate flange for panel mounting socket outlet, straight 16A QUICK-CONNECT flange size 75x75mm

Logistics data	
Weight/pcs	0.035 kg / Piece
Packaging	Bag
Content amount	1 ST
EAN	4024941001823
Length	8.5 mm
Width	81.5 mm
Height	81.5 mm
Weight	0.036 kg
Volume	56.459 ccm
Packaging	Carton
Content amount	10 ST
EAN	4024941827812
Length	205 mm
Width	102 mm
Height	134 mm
Weight	0.41 kg

Logistics data

Volume

2,118.48 ccm

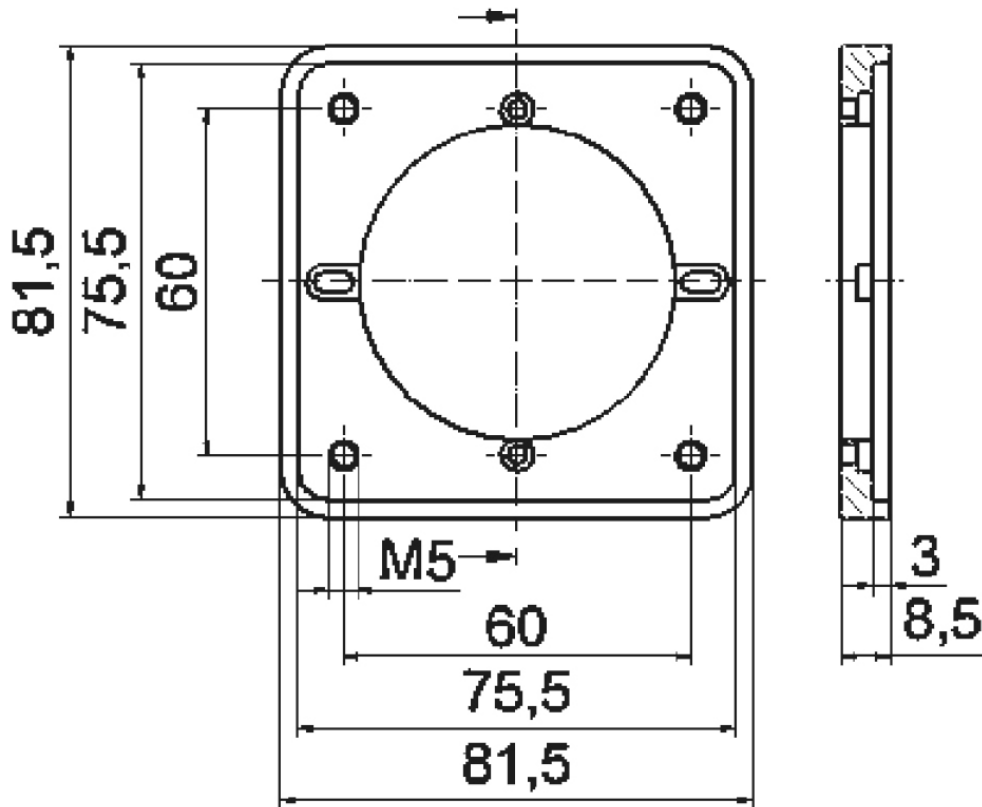

4 MB 256