

panel mounting appliance inlet - without hinged cover



Product description	
BALS-Prd.-Nr	261
EAN	4024941002615
Product category	Surface mounting appliance inlet
Current	16A
Number of poles	3p
Arrangement of phases	2P+PE
Position of earth contact	6 h
Voltage	200 - 250V~
Frequency	50/60Hz

Product description	
Protection degree	IP44
Colour code	blue RAL 5015
Colour of appliance	Enclosure grey RAL 7035, Collar blue RAL 5015
Connection design	with screw terminal
Maximum conductor size	2,5 qmm
Cable entry	other
Height	126mm
Width	74mm
Depth	71mm
Flange size vertical in mm	84mm
Flange size horizontal in mm	74mm
Drill hole dist. vertical mm	64mm
Drill hole dist. horizontal mm	58mm
Material of enclosure	Polyamide
Contacts	The contacts are brass, The contact carrier is made of polyamide

Logistics data	
Weight/pcs	0.14 kg / Piece
Packaging	Bag
Content amount	1 ST
EAN	4024941002615

Logistics data	
Length	71 mm
Width	74 mm
Height	126 mm
Weight	0.141 kg
Volume	662.004 ccm
Packaging	Carton
Content amount	10 ST
EAN	4024941965712
Length	245 mm
Width	177 mm
Height	185 mm
Weight	1.533 kg
Volume	7,140 ccm

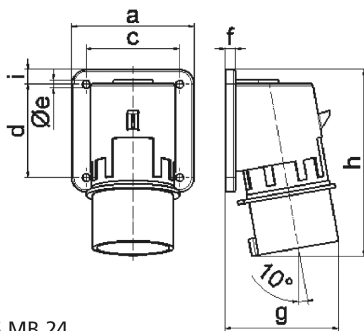

5 MB 24

Ampere	16	16	16	32	32	32
Polzahl	3	4	5	3	4	5
a	74,0	75,0	84,0	90,0	90,0	90,0
b	84,0	100,0	84,0	75,0	75,0	75,0
c	58,0	62,0	64,0	78,0	78,0	78,0
d	64,0	74,0	64,0	45,0	45,0	45,0
e ø	5,5	4,3	5,5	5,5	5,5	5,5
f	12,0	12,0	7,0	7,0	7,0	7,0
g	70,0	77,0	78,0	86,0	86,0	88,0
h	128,0	145,0	129,0	138,0	138,0	140,0
i	-	-	-	13,0	13,0	13,0
Leiter mm ² min	1	1	1	2,5	2,5	2,5
Leiter mm ² max	2,5	2,5	2,5	6	6	6