

connector - with TE screw terminals, for harsh applications



Product description	
BALS-Prd.-Nr	3185
EAN	4024941031851
Product category	TE connector
Current	63A
Number of poles	4p
Arrangement of phases	3P+PE
Position of earth contact	6 h
Voltage	380 - 415V~

Product description	
Frequency	50/60Hz
Protection degree	IP67
Colour code	red RAL 3000
Colour of appliance	Hinged lid red RAL 3000, Collar red RAL 3000, Pusher black RAL 9005, Housing cover dark grey RAL 7012, Cable gland dark grey RAL 7012, Bajonet ring dark grey RAL 7012
Connection design	screw terminal as box terminal with Kontex-contact
Maximum conductor size	16,0 qmm
Cable entry	with cable gland
Height	251mm
Width	110mm
Depth	115mm
Material of enclosure	Polyamide
Contacts	The contact carrier is made of high temperature resistant material, the contacts are brass nickel plated

Additional technical properties	
	For cable diameter from 16 up to max. 36 mm, Screwless housing connection, Multi-Grip cable gland with gasket and integrated strain relief

Logistics data	
Weight/pcs	0.72 kg / Piece
Packaging	Bag

Logistics data	
Content amount	1 ST
EAN	4024941031851
Length	115 mm
Width	110 mm
Height	251 mm
Weight	0.721 kg
Volume	3,175.15 ccm
Packaging	Carton
Content amount	5 ST
EAN	4024941946315
Length	325 mm
Width	217 mm
Height	210 mm
Weight	3.806 kg
Volume	13,588.4 ccm

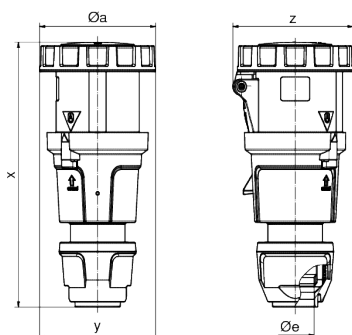

	63	63	63
Ampere	3	4	5
Polzahl	3	4	5
ø a	111,0	111,0	111,0
ø e	36,0	36,0	36,0
x	250,0	250,0	250,0
y	111,0	111,0	111,0
z	115,0	115,0	115,0
Cond. mm² min	6,0	6,0	6,0
Cond. mm² max	16,0	16,0	16,0



