

wall mounting socket outlet - housing dimensions

260x160



Product description	
BALS-Prd.-Nr	11440
EAN	4024941114400
Product category	Wall mounting socket outlet
Current	125A
Number of poles	4p
Arrangement of phases	3P+PE
Position of earth contact	9 h
Voltage	200 - 250V~

Product description	
Frequency	50/60Hz
Protection degree	IP67
Colour code	blue RAL 5015
Colour of appliance	Hinged lid blue RAL 5015, Housing bottom grey RAL 7035, Housing top grey RAL 7035, Housing screws grey RAL 7035, Bayonet ring grey RAL 7035
Connection design	screw terminal as box terminal with Kontex-contact
Maximum conductor size	70 mm ² (possible limitation by the used cable entry)
Cable entry	1xM50 from above
Height	332mm
Width	160mm
Depth	168mm
Dimension of enclosure	260x160 mm (HxW)
Material of enclosure	Polycarbonate
Contacts	The contact carrier is made of high temperature resistant material, the contacts are brass nickel plated

Additional technical properties	
	The cable entry is one at top open

Logistics data	
Weight/pcs	1.98 kg / Piece
Packaging	Carton

Logistics data	
Content amount	1 ST
EAN	4024941114400
Length	440 mm
Width	225 mm
Height	165 mm
Weight	2.208 kg
Volume	13,545 ccm

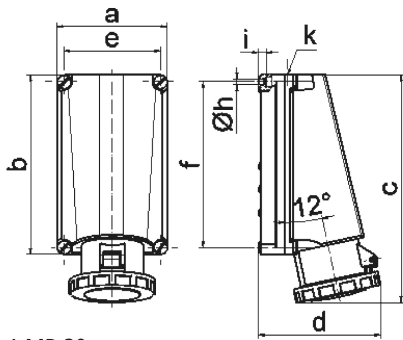

1 MB 20

Ampere Polzahl	125 3	125 4	125 5			
a	160,0	160,0	160,0			
b	260,0	260,0	260,0			
c	330,0	330,0	330,0			
d	168,0	168,0	168,0			
e	140,0	140,0	140,0			
f	240,0	240,0	240,0			
h ø	8,3	8,3	8,3			
i	10,0	10,0	10,0			
k	M50	M50	M50			
Leiter mm ² min	25	25	25			
Leiter mm ² max	70	70	70			