

panel mounting socket outlet, straight - flange 75x75,
fixing centers 60x60



Product description	
BALS-Prd.-Nr	13007
EAN	4024941130073
Product category	Panel mounting socket outlet, straight
Current	32A
Number of poles	3p
Arrangement of phases	2P+PE
Position of earth contact	6 h
Voltage	200 - 250V~

Product description	
Frequency	50/60Hz
Protection degree	IP44
Colour code	blue RAL 5015
Colour of appliance	Hinged lid blue RAL 5015, Enclosure grey RAL 7035
Connection design	with screw terminal
Maximum conductor size	10,0 qmm
Cable entry	other
Height	90mm
Width	75mm
Depth	99mm
Flange size vertical in mm	75mm
Flange size horizontal in mm	75mm
Drill hole dist. vertical mm	60mm
Drill hole dist. horizontal mm	60mm
Material of enclosure	Polyamide
Contacts	The contact carrier is made of polyamide, The contacts are brass

Logistics data	
Weight/pcs	0.19 kg / Piece
Packaging	Bag
Content amount	1 ST

Logistics data	
EAN	4024941130073
Length	99 mm
Width	75 mm
Height	90 mm
Weight	0.191 kg
Volume	668.25 ccm
Packaging	Carton
Content amount	10 ST
EAN	4024941840989
Length	258 mm
Width	183 mm
Height	212 mm
Weight	2.052 kg
Volume	8,750 ccm

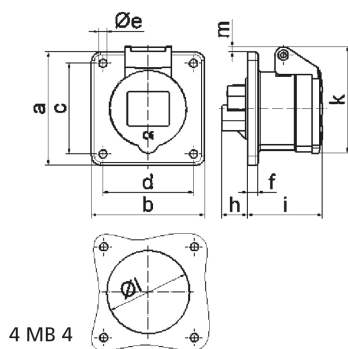

Ampere Polzahl	16 3	16 4	16 5	32 3	32 4	32 5
a	75,0	75,0	75,0	75,0	75,0	75,0
b	75,0	75,0	75,0	75,0	75,0	75,0
c	60,0	60,0	60,0	60,0	60,0	60,0
d	60,0	60,0	60,0	60,0	60,0	60,0
e ø	5,5	5,5	5,5	5,5	5,5	5,5
f	7,0	7,0	7,0	8,0	8,0	8,0
h	17,0	26,0	17,0	36,0	36,0	19,0
i	51,0	53,0	53,0	62,0	62,0	62,0
k	70,0	80,0	85,0	90,0	90,0	98,0
l ø	45,0	45,0	55,0	60,0	60,0	60,0
m	3,5	7,0	11,5	12,0	12,0	17,0
Leiter mm ² min	1,5	1,5	1,5	2,5	2,5	2,5
Leiter mm ² max	4	4	4	10	10	10