

ECG for T5 fluorescent lamps

Technical Guideline

May 2005

**Electronic Control
Gear to operate
T5/Ø 16 mm
fluorescent lamps**

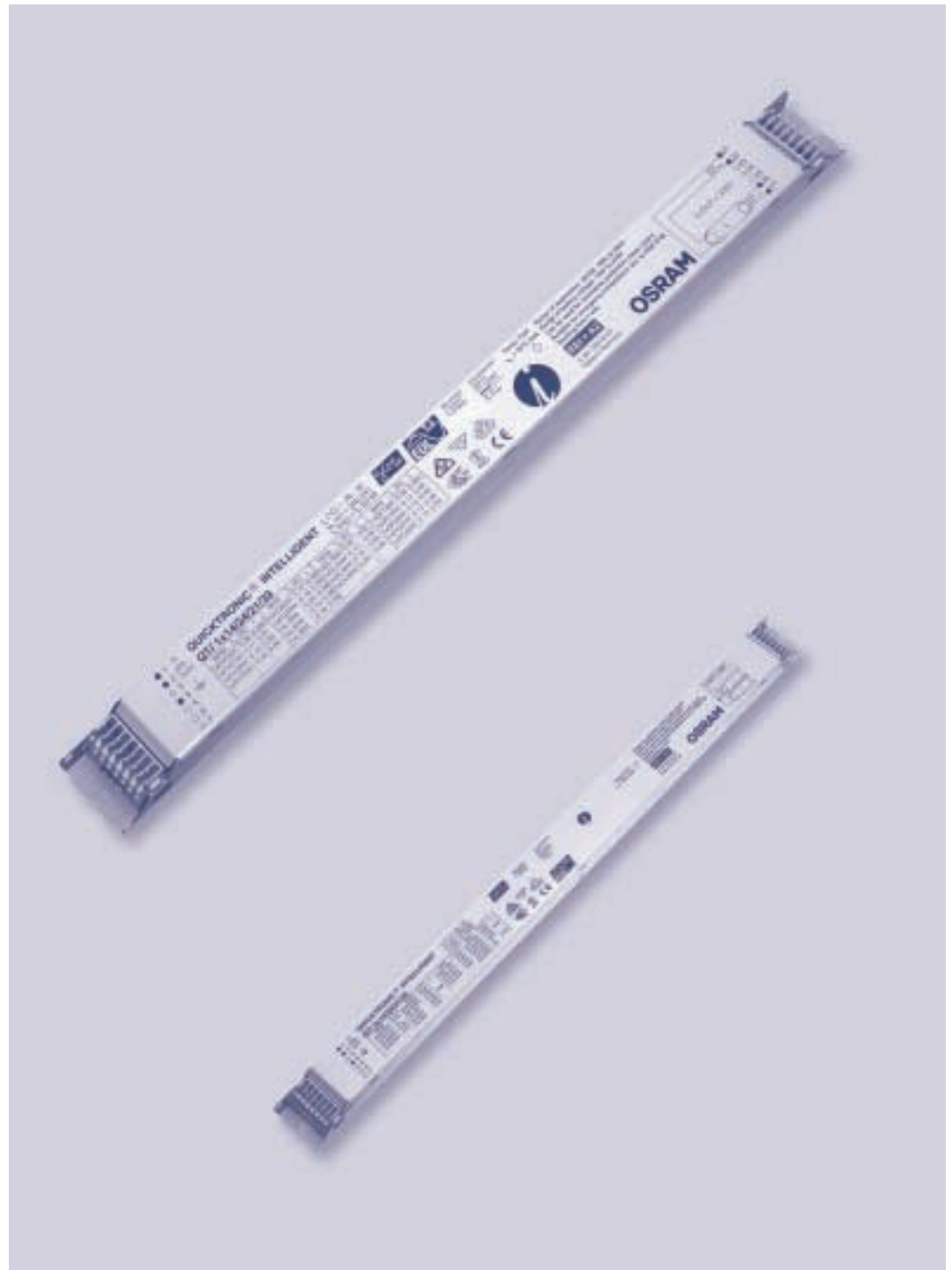

**ECG to operate
T5-fluorescent lamps
Features
Product Overview
Technical Details
Instruction Manual
Tender Documents
FAQ**

SEE THE WORLD IN A NEW LIGHT



Contents

1. Introduction	6
1.1 History	6
1.2 T5/∅ 16 mm-Fluorescent Lamps	7
1.2.1 High Efficiency FH [®] ...HE	8
1.2.2 High Output FQ [®] ...HO	8
1.2.3 Fluorescent Circular FC [®]	8
1.2.4 Comparison of Lumens between T8/∅ 26 mm- and T5/∅ 16 mm-Fluorescent Lamps	8
1.3 Electronic Control Gear	8
1.4 Different Principles, Different Behavior	9
1.5 Advantages of Electronic Control Gear	9
1.6 Saving Energy with Electronic Control Gear	9
1.7 Ignition of Fluorescent Lamps	10
1.8 Costs and Safety	10
1.9 Flexibility upon Request	10
1.10 ECG bring Progress	10
1.11 The right ECG for every Application	10
1.12 OSRAM ECG Milestones	11
2. Product Features	12
2.1 Lighting Comfort	12
2.2 Economy	12
2.3 Safety	12
2.4 Supply Voltage	13
2.4.1 Overvoltage and its Reason	13
2.4.2 Possible Implications due to Overvoltage	14
2.4.3 Undervoltage and its Reason	14
2.4.4 Possible Implications due to Undervoltage	14
2.4.5 Supply Voltage QT with 21 mm height	14
2.4.6 Supply Voltage for QT with 30 mm height	15
2.4.7 ECG for 120V / 277V Line Voltage	15
2.5 Automatic Lamp Restart	15
2.5.1 Lamp ignition for QT _i	16
2.5.2 Lamp ignition for QT to operate T5-fluorescent lamps	16
2.5.3 Off- Time for Optimum Preheat Start	16
2.6 Behaviour in Response to Lamp Defects	16
2.6.1 One-Lamp Operation with Multi-Lamp ECG	16
2.7 Noise	17
2.8 Power Factor λ	18
2.9 ECG Imprint	19
2.10 Reliability	19
2.11 Resistance to Frequent Switching	19
2.12 ECG Lifetime	19
2.13 Thermal influences of the system components	20
2.14 cut-off Technology	20
2.14.1 Advantages for Users	21
2.14.2 Physical Background	21

2.15	End of Life (EoL acc. to T.2).....	22
2.16	U-OUT	22
2.17	Approval Marks.....	23
	2.17.1 ENEC-Approval Mark	23
	2.17.1.1 Safety acc. to EN 61347	23
	2.17.1.2 Performance acc. to EN 60929.....	23
	2.17.2 VDE EMC mark	23
2.18	Energie Efficiency Index EEI	24
2.19	CE Labelling	24
2.20	CCC Approval.....	25
3. ECG installed in Luminaire: Installations and Operation		
Instructions 26		
3.1	Wiring Instructions	26
	3.1.1 Cable Types.....	26
	3.1.2 Cable Cross-Sections.....	26
	3.1.2.1 ECG in 30 mm height.....	27
	3.1.2.2 ECG in 21 mm height.....	27
	3.1.3 Release of Contacts	27
	3.1.3.1 WAGO 250.....	27
	3.1.3.2 WAGO 251 – IDC.....	27
	3.1.3.3 WAGO 251 – horizontal plug	28
	3.1.3.4 WAGO 251 mini – IDC.....	28
	3.1.3.5 WAGO 251 mini – horizontal plug.....	28
	3.1.4 Insulation	29
	3.1.5 Terminals.....	29
	3.1.6 Cable routing	29
3.2	Electromagnetic Compatibility	30
	3.2.1 Harmonic Content acc. to EN 61000-3-2.....	30
	3.2.2 Radio interference suppression	31
	3.2.2.1 Causes of Radio Interference	31
	3.2.2.2 Conducted Interferences acc. to EN 55015	31
	3.2.2.3 Disturbances due to Fields.....	32
	3.2.2.4 Selective Shielding.....	32
	3.2.2.5 Installation Instructions for avoiding Disturbance.....	33
	3.2.2.6 Asymmetric installation of ECG.....	34
	3.2.2.7 Good wiring arrangement for 2-lamp luminaires	35
	3.2.2.8 Luminaires with reflector and/or specular louvres.....	35
3.3	Permissible Cable Lengths	36
3.4	„Hot Wires“	36
3.5	Switching between Lamp and ECG	37
3.6	Master-Slave Circuit	37
	3.6.1 Max. length of the connecting cable between 2 luminaires ..	38
3.7	PE-Connection for Protection Class I Luminaires.....	38
3.8	Functional Earth for Luminaires of Protection Class II.....	39
	3.8.1 General Information	40
	3.8.2 Practical Details	40
3.9	Temperature Ranges.....	41
	3.9.1 Self heating ECG	41
	3.9.2 Control Gaer Temperatures.....	42

3.9.2.1	Measuring Point Temperature t_c	42
3.9.2.2	Ambient Temperature ECG : t_a	43
3.9.3	Lamp Temperature	43
3.9.3.1	Maximum Luminous Flux for T5/ \varnothing 16 mm-Fluorescent Lamps	43
3.9.4	General Recommendations for Installation.....	44
3.9.5	Measuring the Temperature	44
3.10	Luminaire Wiring Test for Two-lamp Luminaires	45
3.10.1	Testing with a Test Adapter and Dummy Lamps.....	45
3.11	ECG Operation for Luminaires of Protection Classes I and II48	
3.12	Insulation Distances in Luminaires	48
3.13	Insulation Test	48
3.13.1	Dielectric Resistance in Lighting Systems	49
3.13.2	Mesuring the Dielectric Resistance between N and PE or L and PE	49
3.13.3	Three-Phase Operation	50
3.13.4	Resistance to Overvoltage for QUICKTRONIC for T5/ \varnothing 16mm- Fluorescent Lamps	50
3.14	Inrush Current / Automatic Circuit Breakers	50
3.15	RCDs / Fault Currents	51
3.16	Leakage Current.....	51
3.17	ECGs in Three-Phase Operation.....	51
4.	Lamp Wiring	53
4.1	h = 21 mm.....	53
4.1.1	QUICKTRONIC® INTELLIGENT 1-lamp version	53
4.1.2	QUICKTRONIC® INTELLIGENT 2-lamp version	53
4.1.3	QT-FH MULTIWATT F/CW.....	53
4.1.4	QT-FQ F/CW 1-lamp version.....	53
4.1.5	QT-FQ F/CW 2-lamp version.....	54
4.2	h= 30 mm.....	54
4.2.1	QT-FH MULTIWATT 1- and 2-lamp version	54
4.2.2	QT-FH 3- and 4-lamp version	54
4.2.3	QT-FQ 1-lamp version	55
4.2.4	QT-FQ 2-lamp version	55
5.	QUICKTRONIC INTELLIGENT	56
5.1	Definition INTELLIGENT.....	56
5.2	Lamp Detection as Fundamental Advantage.....	56
5.3	QTi – the High-tech ECG	56
5.4	QTi – Advantages	56
5.5	QTi – Practically Applied.....	57
5.6	Technical Specialties for non-dimmable QTi	57
5.6.1	Inrush current limitation	57
5.6.2	Resistance to Overvoltage up to 400V	58
5.6.3	Lamp-ECG-Combination	58
5.6.3.1	Straight Fluorescent types	58
5.6.3.2	Compact and Circular lamp types	59
5.6.4	Wiring.....	59

























5.6.5	Dimensions	60
5.7	FAQ	60
6.	Special Applications	61
6.1	Outdoor Application	61
6.1.1	Installation Instructions	61
6.1.2	OUTKIT	62
6.2	T5-ECG in Sound Studios	62
6.2.1	Noise and how to avoid it.....	62
6.2.2	Recommended minimum distance between lamp and refelctor.....	63
6.3	Treatment Rooms, Operating Rooms.....	64
6.3.1	Electromagnetic Interference.....	64
6.3.2	Interference from Infrared Transmission Equipment	65
6.4	Electronic Tagging	65
6.5	Emergency Lighting.....	65
6.5.1	Different criteria for lighting.....	67
6.5.1.1	Switch-over time for QT _i – h=21 mm	67
6.5.1.2	Switch-over time for QT-FH...CW – h=30 mm.....	67
6.5.1.3	Switch-over time for QT-FQ...CW – h=30 mm	67
6.5.1.4	Switch-over time for QT-...F/CW – h=21 mm	67
6.5.2	Wiring diagrams for emergency lighting units.....	68
6.5.2.1	Wiring diagram QT-FH 3x14 CW with emergency lighting component from BAG	68
6.5.2.2	Wiring diagram QT-FH 4x14 CW with emergency lighting component from BAG	68
6.5.2.3	Wiring diagram QT-FH 3x14 CW with emergency lighting component from OMNITRONIX.....	69
6.5.2.4	Wiring diagram QT-FH 4x14 CW with emergency lighting component from OMNITRONIX.....	69
6.6	DC supply	69
6.7	Portable Luminaires.....	70
6.8	Mix-up of FH [®] - and FQ [®] -Fluorescent Lamps.....	70
7.	Appendix	72
7.1	Overview of Maximum Cable Lengths	72
7.1.1	QUICKTRONIC [®] INTELLIGENT.....	72
7.1.2	QT-FH MULTI...CW	72
7.1.3	QT-FQ...CW -30 mm height-	72
7.1.4	QT-FH MULTI...F/CW -21 mm height-	72
7.1.5	QT-FQ...F/CW -21 mm height-.....	73
7.1.6	QT-FC.....	73
7.2	Terminal Types	73
7.3	Inrush Currents.....	73
7.4	Lamp/ECG Combinations	74
7.5	OSRAM Installation Tips for T5-Systems	74
7.5.1	Recommended Minimum Distance between Lamp and Reflector	75
7.5.2	Recommended Minimum Distance between two T5/Ø16mm- Fluorescent Lamps	75

7.5.3	Luminaire Optimisation	76
7.5.4	Maximum luminous flux for FH...HE fluorescent lamps	76
7.5.5	Verticalness Operation	76
8.	Troubleshooting Tips	77
8.1	General	77
8.2	Equipment Behaviour on Overvoltage	77
8.3	Equipment Behaviour on Under Voltage	78
8.4	Application faults.....	78
8.4.1	Wiring faults on the lamp side.....	78
8.4.2	Short-to-ground at the output of QUICKTRONIC® ECG.....	78
8.4.3	Effects of moisture	78
8.4.4	Installing luminaires in draughty locations	78
8.5	Trouble Shooting	79
8.5.1	Lamp does not start.....	79
8.5.2	Brief Glimmer.....	80
8.5.3	Lamp goes out during operation	81
8.5.4	Different brightness levels	82
8.5.5	Fault in other electrical equipment.....	83
8.5.6	Problems at master-slave operation	83
8.5.7	Humming or “chirping” from the ECG	83
9.	Lamp-ECG Combinations	84
9.1	FQ® ...HO-Fluorescent Lamps.....	84
9.2	FH® ...HE-Fluorescent Lamps	85
9.3	FC® ...Fluorescent Lamps	85
10.	Tender Documents	87
10.1	QUICKTRONIC® INTELLIGENT QT <i>i</i>	87
10.2	QUICKTRONIC® MULTIWATT for FH...HE h = 30 mm	87
10.3	QUICKTRONIC® for FQ...HO h = 30 mm	88
11.	Index	89

1. Introduction

1.1 History

The development of linear fluorescent goes back to the thirties of the 20th century. The diameter of 51mm was very voluminous. However, better efficiency did not come up before the fifties.

1879 Kohlefaden-Glühlampe von Thomas A. Edison Incandescent lamps with carbon filament by Thomas A. Edison		1968 POWERSTAR HQI Halogen-Metaldampf lampen POWERSTAR HQI metal halide lamps		1985 OSRAM DULUX® EL Kompaktleuchtstoff- lampen mit elektronischem Vorschaltgerät OSRAM DULUX® EL energy-saving lamps with electronic control gear	
1910 Glühlampen mit Wolfram-Wendel Incandescent lamps with tungsten coils		1970 HMI METALLOGEN® Lampen HMI METALLOGEN® lamps		1987 POWERSTAR HQI-T Halogen-Metaldampf lampen POWERSTAR HQI-T compact metal halide lamps	
1925 BILUX® Zweidraht-Scheinwerferlampen BILUX® two-wire headlight lamps		1971 BILUX® H4 Halogen-Zweidraht-Scheinwerferlampen BILUX® H4 two-wire halogen headlight lamps for automobiles		1991 D1 Gasentladungslampen D1 gas discharge lamps	
1931 Natriumdampf-Niederdrucklampen Low-pressure sodium vapor lamps		1973 HALOSTAR Niedervolt-Halogenglühlampen HALOSTAR low-voltage tungsten-halogen lamps		1993 COLORSTAR DSX-T 80W Natrium-Xenonlampen COLORSTAR DSX-T 80W sodium xenon lamps	
1933 Quecksilberdampf-Hochdrucklampen High-pressure mercury vapor lamps		1979 LUMILUX® Leuchtstofflampen LUMILUX® fluorescent lamps		1993 FM Mini-Leuchtstofflampen / FM mini fluorescent lampen	
1936 Leuchtstofflampen Fluorescent lamps		1980 EVG QUICKTRONIC® DE LUXE / ECG QUICKTRONIC® DE LUXE		1995 FH Hocheffiziente Leuchtstofflampen / FH high- efficient fluorescent lamps	
1954 XBO Xenon-Hochdruck- lampen XBO high-pressure xenon lamps		1982 OSRAM DULUX® L Kompakt-Leuchtstofflampen OSRAM DULUX® L compact fluorescent lamps		1996 FQ Lichtstarke Leuchtstofflampe / FQ high power fluorescent lamps	
1968 VIALOX® NAV Standard Natriumdampf-Hochdrucklampen VIALOX® NAV Standard high-pressure sodium vapor lamps		1984 DECOSTAR Niedervolt-Halogenglühlampen mit Kathlichreflektor DECOSTAR low-voltage tungsten-halogen lamps with dichroic reflectors		1997 OSRAM ENDURA Die elektrodentlose Hochleistungsleuchtstofflampe OSRAM ENDURA The high-performance electrodeless fluorescent lamp	

The improvements according to the luminous flux and lifetime with the T12 lamp (38 mm diameter) made an economic and even outdoor application possible. There were continuous improvements for optimizations as for example Amalgamtechnology. In this term fluorescent lamps were operated by conventional control gears (CCG).

The decisive breakthrough was at the end of the 70s and early 80s. In the year 1978, a new T8/Ø 26 mm- lamp generation started to replace T12/Ø38mm- fluorescent lamps. New phosphors with higher resistance came into the market. Nowadays known under triband-phosphor (LUMILUX light colours). The diameter of the lamps was reduced from 38mm to 26mm however the length was kept with 59, 120 and 150 cm as the sockets G13. The new wattage of 18, 36 and 58 W was advantageous as it was a reduction of at least 10% compared to the T12/Ø38 mm lamps in 20, 40 and 65 W.

This was also the hour of birth for the Electronic Control Gears (ECG). First the circuits were in a instant start mode what also was called softstart up to the programmed or preheat start. Together with modern Electronic Control Gear QUICKTRONIC T8/Ø26 mm- fluorescent lamps became even more efficient and longer lasting. In addition, the thermal behavior of the luminous flux was improved.

The T8-system was permanently improved as the example of the triband-phosphor shows with a very high service life of the fluorescent lamp.

In **1995**, the next milestone of fluorescent lamp development saw the introduction of new FH...HE (**H**igh **E**fficiency) systems to the market. With the reduced diameter of 16 mm only the lamp was designed. It is available in 14, 21, 28 and 35 W with the G5 sockets. It is 50 mm shorter as the T8 fluorescent lamps.

T5 fluorescent lamps only can be operated by Electronic Control Gear. So the light output and the life time of the lamp were designed from the beginning to an optimum of up to 104 lm/W. The maximum luminous flux of the T5 lamps is at 35 °C compared to 25 °C at T8 or T12 lamps. The reduced lamp diameter of 16 mm as the maximum lumen output at 35 °C are the relevant feature for a higher efficiency of the fixture.

In **1996**, the T5 lamp family was completed with the types of higher lumens than volume FQ®...HO (**H**igh **O**utput)-fluorescent lamps. They are available in the wattage of 24, 39, 49, 54 and 80 W with the identical lengths as the FH...HE types. With up to 7000 lm for FQ 80 W HO this is the lamp family with the highest light output.

In **1999**, the third member of the T5/∅ 16 mm-lamp family was introduced to the market. Away from usual light strips, compact, efficient and unconventional luminaires benefit from this new, circular FC®-lamp: 50 % more light output than with comparable standard circular lamps.

Special Note:

Independent of the lamp diameter of the fluorescent lamp the luminous flux is specified for an ambient temperature of 25 °C. These values are exclusive to be used for light plannings. The value of the luminous flux is for the T5/∅ 16 mm fluorescent lamps FH®...HE and FQ®...HO for 25 °C below the values for 35 °C. The values at 35 °C ambient temperature are only for information. The Circular lamps FC® only have value of luminous flux at 25 °C. The advantages of the T5/∅ 16 mm fluorescent lamps show their advantages in the improved efficiency of the fixture.

Detailed technical information about QUICKTRONIC® are shown in the latest indoor outdoor lighting and can be downloaded under www.osra.de/ecg.

QUICKTRONIC® for the operation of the T5/∅ 16 mm fluorescent lamps have all features of a high quality ECG.

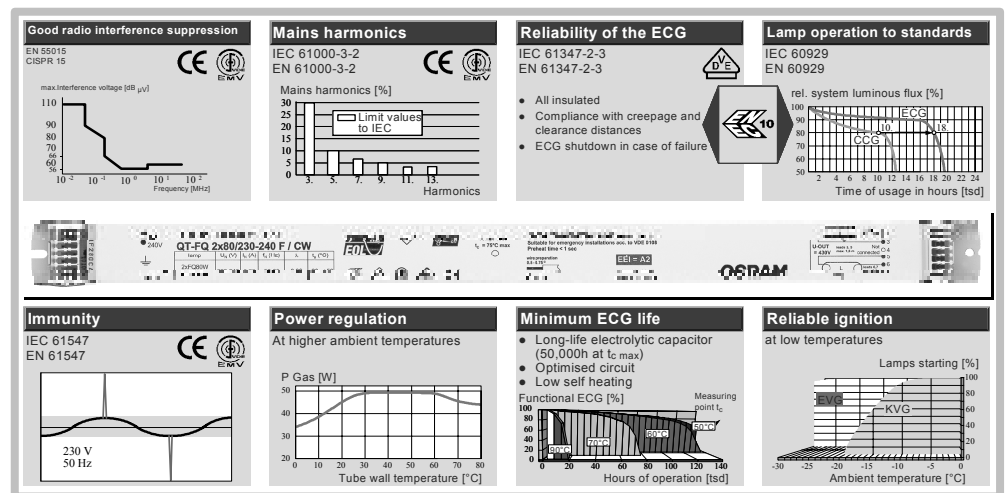

1.2 T5/∅ 16 mm-Fluorescent Lamps

The diameter and also the description of the new fluorescent lamp family is based on **American measures**: (1 inch = 25.4 mm)
 The value is combined with a T (tube).
 5/8 of an inch = 16 mm → T5-fluorescent lamp

Classification:

- T2 tube diameter of 7 mm
- T5 tube diameter of 16 mm
- T8 tube diameter of 26 mm
- T12 tube diameter of 38 mm
- T17 tube diameter of 51 mm (1936)

Consecutively the important data of the FH...HE, FQ...HO and FC fluorescent lamps are shown.

1.2.1 High Efficiency FH[®]...HE

type	length [mm]	lumens at ta=25 °C	lumens at ta=35 °C
FH [®] 14W HE	549	1200	1350
FH [®] 21W HE	849	1900	2100
FH [®] 28W HE	1149	2600	2900
FH [®] 35W HE	1449	3300	3650

Values for light colors 827, 830, 840

1.2.2 High Output FQ[®]...HO

type	length [mm]	lumens at ta=25 °C	lumens at ta=35 °C
FQ [®] 24W HO	549	1750	2000
FQ [®] 39W HO	849	3100	3500
FQ [®] 54W HO	1149	4300	4900
FQ [®] 80W HO	1449	4450	5000
FQ [®] 49W HO	1449	6150	7000

Values for light colors 827, 830, 840

1.2.3 Fluorescent Circular FC[®]

type	Ø [mm]	lumens at ta=25 °C
FC [®] 22W	225	1800
FC [®] 40W	300	3200
FC [®] 55W	300	4200

Values for light colors 827, 830, 840

Detailed technical data of T5/Ø 16 mm-fluorescent lamps can be found in the OSRAM product catalogue and under www.OSRAM.com.

1.2.4 Comparison of Lumens between T8/Ø 26 mm- and T5/Ø 16 mm- Fluorescent Lamps

Fluorescent lamp innovation: T8 → T5

T8 (Ø 26 mm)		600 mm	900 mm	1.200 mm	1.500 mm
		18 W	30 W	36 W	58 W
	Luminous flux at 25°C	1.350 lm	2.400 lm	3.350 lm	5.000 lm
T5 (Ø 16 mm)		550 mm	850 mm	1.150 mm	1.450 mm
	FH	14 W	21 W	28 W	35 W
		1.200 lm	1.900 lm	2600 lm	3.300 lm
	FQ	24 W	39 W	54 W	49 W / 80 W
		1.750 lm	3.100 lm	4.450 lm	4.300 lm / 6.150 lm
Luminous flux at 25°C					

1.3 Electronic Control Gear

Since the early seventies Electronic Control Gear have been used in computers and consumer electronics. As this technology offers substantial advantages, it was only natural to use it also for lighting purposes. Linear and compact fluorescent lamps must be operated with ballasts, as the process of gas discharge requires well defined currents and voltages. The

ballast is responsible for preheating the lamp electrodes, for sufficient ignition voltage and for limiting the lamp current.

1.4 Different Principles, Different Behavior

The basic functions that are mentioned in chapter 1.3, can usually be carried out with electromagnetic (inductive) ballasts. These ballasts are classified into conventional control gear (CCG) and low loss ballasts (LLG). The latter follow the same principle as CCG, however, due to different engineering design they consume less energy. The much better solution is to operate fluorescent lamps with Electronic Control Gear (ECG). Besides the advantages of flicker-free lighting, longer lamp life and higher system efficacy (lamp + ECG), features such as lamp ignition, limitation of the lamp current and compensation are integrated into the ECG. Most Electronic Control Gear are also suitable for DC operation, which means they can be used in emergency lighting installations.

T5/ Ø 16 mm fluorescent lamps FH®...HE, FQ®...HO and FC® can only be operated by Electronic Control Gear.

If fluorescent lamps are operated with magnetic ballasts (principle of magnetic coil, CCG and also low loss ballast), the lamp current equals the frequency of the mains voltage. The resulting stroboscopic effect can be dangerous in cases where people work with rotary machines. Every time, the voltage goes through zero, the lamp current does the same until the lamp is reignited: for every lamp ignition new carriers for the electric charge have to be build up within the gas discharge.

1.5 Advantages of Electronic Control Gear



1.6 Saving Energy with Electronic Control Gear

When using Electronic Control Gear the frequency of the lamp voltage is approx. 1000 times higher than the line voltage. The zero of the lamp current are passed so quickly that the average of the value of the electron density is nearly constant within the discharge plasma. The electrons don't have to be built up with every cycle (as it is necessary when using CCG and low loss ballasts). So the limitation of the lamp life due to reignition peaks for CCG operation are avoided with ECG operation. Therefore no stroboscopic effects can occur by using high frequency control gear as there is no longer a gap in the lamp current. Therefore, one lamp type needs less energy to generate the same lumens when operated with high frequency control gear compared to operation with magnetic ballasts. The lower energy consumption reduces the lamp load and increases the lamp

life. Electronic Control Gear improve the efficiency and the lamp life of fluorescent lamps significantly.

- 1.7 Ignition of Fluorescent Lamps** Prior to ignition, modern ECG heat the cathode to its optimum temperature for electron emission. After a defined period the lamp is ignited with the required ignition voltage. Only an optimized preheat start can guarantee that the number of switching cycles has only little effect on the lamp life. This is another important feature of ECG which has a positive effect on the cost of operation and which should not be neglected when looking for alternatives to CCG.
- 1.8 Costs and Safety** At the end of lamp life the emitter paste applied to the lamp electrode is used up. The complete loss of emitter results in an increase of voltage in the vicinity of the electrode. This situation can last over a longer period of time. As an immediate result of the accompanying temperature increase at the lamp ends the lamp sockets may overheat. Modern ECG are able to detect this malfunction and switch the lamps off. Unnecessary attempts to ignite are avoided by an interrupting function and therefore, also overheating is avoided - an important contribution to more safety. Professional ECG control all parameters constantly. A safety shut down at the end of the lamp life is mandatory from January 1st, 2007 on for all ECG that operate T4 or T5 tubes as it is included in the IEC 61347 (Omnibusnorm for safety of Electronic Control Gear). For several years now, all OSRAM QUICKTRONIC[®] fulfill the safety requirements acc. the IEC 61347 already. However as there was no Standard for this before, some ECG manufacturer neglect this due to costs.
- 1.9 Flexibility upon Request** During past years, we see a clear increase in new, better and more energy efficient lamp systems. Unfortunately, this resulted also in a growing number of various ECG-types. To reduce this large number of types manufacturers of ECG have taken a new direction and have developed new multi-purpose ECG which can be used for a variety of fluorescent lamps of different wattages. New integrated circuits allow the optimum control of lamp features such as lumen output. This type reduction has, of course, a big effect on the customer: ordering, warehousing and installation of only a few ECG-types. The so-called MULTIWATT-ECG reduce all relevant cost drivers.
- 1.10 ECG bring Progress** In addition to the basic tasks of lamp operation which are also fulfilled by magnetic ballasts, Electronic Control Gear have much more to offer: They have better performance and are more reliable, more environmental friendly and more practical than CCG; even more reasons to use professional Electronic Control Gear.
- 1.11 The right ECG for every Application** OSRAM offers the right Electronic ballast for every application as shown at the example of T8/ Ø 26 mm fluorescent lamps.

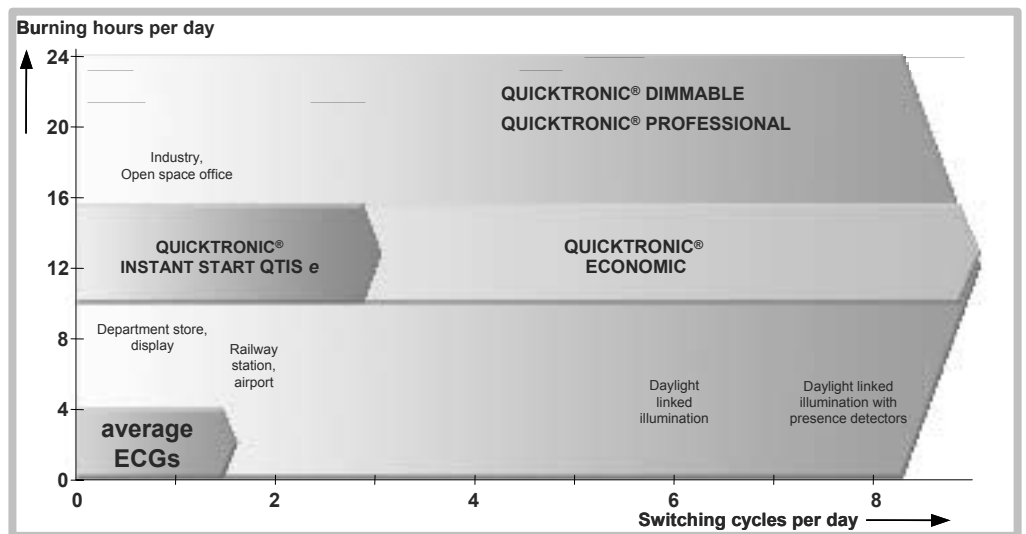



1.12 OSRAM ECG Milestones

- For the first time in **1995**, T5- fluorescent lamp systems with **Cut-off-technology** have been introduced to the market. Cut-off technology is the cut-off of the permanent filament preheating after lamp ignition. This can be realized due to modifications in the electronic circuit of the ECG. The result of the Cut-off technology are less losses and optimized lamp operation.
- Four years later, in **1999**, OSRAM sold the first reliable **MULTIWATT-ECG**. This operates all lamps with rated data.
- During the following years the trend of miniaturization continued and the height of Electronic Control Gear was reduced by 30% from 30 mm to 21 mm. In **2002**, OSRAM is again the first manufacturer to introduce **MULTIWATT-ECG to operate FQ®...HO-fluorescent lamps High Output in 21 mm height**.
- In **2003**, another novelty is brought to the T5-product segment: As the first producer, OSRAM offers a **21 mm high 2-lamp ECG** for **FQ® 80 W HO**-fluorescent lamps.
- In the beginning of **2004**, the newest and most innovative member of the T5-product family has been introduced: micro-controller based ECG capable of operating T5-fluorescent lamps of equal length regardless if it is a FH®...HE- or FQ®...HO-type. This micro-controller especially developed under the co-operation with OSRAM is responsible for clear lamp detection and lamp operation with nominal data.
QUICKTRONIC INTELLIGENT, QT_i make one MULTIWATT-ECG possible for all T5-fluorescent lamps from 14 to 39 W no matter if FH®...HE- or FQ®...HO-types.

2. Product Features

2.1 Lighting Comfort

- Flicker-free ignition
- Pleasant, flicker-free light with no stroboscopic effects due to high frequency operation
- High comfort level with no distracting choke hum due to fully electronic operation (see chapter 2.8 noise)
- No flickering
-  No flashing or flickering, electronic defective control for reliable safety switch-off of defective lamps
End-of-life safety shut down
-  Cut-off of the permanent filament preheating after lamp ignition
- Automatic restart after lamp replacement

2.2 Economy

- High lumen packages for T5 FQ[®] High Output system
- Very high luminous efficacy for T5 FH[®] High Efficiency system
- Long lamp life due to lamp start with optimum filament pre-heating and operation with cut-off technology
- Low maintenance costs due to long lamp life and reduced relamping intervals
- Lower cooling load of air-conditioning systems due to lower losses

Light engineering with T5 (Ø 16 mm) lamps

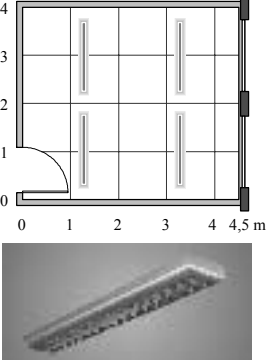
Leuchte/ Luminaire	1xL58 W	1xL58 W	1xFH35 W	Büro mit 4 1-flammigen Leuchten Office with 4 single tube luminaires 
Vorschaltgerät/ Control Gear	VVG/ LLG	EVG/ ECG	EVG/ ECG	
E [lux]	539	518	500	
P _{gesamt/total} [W]	260	220	154	
%	100 %	85 %	59 %	
W/m ²	15	12	9	

2.3 Safety

All Electronic Control Gear QUICKTRONIC[®] for operation of T5/Ø 16 mm-fluorescent lamp systems are developed and designed according to all relevant national and international industry standards. Current standard is EN 61347. For Electronic Control Gear for operation of low pressure gas discharge lamps EN 61347-2-3 applies.

In detail:

-  Safe shutdown of the power supply to defective lamps or at the end-of-life due to **End-of-Life** detection according to **Test 2** Shutdown in the event of broken filaments, no inserted lamp or air leakage
- Compliance with European safety standards (EN 61347-2-3)
- Protection against short duration voltage surges (DIN VDE 0160) and transient overvoltages
- Low housing temperatures allow the mechanical design of lighting fittings with F- and FF- as well as M- and MM-approval mark (EN 60598/DIN VDE 0710 and DIN VDE 0711)
- Can be used in emergency lighting systems according to DIN VDE 0108

2.4 Supply Voltage

Electronic Control Gear QUICKTRONIC® for T5/Ø 16 mm-fluorescent lamps (FH®...HE, FQ®...HO and FC®) can be operated on sinusoidal AC voltage and DC voltage. The recommended voltage intervals depend on the design of the specific circuits.

The following chapters show the recommended voltage ranges and the behaviour of the ECG at overvoltage and undervoltage.

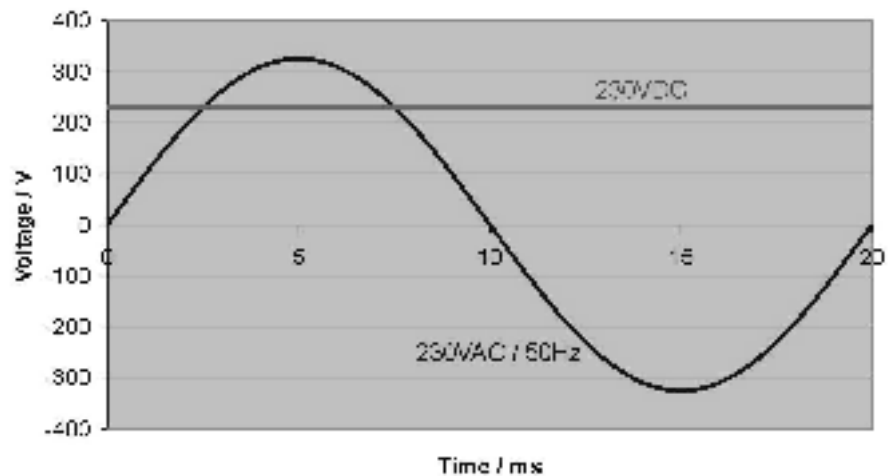

2.4.1 Overvoltage and its Reason

It is called an overvoltage if the ingoing voltage is significantly higher than the nominal value.

In general, we have to differentiate between two overvoltages which also can have different reasons.

1. Transient overvoltage with a typical duration of milliseconds.
This overvoltage can be caused by:
 - Switching of inductive loads such as welding machines, elevators alternators etc.
 - lightning

Quasi-stationary overvoltage with a duration from a few minutes to hours.
This overvoltage can be caused by:

- different loads on the mains side (interruption of the neutral conductor in 3-phase installations plus an additional asymmetric

- load distribution)
- unstable power supply (for example some countries in Far East)

2.4.2 Possible Implications due to Overvoltage

It is called overvoltage, if the supply voltage exceeds the specified voltage range of an ECG including tolerances.

In any case, overload means more stress to electronic components. Depending on the magnitude of overvoltage the protective functions of an ECG can come into effect and turn the ballast off.

In extreme situations overvoltages can even destroy electronic components.

Therefore, please pay attention to the design of the mains and tolerances of the Electronic Control Gear when using them.

2.4.3 Undervoltage and its Reason

Supply voltages can not only deviate to higher values but also to lower values. If the supply voltage decreases below the value specified in the technical data of an ECG, we have to deal with undervoltage.

This may be true for the following points:

- Different loads on the mains side
- Incorrect electric installation
- Unstable power supply
- In some cases when used with emergency generators

2.4.4 Possible Implications due to Undervoltage

Operating ECG with undervoltage is not as specified. This may result in the following implications:

- Lamp operation not according to standards → affecting lamp life
- No safe lamp start, a safe ignition is only guaranteed above supply voltages of 198 V
- Unstable lamp operation meaning the discharge process of a fluorescent lamp is not stable
- In order to keep the lamp wattage constant most ECG types are controlled on the lamp side. In this case, reduced supply voltages cause much higher currents which may lead to physical stress of components and to failure of the entire ECG. If supply voltages deviate significantly from the nominal values, high switching losses and overload of transistors can occur finally causing ballast failures.

2.4.5 Supply Voltage QT with 21 mm height

Valid for: QT_i and QT...F/CW	
Recommended voltage range for continuous operation	
AC voltage	198 V ... 264 V, 50/60 Hz
DC voltage	176 V ... 264 V
Performance at undervoltage	
Lamp ignition	$U_N \geq 198 \text{ V} \rightarrow$ reliable lamp ignition
Voltage drop during operation	$U_N \geq 176 \text{ V} \rightarrow$ operation possible $U_N < 176 \text{ V} \rightarrow$ damage to ECG possible

2.4.6 Supply Voltage for QT with 30 mm height

Valid for: QT-FH MULTIWATT and QT-FQ	
Recommended voltage range for continuous operation	
AC voltage	198V ... 264V, 50/60 Hz
DC voltage	176V ... 264V
Performance at undervoltage	
Lamp ignition	$U_N \geq 198V \rightarrow$ reliable lamp start
Voltage drop during operation	$U_N \geq 176V \rightarrow$ operation possible $U_N < 176V \rightarrow$ damage to ECG possible

2.4.7 ECG for 120V / 277V Line Voltage

T5/Ø 16 mm fluorescent lamps are also getting more popular in North America (USA, Canada). Historically in the US-market have been established lamps in 4 ft length besides the types of 240 cm. 4 ft is also known as 48 inch type (1 ft = 30.48 cm) and is acc. to our typical 120 cm types. Related to the straight fluorescent types FH[®]...HE and FQ[®]...HO this means 1,149 mm for FH[®] 28 W HE and FQ[®] 54 W HO.

OSRAM SYLVANIA offers the complete range for FH[®]...HE and FQ[®]...HO under PENTRON ECG. The specification there is PENTRON High Performance T5 lamps for FH[®] and PENTRON High Output T5 for FQ[®] lamps.

OSRAM SYLVANIA also offers the ECG for the North American line voltages 120 V / 277 V und 60 Hz line frequency as shown at a glance:

MULTIWATT ECG for FH[®] fluorescent lamps: 14, 21, 28 and 35 W HE
Types: QTP 1x28T5/UNV PSN suitable for 120-277 V
QTP 2x28T5/UNV PSN suitable for 120-277 V

ECG to operate FQ[®] 54 W HO
Types: QTP 1x54T5UNV/PSN suitable for 120-277 V
QTP 2x54T5UNV/PSN suitable for 120-277 V

For a large number of differnt lamp types including T8 OCTRON a variety of dimmable and non dimmable types is available.

Information about availability under:

OSRAM LIGHT CONSULTING (OLC)
Hellabrunner Straße 1
81536 München

Tel: +49-89-6213 3076 Fax: +49-89-6213 2020

2.5 Automatic Lamp Restart

With all QUICKTRONIC[®] for operation of T5/Ø 16 mm-fluorescent lamps FH[®]...HE, FQ[®]...HO and FC[®], automatic restart takes place after a change of lamp provided the power supply is maintained.

Should in the case of a twin-lamp ECG no automatic lamp restart take place after lamp replacement and could an ECG-failure be excluded, please proceed as follows:

Replace both lamps, take out the lamp replaced first and refit it. Provided lamp and ECG are o.k. both lamps should then light.

2.5.1 Lamp ignition for QT_i

Lamp start	Preheat
Ignition time	< 1 second
Max. number of switching cycles	> 100,000 cycles

2.5.2 Lamp ignition for QT to operate T5-fluorescent lamps

QT-FH MULTI, QT-FQ, QT...F/CW	
Lamp start	Preheat
Ignition time	< 0.5 second
Max. number of switching cycles	> 100,000 cycles

2.5.3 Off- Time for Optimum Preheat Start

All QUICKTRONIC to operate T5/Ø 16 mm- fluorescent lamps FH[®]...HE, FQ[®]...HO and FC start the lamps at any time with optimum preheat start even after a turn-off followed by an immediate lamp restart. OSRAM QUICKTRONIC ignite the lamp always with optimum preheating of the electrodes. A particular off-time with regards to lamp life is not necessary.

2.6 Behaviour in Response to Lamp Defects

What do we mean by lamp defect or end-of-lamp life?

In most cases, it is not possible to see from outside which lampholders are assigned to which ECG-terminals, so if you insert lamps and they fail to start automatically you should take out the first lamp again and refit it. Both lamps should then light.

Lamp replacement of 2- and multilamp luminaires proceed as follows:

Insert the lamps. If at 2- or multilamp luminaires lamp ignition doesn't work automatically, take out the lamp replaced first and refit it. Reignition of both lamps works automatically.

2.6.1 One-Lamp Operation with Multi-Lamp ECG

What are the requirements?

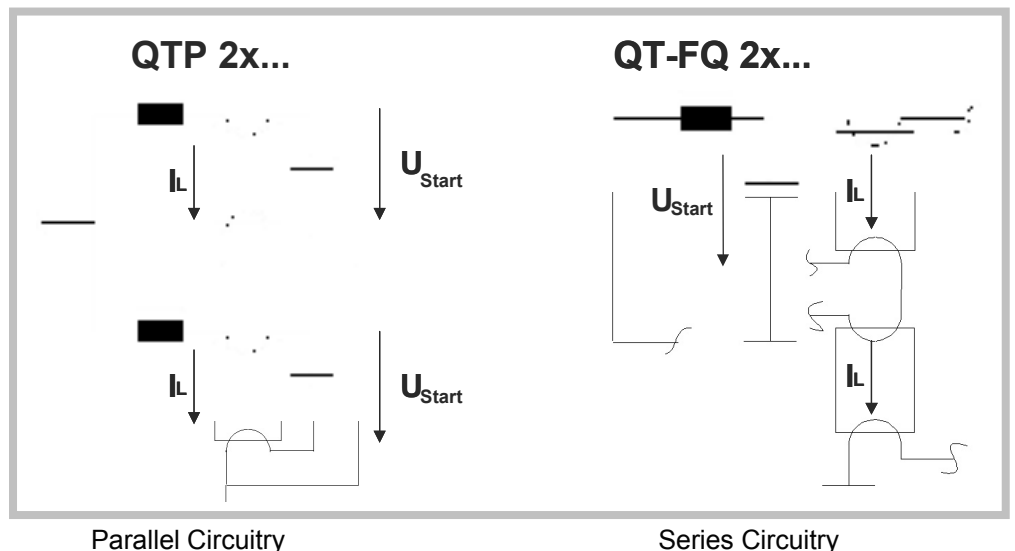

- Parallel circuit of lamps operated with multi-lamp ECG \neq in general single-lamp operation possible
- Parallel circuit of lamps, but no single-lamp operation possible because for example
 - the sum of electrodes has to be recognized

For twin- and multi-lamp ECG the question is whether the remaining lamps will continue to operate if one lamp is defect or has been removed.

In the case of twin- or multi-lamp ECG, any lamp fault that causes the safe shutdown circuit to operate will lead to the shutdown of all lamps.

This function is called "safety shutdown". The detection of various "out-of-range" parameters results in a reliable shutdown of the ECG. The ECG do not perform any lamp starts that could cause problems as described under chapter 2.3.

In this case, one lamp or the remaining lamps will therefore never continue to burn by itself.

What happens when one lamp is removed from a multi-lamp ECG will depend on the type of circuit. Series circuits always exclude a single-lamp operation. Parallel circuit is one condition for a possible single-lamp operation, however, not the only one. Another important criterion is lamp control during operation of circuit related as well as safety related data.

QUICKTRONIC® INTELLIGENT, QT_i, are carried out in parallel circuits, but cannot be operated in single-lamp mode. The reason is the sophisticated lamp detection requiring the control of various parameters.

The following table gives a short summary of the different ECG-types:

ECG-type height	QT _i 21 mm	QT-FH 30 mm	QT-FQ 30 mm	QT-FH 3x, 4x 30 mm	QT ... F/CW 21 mm
Series circuit		X	X	X	X
Parallel circuit.	X				

For all types shown in the table above a single-lamp operation is **not** possible.

2.7 Noise

T5/Ø 16 mm-fluorescent lamps FH®...HE, FQ®...HO and FC® operated at high frequency with QUICKTRONIC® control gear are virtually silent.

QUICKTRONIC® units themselves are so quiet that even in very quiet surroundings they cannot be heard by the human ear. They are therefore ideal for sound-sensitive areas such as radio and recording studios. The limit of the frequency-dependant sound pressure curve is based on the audibility threshold (in other words, a person with normal hearing will not be able to detect the noise generated by an ECG in the same room).

The factors affecting the sound pressure level are the sound power level of the ECG, the absorption properties of the room, characterised by its volume and reverberation time, and the number of ECGs.

In mains supplies with a high level of distortion in which the mains voltage wave form deviates significantly from a sine wave, a „chirping“ may be heard from the reactance coils in the input section of the ECG.

2.8 Power Factor λ

For all electric loads, the power factor λ is the ratio of effective power ($P_{\text{eff}} = \text{voltage} \times \text{effective current}$) to apparent power ($P_{\text{app}} = \text{voltage} \times \text{apparent current}$). This value is affected both by the phase displacement $\cos \varphi$ between current and voltage by the current wave form distortion ε (non-sinusoidal wave form)

$$\lambda = P_{\text{eff}} / P_{\text{app}} = \varepsilon \cos \varphi$$

In contrast to conventional control gear (CCG, inductive, 50 Hz), there is hardly any phase displacement with Electronic Control Gear (high frequency), which means that capacitor correction is not required. However slight distortions in the current sine-wave curve occur during operation of electronic control gear. In general these distortions are characterized by integer multiples of the mains frequency (harmonics).

The harmonic content of the mains current is controlled by national and international regulations (IEC 61000-3-2, EN 61000-3-2). OSRAM ECG have built-in active electronic harmonic filters for this purpose which guarantee a value for ε of more than 0.95 and hence a power factor λ greater than 0.95.

Exemptions are ECG which apply to the international standard for system power consumption less than 25 W. This standard requires a power factor λ of more than 0.6. These ECG are part of the product segment ECO and are known as QUICKTRONIC[®] ECONOMIC or QT-ECO. They are mainly used to replace conventional control gear, but because of their MULTIWATT-design they can partly operate FH[®] ...HE- and FQ[®] ...HO fluorescent lamps with lower wattages:

FH[®] 14W HE

FH[®] 21W HE

FQ[®] 24W HO

For detailed information about this combination please see www.OSRAM.de/products/ecg

With regards to their harmonics content all QUICKTRONIC[®] have been tested by VDE according to EN 61000-3-2 and carry the VDE-EMC approval mark.



The confirmation of the ECG's CE-mark by an independent testing facility reduce the costs and the time necessary for approval of luminaires significantly.



2.9 ECG Imprint

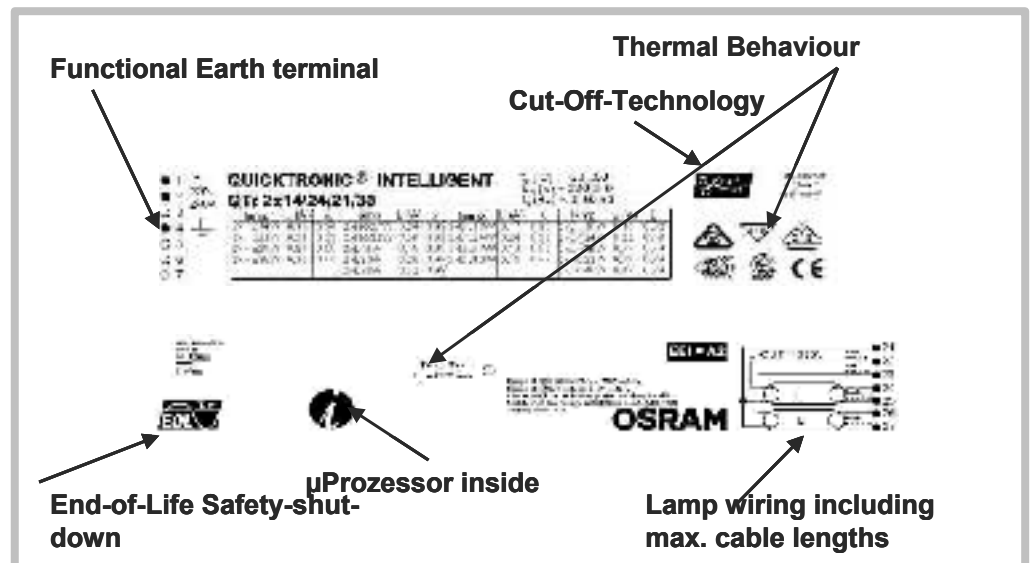

2.10 Reliability

Besides component specification and quality their failure rate is significantly related to the operating temperature.

Electronic Control Gear of OSRAM are designed in that way, that a failure rate of less than 2 Promille per 1,000 operating hours is expected if operation takes place at the maximum permitted case temperature (t_c).

2.11 Resistance to Frequent Switching

The resistance to frequent switching of Electronic control gear is based on possible lamp starts per day. Multiplied with the lamp life professional ECG with preheat start reach more than 100.000 switching cycles.

This information is important for combinations with occupancy sensors as this is one of the most popular applications for frequent switching of the lamp-ECG system.

2.12 ECG Lifetime

The ECG lifetime depends on the operating temperature and failure rate of the electronic components. Extreme overheating can destroy electronic components in a short period of time and cause the ECG to fail. There exists an exponential relationship between the failure rate of electronic components and their thermal and also electrical behaviour.

An indication about the maximum recommended ambient temperature of a luminaire is given by the imprinted measuring point t_c at which each ECG reaches its maximum recommended case temperature. The t_c -temperature of an OSRAM ECG is closely linked to its temperature of electronic components. For example, when the maximum recommended t_c -temperature of 70 °C is reached, a QUICKTRONIC control gear for operation of T5/Ø 16 mm-fluorescent lamps is expected to last 50,000 hours with a failure rate of max. 10 %. This value equals a failure rate of 2 ‰ per 1,000 operating hours. Due to the exponential dependence on temperature and failure rate of electronic components exceeding the recommended t_c -temperature reduces the ECG lifetime dramatically. On the other hand, if the ECG temperature remains below the limit the lifetime is extended. As a rule of thumb, every 10 °C below the imprinted temperature value double the ECG's lifetime and every 10 °C surpassing the t_c -value cut the service life in half.

The measuring temperature t_c is an important parameter for both the safety approval for a luminaire according to EN 60598 and the service life of an

ECG provided by the manufacturer under consideration of the thermal load of electronic components.

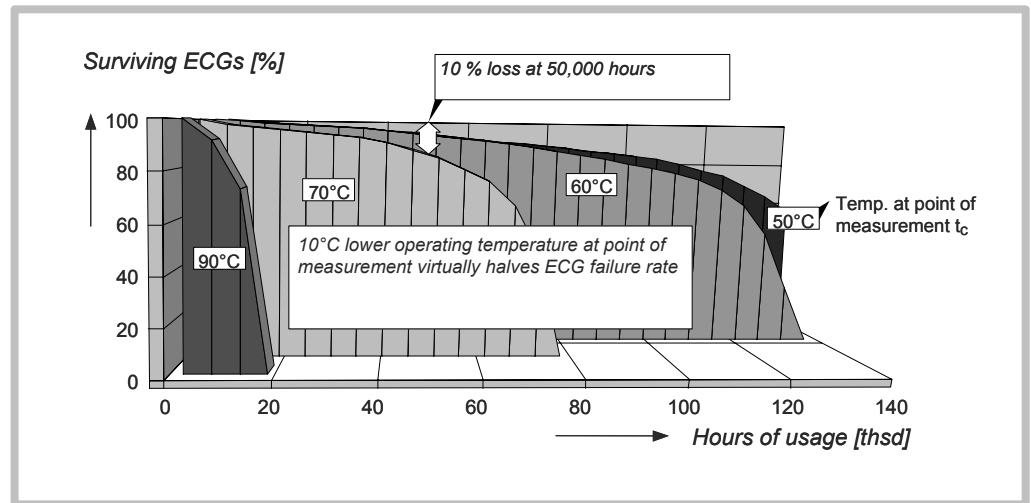

2.13 Thermal influences of the system components

The temperature must be assessed separately for the two system components (ECG and lamp). In the case of the lamp, there are physical laws that restrict the temperature range of an application, whereas in the case of the ECG fixed limits must be set in order to ensure reliable operation.

Apart from this, there are external factors such as the reciprocal influences of ECG, lamp and luminaire and the selected installation site which have an influence. Compliance with the specified limits and hence the guarantee of operational reliability are the responsibility of the relevant luminaire or system manufacturer.

There is a fixed correlation between t_c -temperature, the temperature of electronic components, the life of each component and hence the complete unit. Thermal contact of an ECG to metallic parts of luminaire housings is very positive due to good thermal conductivity.

The correlation between temperature t_c of the measuring point, component life and failure rate is crucial for an objective assessment of the reliability and service life of an ECG. Information about t_c -temperature and ECG service life alone are not sufficient.

2.14 cut-off Technology



All QUICKTRONIC® control gear for operation of T5/Ø 16 mm-fluorescent lamps FH® ...HE and FQ® ...HO are equipped with cut-off technology.

After starting the lamp the electrode heating is being switched off. Lamp life increases due to the reduced load of the electrodes. Therefore, cut-off technology increases the lumen output of the luminaire and the lamp life. And for the first time, cut-off technology is included in dimmable ECG thanks to the new intelligent technology of QT_i. Compared to Electronic control gear without cut-off the power consumption of ECG with cut-off technology could be reduced by another 5 to 7 %.

2.14.1 Advantages for Users

The following advantages for users arise from cut-off technology:

- 6-10 % higher luminaire efficiency
- highest lamp life
- 2-3 W lower losses per lamp
- reduced load of air condition

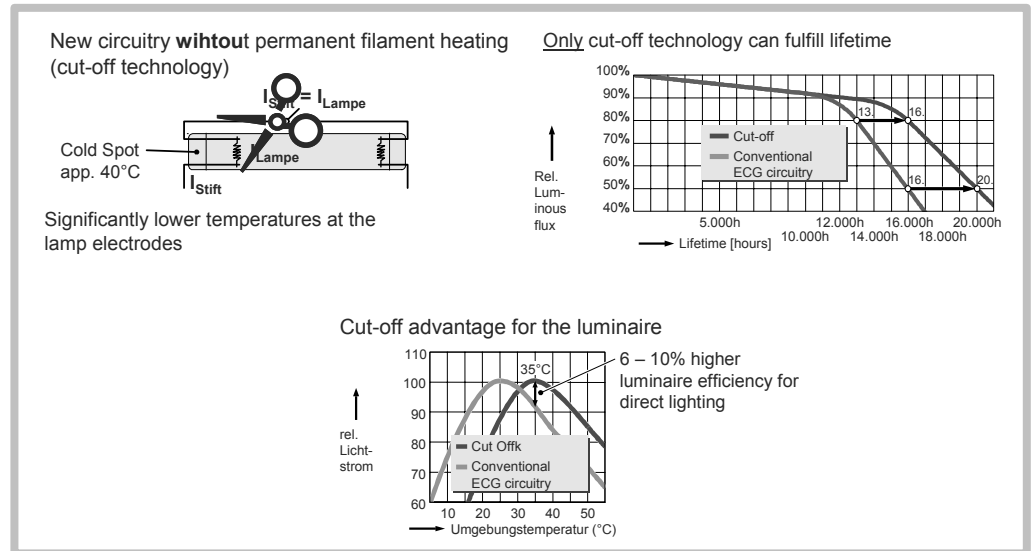

2.14.2 Physical Background

T5/Ø 16 mm-fluorescent lamps FH®...HE and FQ®...HO are designed to have their maximum lumen output at 35 °C (compared to 25 °C for T8/Ø 26 mm). For T5/Ø 16 mm-fluorescent lamps the so-called cold spot (the point where mercury condensates in a discharge tube, stamped end of the lamp) is located behind the electrode (see graphics) which means near the source of heat.

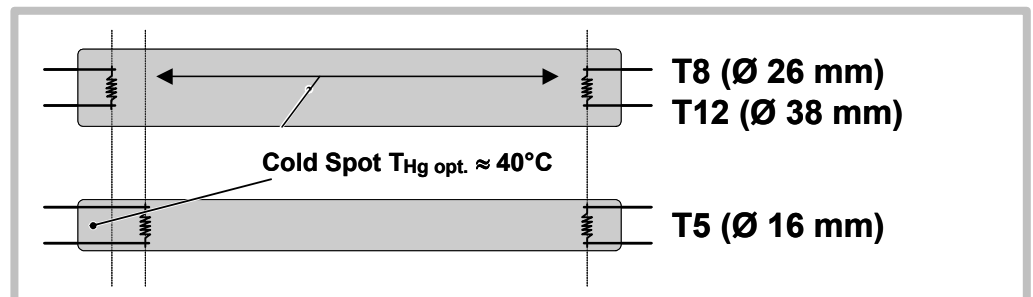

The value of the luminous flux at the ambient temperature of 35 °C is only informative for the luminaire manufacturer. Significant is the value of the cold spot temperature. This value is measured at the socket of the stamped side, approx. in a distance of 2 mm of the glass. For an optimized luminous flux this value should be between 45 °C and 50 °C. This is shown at the so called 'Horseshoe curves' where the luminous flux is shown in relation to the lamp ambient temperature.

The cold spot of the T5/Ø 16 mm fluorescent lamps is influenced by permanent filament heating. This means that higher temperatures reduce the luminous flux. ECG with cut-off technology reduce the losses of the system and are optimized regarding the maximum luminous flux of the

system. The cut-off of the permanent filament heating after lamp ignition is an advantage.

Further the values of the horseshoe curves also indicate the arrangement of the lamps within the fixture. To avoid thermal influences of the lamps minimum distances in between have to be kept. The lamps have to be placed that the stamp of all lamps is on the same side. For vertical arrangement the stamp of the lamp always should be placed down. For circular lamps FC the socket has to be placed down.

The measurement of the cold spot temperature is especially important for the luminaire manufacturer. This temperature offers opportunities to optimize the luminaire efficacy.

2.15 End of Life (EoL acc. to T.2)

Fluorescent lamps use up their emitter during operation. The complete loss of emitter on an electrode results in a voltage increase in the vicinity of the electrode filament. As most Electronic control gear have no problem providing this high asymmetric voltage and with it the required additional power the temperature around the electrodes rises significantly.

At the moment the international ECG safety standard IEC 61347-2-3 is under revision. In the future, all ECG must provide a "end-of-life" safety shutdown which is continuously controlled in order to avoid overheating of lamp sockets.

The actual status of the standard considers three different test circuits for Electronic control gear. If an ECG complies with one of the three tests, it offers protection against the "end-of-life" behavior of fluorescent lamps.

- Asymmetric pulse test (Test 1)
- Asymmetric power test (Test 2)
- Open filament test (Test 3)

The asymmetric power test (Test 2) is directly simulating the additional load which results from the increased asymmetric voltage in the case of "end-of-life". In order to pass the test the additional load may not exceed a specific value depending on the lamp type. Most ECG experts see test 2 (asymmetric power test) as the safest "end-of-life" control, because the direct measurement of the asymmetric additional load mirrors the real lamp behavior at its end of life. OSRAM does not compromise the safety of Electronic control gear and has, for quite some time, specified Test no. 2 as standard test.

2.16 U-OUT

U-OUT a binding ECG label according to safety standard EN 61347-2-3. The former standard EN 60928, still valid until 2006, allows labeling of U-OUT either in the product catalogue or on the ECG housing. U-OUT specifies the largest effective working voltage between

- Lamp terminals
- Each lamp terminal and earth connection, if applicable

This information is important for all components electrically connected on the lamp side of the ECG.

All components such as lamp cables, sockets (EN 60061-2), isolating

material and everything coming in contact with the ECG lamp terminals must be laid out according to U-OUT. OSRAM, as manufacturer, takes care that no higher voltage appears at the lamp terminals than specified by U-OUT. Therefore no additional voltage reserve is needed.

2.17 Approval Marks

2.17.1 ENEC-Approval Mark



stands for **E**uropean **N**orm **E**lectrical **C**ertification. The ENEC approval is also a conformity mark agreed upon between the testing institutes of the European union.

It stands for compliance with the according European standards for safety and performance. Besides sample testing ENEC includes also a permanent control of products and production processes. This certification is testimony of an independent and competent institute testing the safety and performance of Electronic control gear. The number right beside the approval mark identifies the certifying institute. For example 10 is representing VDE in Germany.

The ENEC approval mark for ECG to operate fluorescent lamps includes the safety standard EN 61347 and the performance standard EN 60929.

2.17.1.1 Safety acc. to EN 61347

This standard contains the safety requirements of electric units for operation of lamps that are designed for DC- and AC-voltage at 50 or 60 Hz. It is divided into different parts.

The first part EN 61347-1 deals with general and safety requirements.

- b) Electronic control gear to operate with AC-voltage at 50 or 60 Hz with an operating frequency different from the frequency of the mains supply and to operate fluorescent lamps according to IEC 60081 and IEC 60901 and other fluorescent lamps for high frequency operation are dealt with in part EN 61347-2-3.

This safety standard whose part EN 61347-2-3 together with the general part EN 61347-1 succeeds the former standard EN 60928, is also called „omnibus“ standard.

2.17.1.2 Performance acc. to EN 60929

This standard specifies the performance of Electronic control gear for fluorescent lamps. It defines the operation at AC-voltage, at 50 or 60 Hz and with a supply frequency different from the operating frequency. It is based on performance standards for fluorescent lamps EN 60081 and EN 60901.

2.17.2 VDE EMC mark



The independent testing institute confirms the compliance of the ECG with the EMC regulation regarding immunity, radio interference suppression and harmonics. At the same time, it is also a confirmation for the CE label that can be applied to ECGs by the manufacturer himself under compliance with the EMC regulation. Luminaire manufacturer can significantly reduce their costs and approval efforts with regards to EMC compliance by using already EMC approved ECGs.

2.18 Energie Efficiency Index EEI

This label helps consumers identifying the energy consumption of a product. Usually, all Electronic control gear have the best ratings A2 ...A3. Dimmable ECG are classified as A1. Magnetic ballasts (CCG) fall under the energy efficiency class C and D and are either already banned from the market or are about to be banned shortly. Low loss ballasts are usually classified in B.

2.19 CE Labelling



Since January 1996, all products falling under the EU directive of electromagnetic compatibility (EMC) must carry the CE label. The CE label indicates the compliance with the requirements of this directive. From January 1997 all products falling under the Low-Voltage directive must also be CE labeled. There is no question that our products comply with the specific EU directives and therefore are labeled with the CE mark.

Regarding CE labelling here the following explanations:

1. CE-label as basis to introduce product to the market

Since 01.01.1996 manufacturers and importers are obliged to apply CE labels to products that have to comply with EMC regulations either directly on the product, its packaging or the accompanying documents. CE labels are obligatory for the sale of products within the European Union. By applying the CE label manufacturers or importers confirm that their products comply with the "basic requirements" of specific European directives and fulfill their protective goals (for example electromagnetic compatibility). Usually the compliance of particular "basic requirements" is given products are manufactured under consideration of harmonized European standards.

2. CE label is a mark for administrative authorities

The CE label is targeted primarily at administrative authorities. It declares to them that CE labeled products comply with European jurisdiction at the time of sale.

3. No rights for commerce and endusers of examining declarations of conformity issued by manufacturers.

The right to ask for and examine declarations of conformity is reserved to authorities controlling the compliance of electric/electronic products with the legal safety requirements. In Germany it is the "Federal Agency for Post and Telecommunication" BAPT (responsible with regards to the EMC directive) and the trade supervisory boards (responsible with regards to the Low-Voltage directive).

4. CE labels are no quality or approval marks

The only purpose of the CE label is to testify that a product complies with legally specified „basic requirements“ of certain directives. It

does not make any statement with regards to the quality of labeled products. As a legal administration label without value for endusers it should not be mistaken as an approval mark issued by independent testing institutes (such as ENEC or VDE mark). These testing institutes do also not control the legitimacy of an applied CE label.

2.20 CCC Approval



Approval mark of the Chinese testing institute CQC (China Qualification Center).

Since 01.08.2003 this approval mark is required in order to sell Electronic control gear for operation of low pressure discharge lamps in the Chinese market.

OSRAM QUICKTRONIC for operation of T5/∅ 16 mm- fluorescent lamps FH[®]...HE and FQ[®]...HO carry this approval mark.

3. ECG installed in Luminaire: Installations and Operation Instructions

3.1 Wiring Instructions

3.1.1 Cable Types

Please pay attention to the voltage value U-OUT imprinted on the ECG housing when wiring luminaires for FH[®]...HE or FQ[®]...HO fluorescent lamps. This value indicates the possible cable type.

For voltages greater than 430V cables with the classification H07 have to be used.

U-OUT is the maximum voltage that can occur between the lamp terminals or the lamp terminal and the earth connector.

For all OSRAM QUICKTRONIC ECG for operation of T5/Ø 16 mm-fluorescent lamps FH[®]...HE and FQ[®]...HO U-OUT is less than 430V allowing luminaires to be wired with cables H05.

Cable types are specified through the terminals in use.

3.1.2 Cable Cross-Sections

The cable cross-sections are marked on the identification plate of the Electronic control gear.

Combi-Wiring (CW) stands for use in automatic or manual wiring. ECG in 30 mm height have the annex CW at the end of the type. ECG types without CW are suitable for manual wiring only in this height. T5-ECG in 21 mm height don't have this annex as they are equipped with CW terminals only for manual or automatic wiring.

For manual wiring of the IDC a special tool is available for example from WAGO. This tool is listed and can be ordered from WAGO under the order number 0206-0831.



Ancillary for manual wiring of the IDC-contact of the CW terminals

3.1.2.1 ECG in 30 mm height

Typical values for **Combi-Wiring** terminals of ECG with **30 mm** height are:

a) **Single-core cables**

These should have a cross section of 0.5mm² at least and 1.5 mm² at most for the **horizontal plug**.

When using **Insulation Displacement Contacts (IDC)** cables should have a maximum cross section of 0,5 mm²

b) **Multi-core cables horizontal plug**

These should have a cross section of 0,5 mm² at least and 1 mm² at most.

Multi-core cables can be inserted directly into the horizontal plug terminals.

Ferrules may be used but they are not essential.

IDC

Multi-core cables with a cross section of 0,75 mm² can be used for direct wiring with IDC.

3.1.2.2 ECG in 21 mm height

Typical values for **Combi-Wiring** terminals of ECG with **21 mm** height are:

c) **Single-core cables**

These should have a cross section of 0,5 mm² at least and 1 mm² at most for the **horizontal plug**.

When using **Insulation Displacement Contacts (IDC)** cables should have a maximum cross section of 0,5 mm²

d) **Multi-core cables horizontal plug**

These should have a cross section of 0,5 mm² at least and 1 mm² at most.

Multi-core cables can be inserted directly into the horizontal plug terminals.

Ferrules may be used but they are not essential.

IDC

Multi-core cables with a cross section of 0,75 mm² can be used for direct wiring with IDC.

3.1.3 Release of Contacts

3.1.3.1 WAGO 250

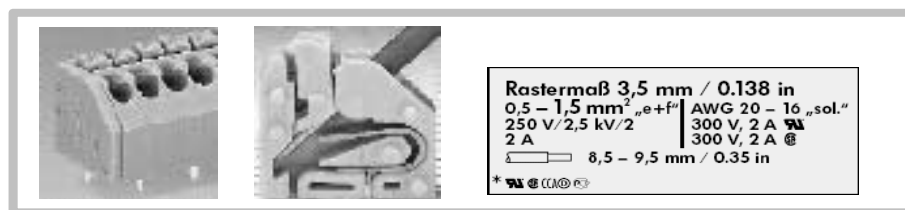

Release the contact by using the release latch.

3.1.3.2 WAGO 251 – IDC

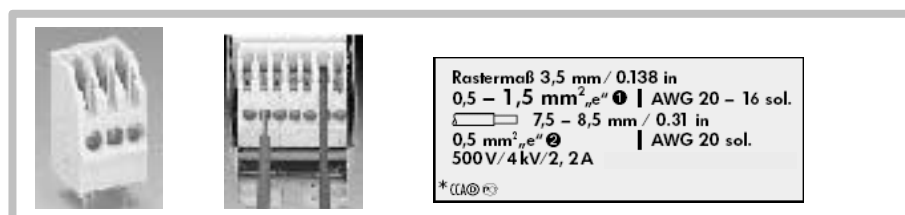

Release the contact by pulling the cable upwards.

This process can be repeated up to 10 times (depending on the manufacturer) without damaging the terminal. For further details please refer to the data sheets of the manufacturers.

3.1.3.3 WAGO 251 – horizontal plug

WAGO 251 – horizontal plug

The contact can be released with the help of a small screw driver as

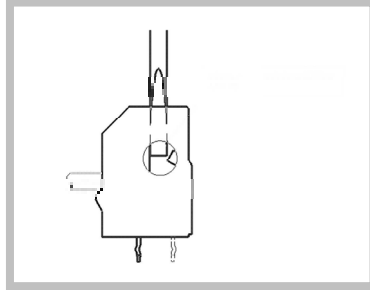

Alternatively the contact can be released by simultaneously twisting and pulling the cable.

3.1.3.4 WAGO 251 mini – IDC

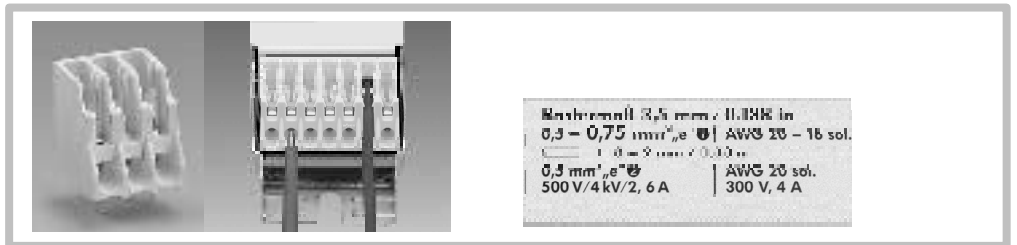

Release the contact by pulling the cable upwards.

This process can be repeated up to 10 times (depending on the manufacturer) without damaging the terminal. For further details please refer to the data sheets of the manufacturers..

3.1.3.5 WAGO 251 mini – horizontal plug

The contact can be released with the help of a special manual tool as shown in the picture below. The tool can be ordered from WAGO under the order number 0206-0830.

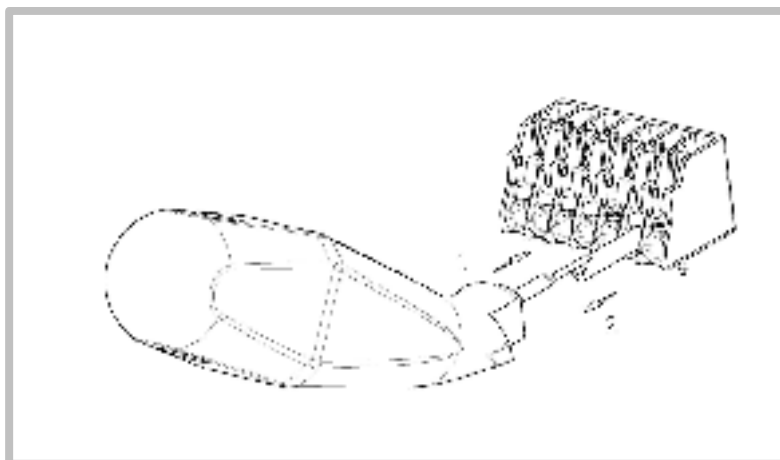

Alternatively the contact can be released by simultaneously twisting and pulling the cable.

3.1.4 Insulation

Depending on the type of terminal the length of insulation to be stripped from the ends of the cables is different. The exact value can be found on the ECG.

	WAGO 250	WAGO 251	WAGO 251-mini
Stripped Insulation [mm]	8-10	8.5 - 11	8.5 - 11



3.1.5 Terminals

	h = 30 mm	h = 21 mm
QT-FQ...CW	WAGO 251	
QT-FH MULTI...CW	WAGO 251	
QT-FH...F/CW		WAGO 251 mini
QT-FQ...F/CW		WAGO 251 mini
QT-FQ 2x80		WAGO 251 mini
QTi		WAGO 251 mini

3.1.6 Cable routing

To ensure good radio interference suppression as well as maximum safety and reliability, the following rules for cable routing should be observed:

- 1.) Cables between ECG and lamp (HF cables) should be kept as short as possible to reduce electromagnetic interference. Please pay attention to the maximum recommended cable lengths as indicated on the ECG (see also overview in 7.1ff)
- 2.) Mains and lamp cables should never be routed in parallel. Keep HF cables and mains cables as far away from one another as possible (e.g. 5 to 10 cm). This avoids mutual interference between mains and lamp cables.
- 3.) Lay HF cables away from earthed metal surfaces (if possible several cm away) to reduce capacitive interference.
- 4.) If long HF cables are unavoidable (e.g. in master-slave circuits) they should be twisted together.
- 5.) Keep mains cabled in the luminaire as short as possible to reduce interference.
- 6.) Do not lay mains cables too close to the ECG or the lamps. This applies in particular to through-wiring.
- 7.) Avoid crossing mains cables and lamp cables; if this is not possible, they should cross at right angles to reduce mains and HF interference.
- 8.) Lamp cables at high potential (see section 7.1ff „Hot wires“) must be kept as short as possible, particularly with luminaires for tubular fluorescent lamps such as FH® ...HE and FQ® ...HO.

Wiring must comply with the latest versions of the relevant national standards. Cable entry through metal components should never be left unprotected but should be fitted with additional insulation (sleeve, grommet edge protector etc.)

The body of the luminaire or parts thereof must never be employed as a conductor or in any way come into contact with mains or lamp cable conductors (for example as a result of bare cables, too much insulation stripped away, screws protruding through insulation, or sharp metal edges). There is a serious risk that a person may be electrocuted and the control gear damaged beyond repair.

If you are wiring a number of luminaires from a 3 mains supply in a loop (with 5-core cable, for example), you must also ensure that are never connected two phases to the ECG mains terminal instead of the group phase, the neutral conductor and the PE conductor. Otherwise the ECG may fail immediately or within a short time. (see also section 8.4, Troubleshooting)

L and N interchangeable (e.g. for mobile luminaires)?

- Yes case labeling ≈ or
- No case labeling L N

3.2 Electromagnetic Compatibility

The abbreviation EMC stands for **ElectroMagnetic Compatibility**. EMC specifications define a series of different test criteria. The most important in connection with electronic control gear are radio interference suppression, harmonic content (up to the 39th harmonic) and immunity to interference.

	IEC International	European standard
Radio interference suppression	CISPR 15	EN 55015
Harmonic content	IEC 61000-3-2	EN 61000-3-2
Immunity to interference	IEC 61547	EN 61547

The CE symbol on OSRAM QUICKTRONIC control gear indicates compliance with immunity to interference, harmonic content and radio interference suppression requirements. By using the CE label OSRAM, as manufacturer of ECG, confirms the compliance with the requirements of the standards (see also Section 2.17.2 CE labeling).

3.2.1 Harmonic Content acc. to EN 61000-3-2

Lighting equipment is subject to restrictions on harmonics. The maximum permissible threshold values are defined for two classes of equipment:

- Class C: Effective input power (system wattage) > 25W
- Class D: Effective input power (system wattage) < 25W

The requirements for Class D equipment must be met as of January 1, 2001.

Harmonic number	Proportion in % of the mains current of the fundamental wave (50 Hz)
2	2
3	30 x power factor(λ)
5	10
7	7
9	5
11 < n < 39	3

The specified values apply to Class C ECGs.
OSRAM QUICKTRONIC® control gear typically exhibit values well below the threshold values.

All QUICKTRONIC® units for operation of T5 FH®...HE- and T5 FQ®...HO fluorescent lamps have a total harmonic distortion (THD) of less than 10%.

3.2.2 Radio interference suppression

Compliance with the limit values for radio interference suppression is also a requirement for the VDE EMC approval.

The ECGs are measured in a reference luminaire.

However, the interference level depends not only on the ECG but also on the arrangement of the lamp and ECG, the luminaire design and in particular the wiring. To obtain approval, compliance with the limit values has to be checked for each luminaire (by the VDE for example).

This is discussed in more detail below.

3.2.2.1 Causes of Radio Interference

Radio interference refers to both the radiated and the mains-borne influences of an electrical load on other units connected to the same mains supply and/or in the immediate vicinity. See also Section 4.8.

To ensure that the various electrical loads can operate simultaneously and trouble free, each unit must not exceed certain radio interference values.

A distinction is made here between mains-borne disturbances on the power supply side and atmospheric disturbances due to electromagnetic fields in the vicinity of the luminaires.

3.2.2.2 Conducted Interferences acc. to EN 55015

These disturbances are caused by non-linear components and the high frequency operation.

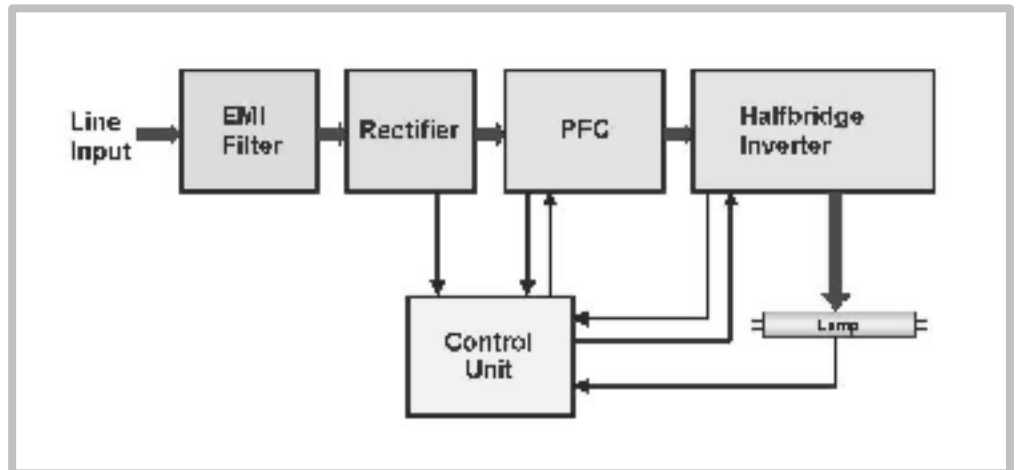

By using complex input filters it is possible to reduce these disturbances to a level well below the limits prescribed by the relevant standards. Each and every OSRAM ECG complies with these standards. The way in which an ECG is installed in a luminaire, however, can have a considerable influence.

(see Section 7.5 Installation instruction for luminaires)

3.2.2.3 Disturbances due to Fields

Owing to the various dynamic electrical and physical processes in the ECG-lamp system, there is always an electromagnetic field around the luminaire. In defining its effects, a distinction is made between electric and magnetic components.

a) Electrical fields

Because of the high-frequency output voltage the lamp and lamp wiring generate an electrical field. This is attenuated to a level well below that prescribed in the relevant standards by filtering on the output side and by suitable circuit design. What applies to an individual ECG does not always automatically apply to the entire system once the ECG has been installed in the luminaire.

b) Magnetic fields

The magnitude of this field is determined solely by the lamp and the geometrical arrangement of the entire system, particularly by the areas enclosed by the lamp, ECG and wiring. The only recommendation that can be made here is to aim for a self-enclosed structure as far as possible and to comply with the wiring instruction.

3.2.2.4 Selective Shielding

The following diagrams show the magnetic lines of force for two simple linear luminaires

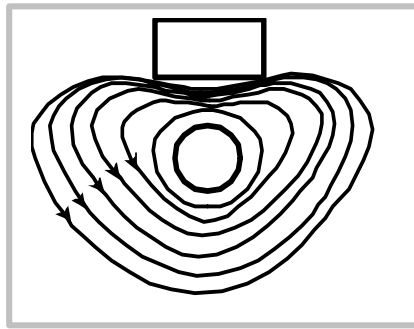

a) without reflector

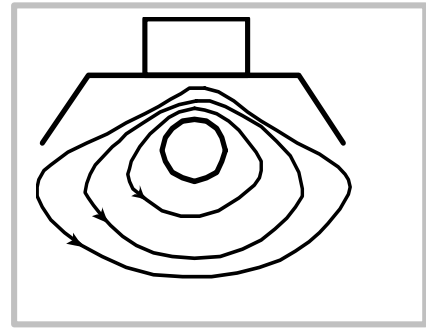

b) with a metal reflector

The resulting magnetic field strength in the near field and hence the effect on the environment is reduced in b) by a current induced in a reflector. It is important here for the surface of the reflector to have good electrical conductivity. It is not necessary to earth it.

To shield the electric field, which is always radial around the lamp, it is necessary for the reflector or its surface to be as conductive as possible and for the connection to earth or to protective earth to be of the lowest possible resistance.

Based on these two requirements, the solution here is to have a reflector, reflector and diffuser or louver with excellent conductivity connected at lowest possible resistance to the ECG earth (PC I) or the PE conductor connection of the luminaire.

3.2.2.5 Installation Instructions for avoiding Disturbance

The following diagrams show examples of correct and incorrect wiring.

1a) Long-run luminaire with reflector

To avoid interference on the lamp cable, the mains cable should be routed to the outside immediately at the luminaire terminal. The lamp cables should be laid in accordance with the criteria specified in Section xx (wiring instructions). The reflector is used here for shielding and should therefore be made of metal and be attached permanently with a high quality plug connector (must have low resistance) to the luminaire body which in turn is connected to control gear earth.

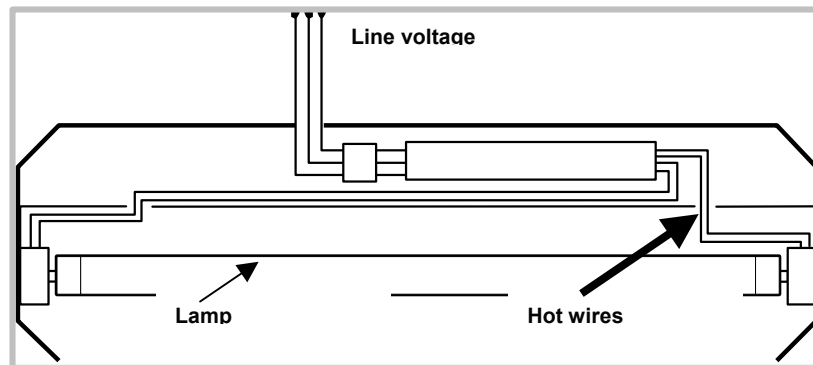

1b) Bad example

Mains and lamp cables that run in parallel over long distances. This leads inevitably to interaction and therefore to higher energy in the radiated

electromagnetic field. Serious problems can occur if, as described in Section xx, wiring instructions, the lamp cables that have high potential with respect to earth (hot wires) are not kept as short as possible by connecting them to the nearest lampholder.

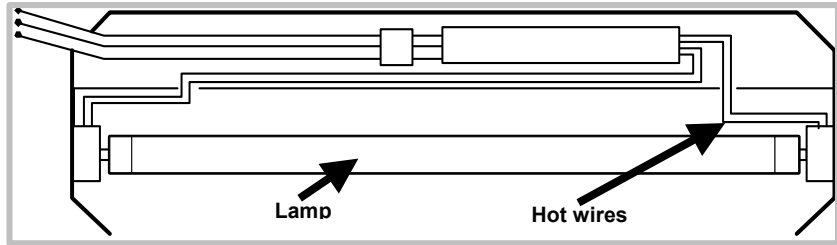

The following diagrams apply to both recessed and surface-mounted luminaires:

3.2.2.6 Asymmetric installation of ECG

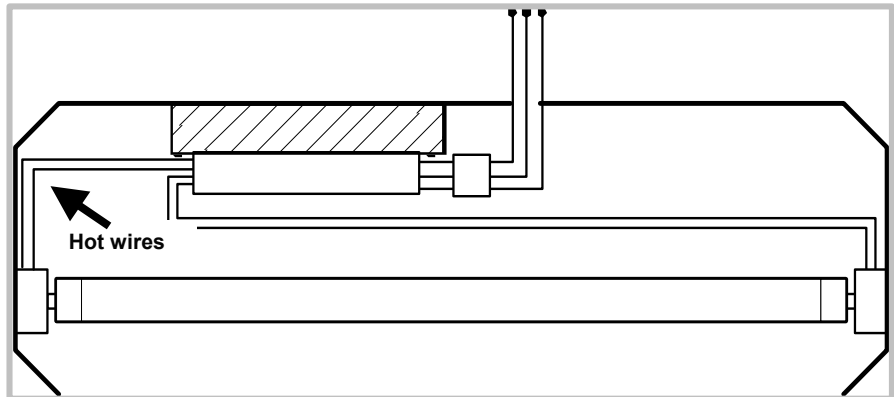

Cables should be laid close to the body of the luminaire. ECG and reflector need a low resistance earth. Wiring must comply with the recommendations in Section xx (Installation instructions for luminaires). The luminaire design provides effective shielding of the electromagnetic field.

Alternative asymmetric installation

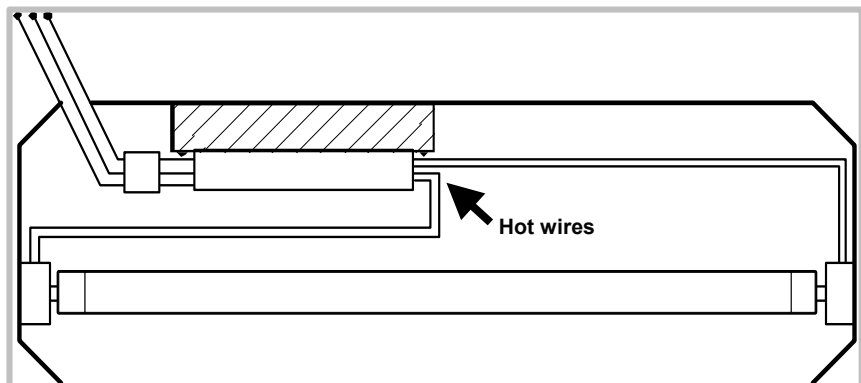

This option is equally suitable.

Bad example

The electrical connection between the ECG and the luminaire is poor. Unnecessary crossovers have been created leading to poorer and therefore higher resistance connection with earth. This arrangement is also poor from a thermal point of view.

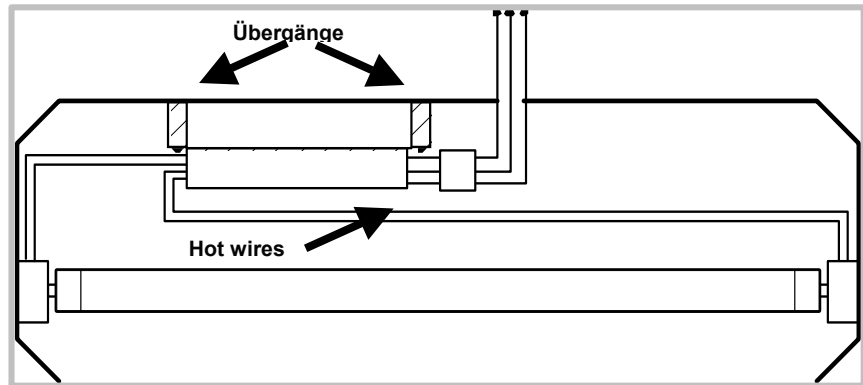

3.2.2.7 Good wiring arrangement for 2-lamp luminaires

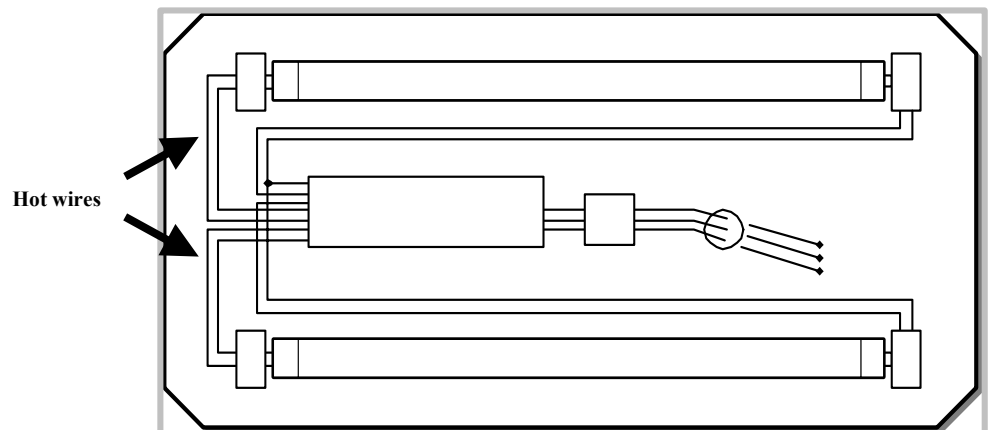

3.2.2.8 Luminaires with reflector and/or specular louvres

These parts must be made of metal or at least have a surface (i.e. anodized) with excellent electrical conductivity.

a) The reflector acts as an effective shield

Provided the reflector has a very good connection to the central earthing point, the lamp is effectively shielded and there can be no interaction with the ECG and the wiring. Electromagnetic fields are also effectively shielded.

The reflector should be connected by a short cable or screw connection to the body. A poor contact or a loss of contact at this point would have an adverse effect on the EMC behaviour of the complete luminaire and could also impair starting.

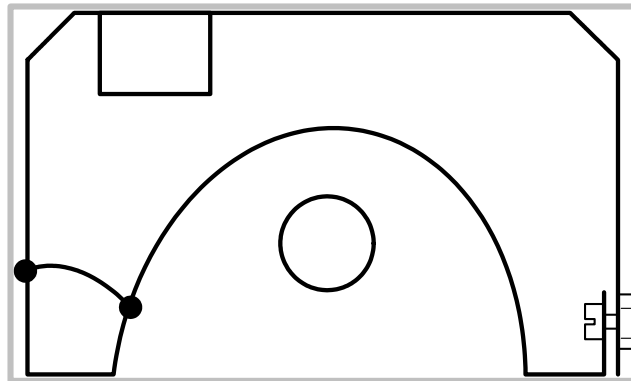

b) Louvre instead of a reflector

The same applies to louvers as to reflectors. Louvres also have to be good electrical conductors and be connected to luminaire earth.

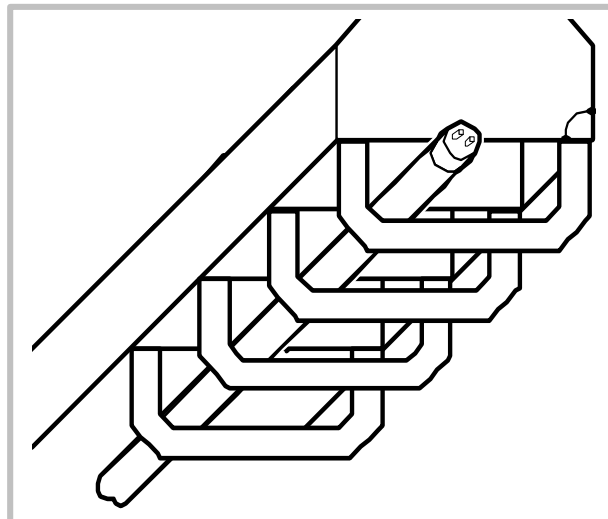

3.3 Permissible Cable Lengths

Section 7.1 refers to the maximum recommended cable lengths between the ECG and the lamp. The additional information is discussed elsewhere in this section. These maximum recommended cable lengths must be adhered to in order not to overload the ECG and to ensure that the system will start reliably even under adverse conditions (low ambient temperatures, high humidity levels, aged lamps).

In order to comply with the radio interference suppression limits, the instruction in Section xx must be followed. If the maximum recommended cable lengths for operating an ECG-lamp system are fully exploited, additional radio interference suppression measures may be needed such as shielding or separate filters. Because there are so many different interference factors involved (see Section 3.2), it is not possible to specify a maximum cable length for an ECG-lamp system below which radio interference suppression limits are guaranteed not to be exceeded.

3.4 „Hot Wires“

„hot wires“ (high potential). By this we mean the lamp cables which are at the highest potential with respect to circuit earth or protective earth. The other lamp cables are „cold wires“ and have a correspondingly lower potential with respect to earth.

„Hot wires“ are marked on the unit with the shorter cable length. For reasons of radio interference suppression and reliable starting, the “hot wires” must be kept as short as possible. In other words, you should install the ECG to one side in the luminaire, making the low-potential cables longer so that the length of the high-potential cables can be reduced. This type of installation is to be preferred to symmetrical mounting.



In luminaires equipped with more than one ECG (systems with 3, 4 or more lamps), the ECG and its associated lamp(s) should be assigned to one another. For reasons of radio interference suppression and reliable starting we do not recommend splitting the luminaire into a lamp and ECG part. QUICKTRONIC® ECG for 3- and 4-lamp operation of FH®...HE fluorescent lamps have been optimally designed to comply with just that recommendation.

For reasons given above we also advise against splitting the ECG into units located in the luminaire and units located outside the luminaire (e.g. on the back of the luminaire) if this means much longer cables between the ECG and the lamps.

3.5 Switching between Lamp and ECG

In some special applications it may be necessary to disconnect or switch the cables between the ECG and the lamp(s).

If changeover units are used (emergency lighting modules with internal switching) which supply the lamp directly from an emergency supply and interrupt the system circuit between the ECG and the lamp, the following must be observed:

- Changeover or disconnection of the lamps from the ECG to the external unit must be on all terminals.
- When switching back from the external supply to ECG operation, the lamp(s) must first be connected at all terminals to the ECG before the ECG is supplied with power again, otherwise the cutout in the ECG will operate.
- Many of these emergency lighting units available on the market do not comply with the normal operating conditions of the lamp and will therefore damage it. In such cases, OSRAM cannot guarantee that the lamp will last as long as indicated.

Wiring recommendations for OSRAM QUICKTRONIC® ECG for multi-lamp operation of T5/Ø 16 mm- fluorescent lamps with exemplary emergency units are given in Section **6.5.2ff**.

3.6 Master-Slave Circuit

An additional single-lamp „slave luminaire“ can be supplied from a two-lamp ECG installed in a single-lamp „master luminaire“.

This requires a 4-core connecting cable between the two luminaries and, in general, different cable lengths between the ECG and the lamp in the

“master luminaire” and between the ECG and the lamp in the “slave luminaire”. The following requirements apply to the physical arrangement of the two luminaires:

3.6.1 Max. length of the connecting cable between 2 luminaires

	Max. length of the connecting cable between two luminaires [m]
QTi 2x	No master-slave circuit possible
QT-FH 2x14-35/230-240 CW	1 m
QT-FQ 2x...CW	0.5 m
QT-FH 2x.../230-240 F/CW and QT-FQ 2x.../230-240 F/CW	No mater slave circuit possible

The recommended cable lengths are maximum values which must be observed. For information about cable routing in the “slave luminaire” as well as in the “master luminaire” for maximum cable lengths please see the recommendation in Section 7.1.

For maximum cable lengths please see the recommendation in Section 8.1.1ff.

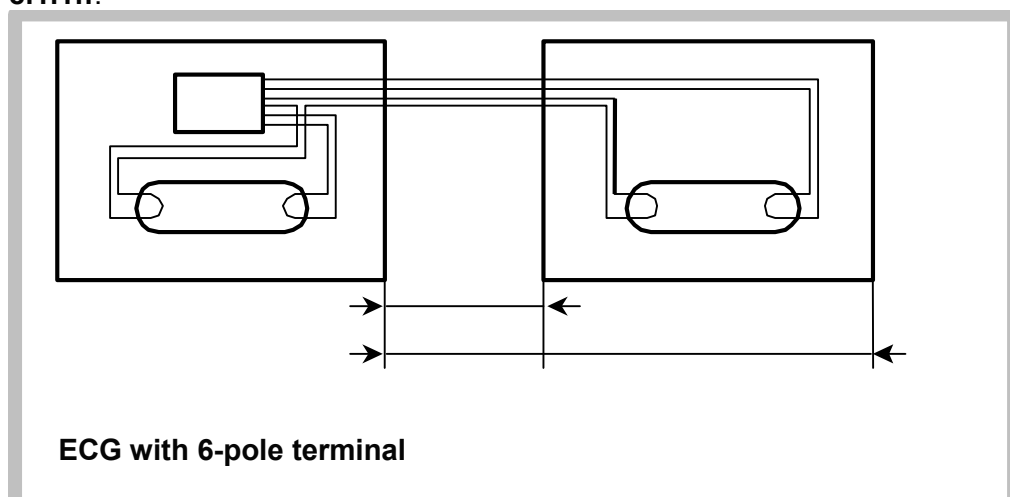

3.7 PE-Connection for Protection Class I Luminaires

Exposed metal parts of luminaires of protection class I must be reliably and permanently connected to a PE conductor. For all QT-FH... CW, QT-FQ...CW and QT...F/CW one ore both fastening screws are used for grounding. Serrated washers to improve the earth connection are recommended.

QUICKTRONIC® INTELLIGENT QTi ECGs have an additional ground terminal to suppress radio interference (“functional” earth).

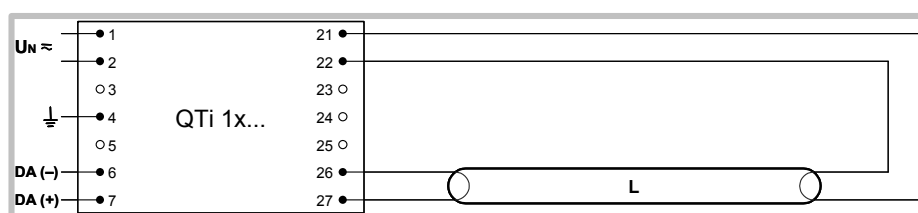

Wiring 1-lamp QTi

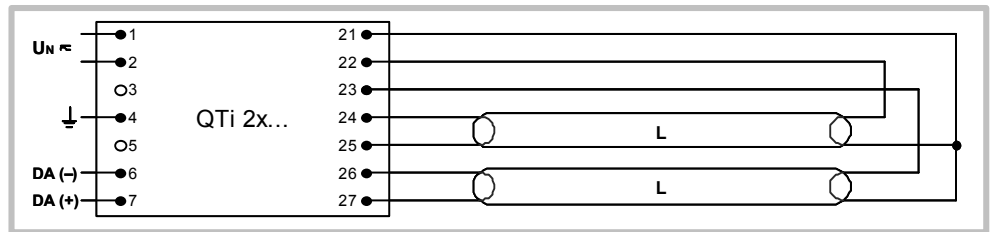

Wiring 2-lamp QTl

To obtain good radio interference suppression, the PE conductor and the line mains cables should not be laid parallel to the lamp cables or alongside the ECG.

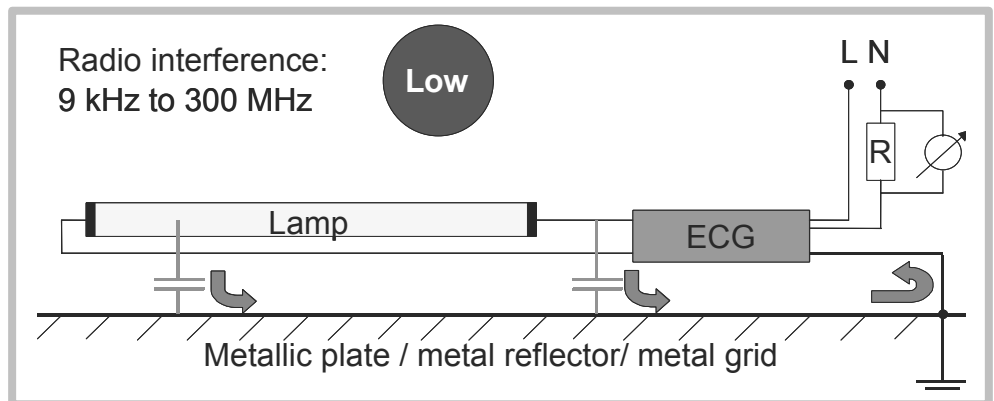

Due to the earth connection of the ECG to a metal plate or the luminaire body, an “internal” short circuit exists in luminaires of protection class I. It means that the interference and leakage currents are redirected into the ECG and, therefore, no so-called interference voltage are generated when measuring conducted disturbances according to CISPR 15. The emitted interference level of such a system is “low”.

3.8 Functional Earth for Luminaires of Protection Class II

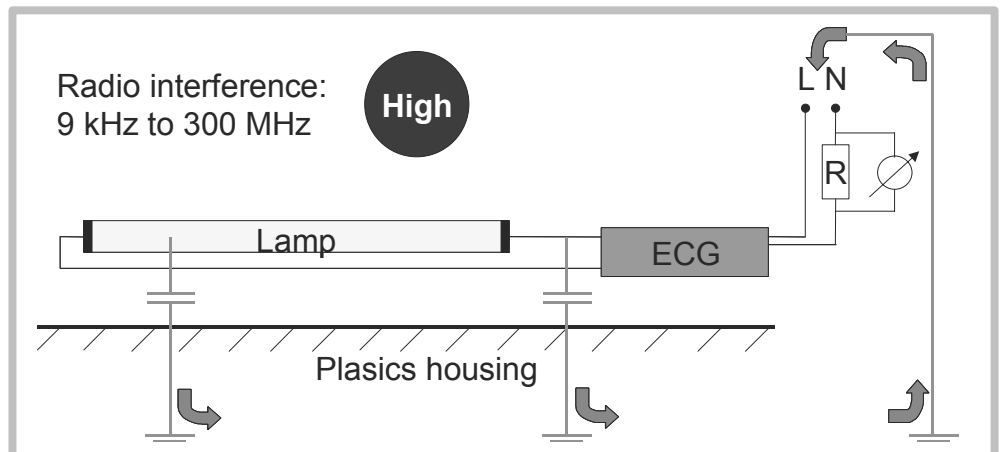

In this case, the ECG is mounted in a plastic housing. Therefore, the capacitive leakage currents generated by the system lamp and ECG are not circulating within the luminaire, they are fed back into the mains supply via the luminaire environment. The magnitude of these leakage currents depends very much on the mechanical design of a luminaire and its surroundings and on the specific features of the various lamp types (FH®...HE or FQ®...HO) and hence can be very different. They cause interferences on the mains side with regards to measurements of conducted disturbances according to CISPR 15.

3.8.1 General Information

The functional earth in this arrangement restores the internal short circuit of the system. → no interaction of the capacitive currents of the system lamp-ECG with the mains side and therefore no disturbances with regards to CISPR 15 measurements.

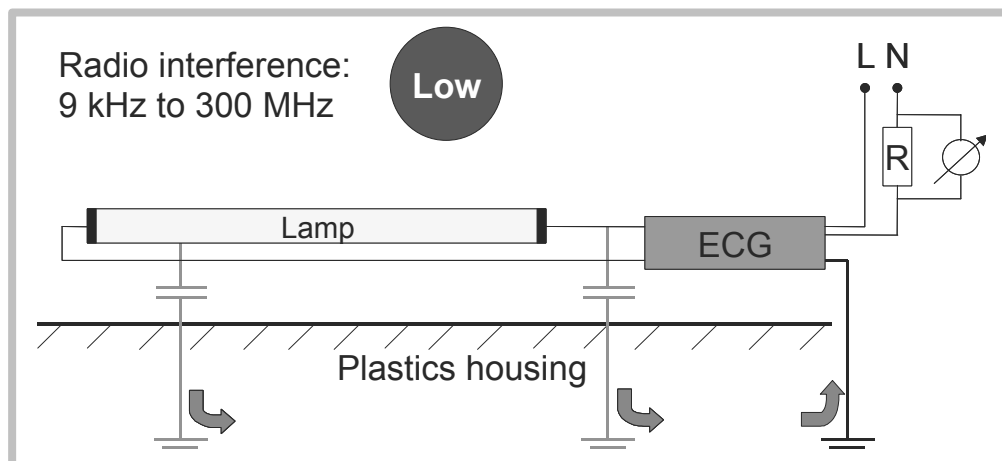

Due to the partly high lamp voltages of T5 fluorescent lamps we recommend to apply a functional earth to T5-lamps for improved radio interference suppression.

3.8.2 Practical Details

Different Electronic Control Gear have to be connected to functional earth for protection class II luminaires (potential equalisation): e.g. QUICKTRONIC® INTELLIGENT QT*i*)

There is no coherence between the functional earth and the ground wire. Thus the functional earth can be connected in luminaires of protection class II.

Attention should be paid to:

1.) Luminaire

1.1) Construction

ECG housing and wire of functional earth have to be observed as active parts.

- Requirement regarding double or boosted Insulation against metal parts or the luminaire surface have to be kept.
- the wire for the functional earth connection must not be marked in yellow/green



1.2) Terminal Labelling

Acc. to EN 60445/VDE0197 the functional earth connection has to be marked with the letters „FE“ or the below label. See label in Section 3.7.

In any case the symbol of the protective earth **must not** be used for a

functional earthing!



2.) Instruction manual

The necessity of the functional earthing of an ECG due to EMI reasons is noted in the technical data or in addition on the type label of the ECG with the appropriate symbol. The regulations for the skinning and the max. length of the wire are valid for L- and N-conductor. The length of the functional earth must not exceed the max. length of the other wires. IEC 60363/VDE V0800-2-548 have to be observed for the functional earthing.

3.) Manufacturing

As the functional earthing isn't a safety measure of the luminaire, the test of the ground wire connections can be omitted.

3.9 Temperature Ranges

To guarantee a reliable operation temperature ranges indicated on the housing (ambient temperature of the ECG) as measurement temperature to have to be observed. In general, the lower the operating temperature of an ECG the higher its service life.

(See Section 2.10, Reliability of ECG)

The temperature must be assessed separately for the two system components (ECG and lamp). In the case of the lamp, there are physical laws that restrict the temperature range, whereas in the case of the ECG fixed limits must be set in order to ensure reliable operation. Apart from this, there are external factors such as the reciprocal influences of ECG, lamp and luminaire and the selected installation site which all of which have an influence. Compliance with the specified limits and hence the guarantee of the operational reliability are the responsibility of the relevant luminaire or system manufacturer.

Operation of electronic control gear outside the recommended temperature ranges can result in the following behaviour:

ECG ambient temperatures are too low:

Fluorescent lamps cannot be started reliably. At too low temperatures some electronic components may not be functional or at least limited in their operation.

ECG ambient temperatures are too high:

ECG life shortened or ECG even damaged. → High ECG failure rate.

Important:

These limit temperatures apply even if the units are not in operation or are in storage.

Typical temperature values for storage of ECG are:

Storage temperature: -40 °C to max. +80 °C

Humidity: 5 % to max. 85 %

3.9.1 Self heating ECG

Because of their low losses, OSRAM QUICKTRONIC® ECG for operation

of T5/Ø 16 mm- fluorescent lamps FH®...HE and FQ®...FO have a very low thermal output, producing typically between 10 °C and 20 °C temperature rise. It allows a wide range of ambient temperatures which is covering almost all applications. If not, adequate measures must be taken in the luminaire or at the site of installation to improve the thermal balance of the luminaire.

If the limit temperature is expected to be exceeded for only short periods (less than one hour, as may be the case in outdoor installations in direct sunlight), but most of the entire time the operating temperature is below the maximum recommended value (at night-time, for example), a certain balance between reduction and extension of service life may be expected. However, there is no guarantee from our side that this will be the case.

The temperature at the tc point must never be exceeded by more than 10 °C, otherwise the unit is very likely to suffer permanent damage.

ECGs may also suffer permanent damage if they are operated below the specified minimum temperature. As already mentioned, if the lamps are also too cold, there will be problems with starting, low luminous flux and a shift towards the red end of the spectrum.

3.9.2 Control Gaer Temperatures

For installing ECGs in luminaires, the measuring point temperature tc on the case is of major importance in any thermal analysis. The maximum recommended value for the unit and marked on the housing must not be exceeded in order to reach the service life as specified in the data sheet.

To obtain a safety approval according to EN 60598 for a luminaire, this temperature limit may be exceeded by up to 5 °C. However, this application has a reducing effect on the ECG service life.

3.9.2.1 Measuring Point Temperature tc

According to EN 60598, tc (c stands for case) is the maximum recommended temperature that may occur at an indicated point on the ECG (Tc measuring point) during normal operation at rated voltage and within the specified temperature range.

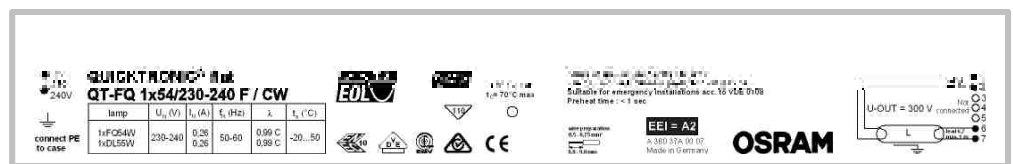

In practice, the temperature rise of the housing results from the self-heating of the unit, which in turn results from the power loss and the ambient temperature of the ECG. This is influenced by the position of the lamp and the design of the luminaire and is consequently always higher than the ambient temperature of the luminaire.

Exceeding the maximum recommended tc temperature by a few degrees drastically reduces the expected service life of the unit. If the temperature is exceeded by more than 10 °C, a 50 % reduction in service life can be expected. At 20 °C or more above the maximum recommended temperature the unit is likely to fail very quickly. The limit temperatures of various electronic components, such as transistors, are primarily responsible for this.

If, however, the temperature at the tc point is permanently 10 °C or more below the maximum, the expected service life of the unit will be approximately doubled.

3.9.2.2 Ambient Temperature ECG : ta

According to EN 60598-1, ta (a stands for ambient) is the maximum value of the steady state temperature at which, during normal operation, limit temperature tc is not exceeded at the measuring point.

Also according to EN 60598-1, there are precisely defined testing and measuring requirements for both surface mounted luminaires (pendant and portable, for example floor lights) and recessed luminaires.

3.9.3 Lamp Temperature

The maximum values specified in the lamp documentation for cold-spot temperature (see Technical Specification T5 Fluorescent Lamps) are important operating criteria for the lamp and must not be exceeded nor fall below under any circumstances in order to achieve optimum luminous flux. The ambient temperature to reach the maximum lumen output is 35°C for T5/Ø 16 mm fluorescent lamps FH®..HE and FQ®...HO, and 25 °C for FC® - circular fluorescent lamps

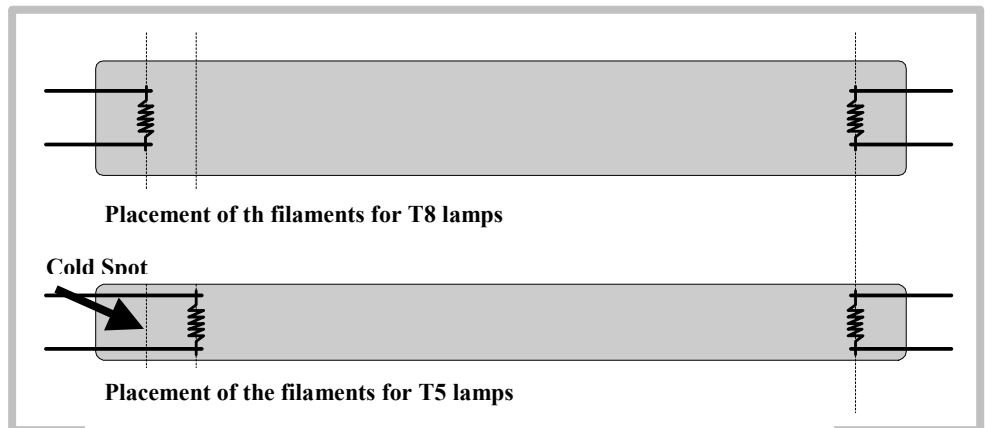

Further lamp and ECG should not heat each other. ECG should be dissipated through good thermal connection between ECG and luminaire housing.

3.9.3.1 Maximum Luminous Flux for T5/Ø 16 mm-Fluorescent Lamps

Usually, T5-fluorescent lamps reach their standard electric properties (rated values) which are used for lighting design purposes at ambient temperatures of 25 °C. Their maximum light outputs, however, are achieved at ambient temperatures of 35 °C.

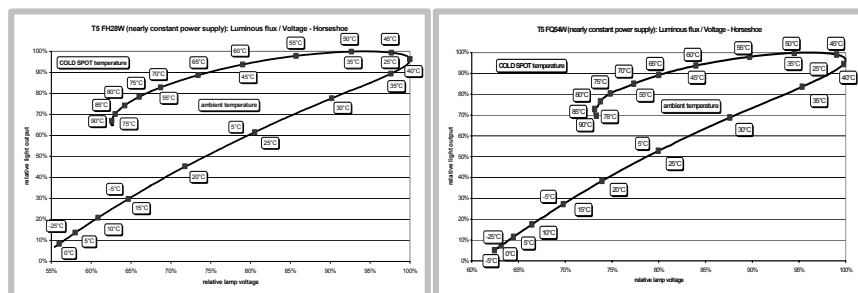

Luminous flux FH®...HE and FQ®...HO fluorescent lamps related to the lamp ambient temperature

At significantly lower or higher cold-spot temperatures than the specified temperature the electrical properties of the lamps change drastically and there is a significant reduction in luminous flux.

In normal cases of significant deviations, the shutdown mechanism in the ECG will operate. In extreme cases there may be damage to the electronic control gear.

If the lamp temperature is too low it may be difficult to start and the luminous flux may be too low. Selecting a different site for installation generally helps, or using some kind of outer tube to conserve the heat of the lamp. It is important that this outer tube is installed on the etched lamp side around the electrode (cold spot). In any case, we recommend that luminaire manufacturer informs the electrician by printing the information on the inside of the luminaire.

If the ambient temperatures are too high the ECG can be damaged and the light output is too low. An optimized cooling is necessary. In order to avoid a thermal interference when operating a multi-lamp T5-system, it is required to install the lamps always with the lamp etch on one side.

3.9.4 General Recommendations for Installation

It is important to ensure that the lamp and the ECG are positioned in the luminaire so that they do not mutually heat one another and that the ECG power loss can be properly dissipated even at the maximum expected ambient temperature and/or supply voltage.

The tc-temperature at the measuring point on the ECG must not be exceeded during operation even at the maximum expected ambient temperature and/or supply voltage. Under "normal" ambient conditions the tc-temperature measured at the measuring point should be at least 5 °C to 10 °C below the specified maximum value so there is a safety margin to allow for extreme situations.

It may be necessary to split lamp and ECG (with, say, the lamp in the luminaire and the ECG in the stand or luminaire support) such that the absence of special measures the lamp and the ECG would not mutually heat each other if arranged in close proximity, leading to excessive temperatures of the lamps and/or the ECG. In such arrangements ensure that the maximum cable length between ECG and lamp(s) is not exceeded and the wiring instructions under Section 4.1 and 7.1 are followed.

3.9.5 Measuring the Temperature

The simplest way to measure the relevant temperatures on the lamp (especially at the cold-spot) and on the ECG (tc point) is with thermocouples fixed to the lamp/ECG and a suitable measuring instrument. Make sure the adhesive used is neutral in terms of its thermal, electrical and photometric properties.

To measure the ECG temperature it is convenient to have a thermocouple permanently attached to a housing cover and to exchange this for the original cover.

The temperature values should only be measured when the steady-state temperature has been reached (in other words, when there has been no

significant change in temperature for some time). The supply voltage should be held constant at least throughout the entire measuring cycle at the rated voltage of the lamp.

The **following procedure** is recommended for the thermal analysis of the luminaire, taking into account the design requirements specified in EN 60598-1:

1. Thermal situation in the luminaire without control gear heat. Luminaire in measurement setup according to EN 60598-1 in standard mounting position, equipped with ECG and lamp and fitted with thermocouples. The lamp is supplied from external control gear, and not from the built-in ballast. In this way the temperature rise in the entire set-up resulting only from the lamp can be measured and the thermal “link” to the environment can be optimized.
2. Thermal situation in the luminaire with control gear heat. Arrangement as described in 1., but the lamp is supplied from internal control gear. By comparison with the measured values obtained already, the additional heat generated by the ECG can now be assessed.

3.10 Luminaire Wiring Test for Two-lamp Luminaires

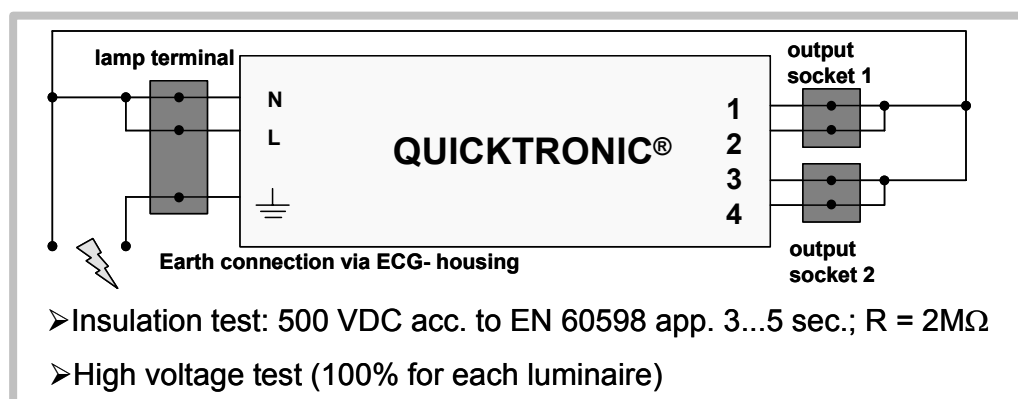

3.10.1 Testing with a Test Adapter and Dummy Lamps

A more precise wiring test for two-lamp luminaires than the one described in Section 3.10.1 can be performed with a test adapter (own design with the resistors shown in the diagram) and a sample tube (dummy lamp with sockets measuring the resistance). This test can be used for two-lamp luminaires equipped with the before mentioned ECGs.

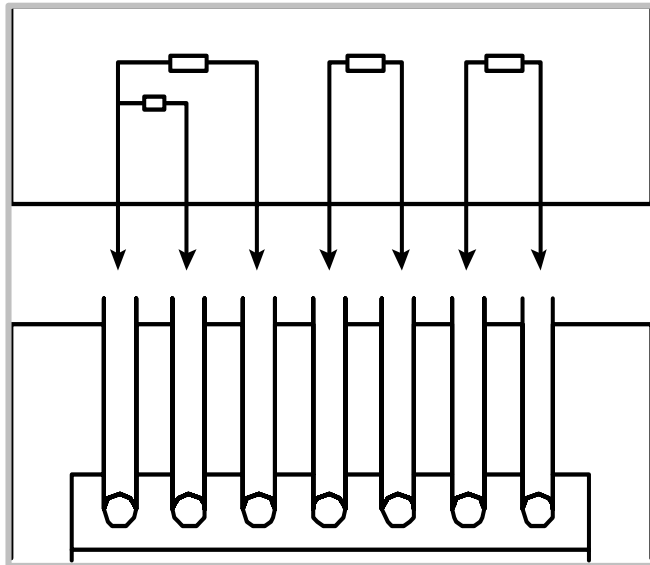

The test is performed on the wired luminaire without mains voltage and without lamps.

1. The test adapter is inserted behind the release lever of the 45°-plug-in terminals or, in the case of combi-wiring terminals, in the respective non-wired IDC or horizontal plug-in contact.

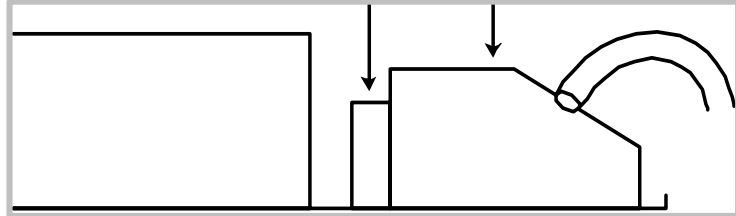

2. Instead of the lamps the two dummy lamps are inserted in the lampholders of the empty luminaire.

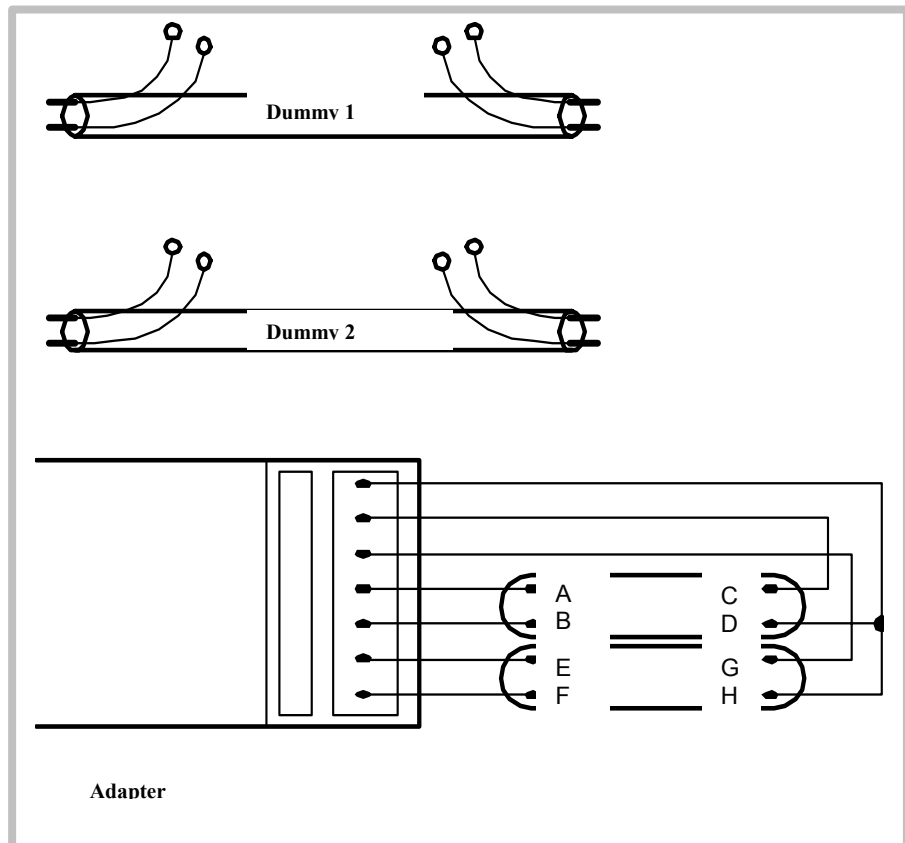

3. Measure the resistance between A and B and between C and D. The resistance between A and B and between C and D should be 100 Ω.
4. Measure the resistance between E and F and between G and H in the same way.

If the measured resistance is not 100 Ω, the wiring is incorrect.

3.11 ECG Operation for Luminaires of Protection Classes I and II

In accordance with EN 60598, luminaires are grouped into protection classes according to the measures taken against contact with high voltages.

In the case of protection class I luminaires, all accessible parts which may become live as a result of a fault must have a good conductive connection to the PE conductor. The conductive link between the luminaire and the ECG must not be provided by the PE conductor of the ECG but by appropriate mechanical design features (such as using serrated edge washers or serrated head bolts).

In the case of protection class II luminaires, live parts must be provided with reinforced or double insulation. Protection class II luminaires do not therefore have an earth connection (except protection class II luminaires with functional earth).

ECGs only approved for installation in luminaires are not assigned to a protection class since protection classes are defined only for end products (such as luminaires) and not for components.

All QUICKTRONIC® units to operate T5/Ø 16 mm-fluorescent lamps FH®...HE and FQ®...FO are, in principle, suitable for operation in protection class I and II, unless otherwise indicated in the latest edition of the Lighting Programme or under www.osram.com/ecg

However, radio interference suppression and temperatures must be checked in each case.

As a general rule, we can say that the thermal properties in open metallic luminaires (typically protection class I luminaires) are normally better than in enclosed plastic luminaires (typically protection class II luminaires) because of the good thermal conductivity of metal (heat sink effect) and better convection possibilities in the luminaire.

3.12 Insulation Distances in Luminaires

The use of luminaires is subject of a series of regulations governing electrical safety (shock protection) and operational reliability in wet, dusty, corrosive, flammable and explosive conditions. European standard EN 60598 applies to the electrical safety of luminaires.

To guarantee the electrical safety of luminaires, special attention must be paid to clearances and tracking distances. These terms are defined as follows in EN 60598-1-11 for the mains terminal of the luminaire:

„Tracking distances at the mains terminal shall be measured between the active parts in the terminals and any exposed metal part. Clearance shall be measured between the incoming mains cable and exposed metal parts (i.e. from the bare end from which the insulation has been stripped the furthest to the metal part that is exposed). On the side of the terminal to which the internal wires are connected, the clearance shall be measured between the active parts and the exposed metal parts.”

For further information please refer to luminaire standard EN 60598.

3.13 Insulation Test

Luminaires must be subjected to insulation and high voltage testing (according to EN 60598, VDE 0711, PM 395). Proceed as follows:

- Input and output terminals of the ECG – except the PE conductor terminal – must be connected conductively with one another.

- Conduct insulation test at 500 VDC; the leakage current should not exceed 0.25 mA.
- Carry out high voltage test at 1.5 kV AC/50 Hz. This voltage must be maintained for 1 s without flash-over (i.e. leakage current < 10 mA).

The following are recommended alternatives for the luminaire manufacturers (PM 333, PM 395):

- 100 % high voltage testing (insulation testing may be omitted) or
- 100 % insulation testing and 1-2% high voltage testing or
- testing by agreement with the testing authority (such as VDE, KEMA, SEMKO)

3.13.1 Dielectric Resistance in Lighting Systems

Dielectric resistance in lighting systems (> 0.5 MΩ) can be measured in accordance with DIN VDE 0100 Part 600 Section 9 between:

- a) The outer conductors (L1, L2, L3) and the protective earth (PE) conductor
- b) The neutral conductor (N) and the protective earth (PE) conductor
- c) The outer conductors (L1, L2, L3) among themselves
- d) The outer conductors (L1, L2, L3) and the neutral conductor (N)

The insulation test is performed at 500 VDC.

3.13.2 Measuring the Dielectric Resistance between N and PE or L and PE

(See picture in Section 3.10)

Tests are performed on new and existing installations. In existing installations the test may be carried out without isolating the luminaire approx. every two or three years.

There must be no electrical connection between the neutral conductor (N) and the PE conductor. In this insulation measurement (500 VDC with respect to PE), the neutral conductor isolating terminal should only be disconnected if mains voltage is disconnected! Make sure the connection is secure before reapplying mains voltage. Failure to observe these instructions may lead to destruction of all the ECGs in the system due to an unbalanced load and a resultant overvoltage.

Recommendation: 500 VDC = max. 1 mA measurement current

Measurement procedure:

- The ECG appears momentarily to have low resistance (charging of the capacitors in the interference suppression filter).
 - The ECG then appears to have high resistance.
- An insulation fault in the lamp circuit does not affect the ECG.

The ECG will not be damaged by insulation tests provided a maximum current of 1 mA is not exceeded (the measuring equipment must be designed as a current source with an internal resistance of 500 kΩ).

Important:

Before using the lighting system, check for correct N conductor connections! While the lighting system is in operation, never interrupt the neutral conductor!

3.13.3 Three-Phase Operation

The proper connection of the N conductor is very important in an installation for even load distribution in a three-phase operation.

The following diagram shows both the correct and the faulty wiring and its possible impact:

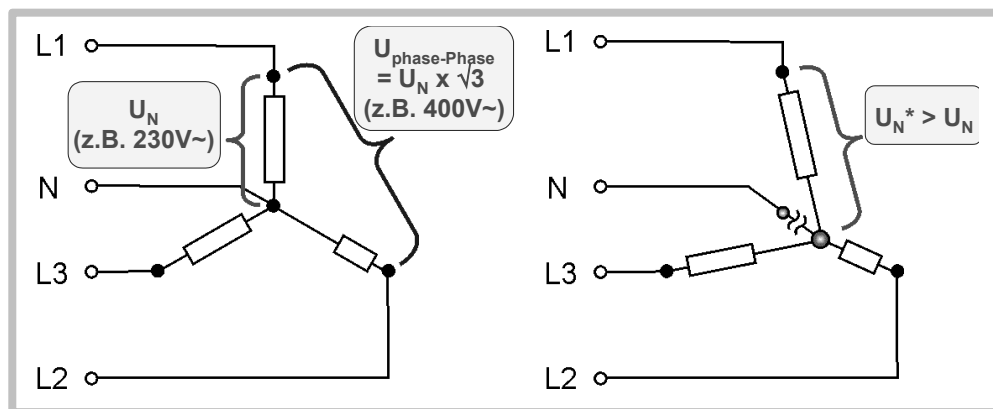

- $U_N^* > U_N$
- Theoretical maximum value:
 $U_N^*_{max} = U_N \times \sqrt{3}$ (= 400 VAC @ $U_N = 230$ VAC)
- In practice:
 $U_N^* < 350$ V in most cases
 (no complete asymmetrical load distribution)

3.13.4 Resistance to Overvoltage for QUICKTRONIC® for T5/Ø 16 mm-Fluorescent Lamps

QUICKTRONIC®-ECG for operation of T5/Ø 16 mm- fluorescent lamps FH®...HE and FQ®...HO have the following resistance to overvoltage:

	Resistance to overvoltage
QUICKTRONIC® INTELLIGENT, QT <i>i</i>	350V → continuous 400V → 48 hours
QT-FH ... CW (30 mm height) QT-FQ ... CW (30 mm height)	300V → continuous 320V → 48 hours 350V → 2 hours
QT-FH ... F/CW (21 mm height) QT-FQ ... F/CW (21 mm height)	300V → continuous 320V → 48 hours 350V → 2 hours

3.14 Inrush Current / Automatic Circuit Breakers

When an ECG is switched on, a starting current pulse of very short duration (< 1 ms) occurs as the storage capacitors responsible for internal power supply charge up. If a large number of ECGs are switched on simultaneously (particularly if they are switched on at peak rated voltage) a starting current will flow that will reduce the recommended number of ECGs per automatic circuit breaker below that which would apply if we were to consider only their rated currents. All switching equipment and protection devices must therefore be selected according to their current carrying capacity.

The values mentioned in Section 7.3 refer solely to the automatic circuit breakers type B from Siemens.

3.15 RCDs / Fault Currents

In the case of ECGs with protective earth (PE) connections, both the high short duration starting current and the small continuous current through the interference suppression capacitors in the ECG can trip the residual current detector (RCD).

The following solutions may be considered:

- Devide the luminaires into three phases and use three-phase RCDs
- Use surge-current-resistant, short-delay
- Use 30 mA RCDs (if possible)

In Section 7.3 are the values for QUICKTRONIC® ECG for operation of T5/Ø 16 mm- fluorescent lamps FH®...HE and FQ®...HO.

3.16 Leakage Current

In protection class I luminaires, the internal HF filter in an ECG with PE conductor connection produces a 50 Hz leakage current through the earth conductor whose value depends on the product type.

This 50 Hz leakage current limits the number of ECGs that can be operated on an RCD.

For all QUICKTRONIC® units to operate T5/Ø 16 mm- fluorescent lamps FH®...HE and FQ®...HO the following applies:

Leakage current < 0.5 mA

3.17 ECGs in Three-Phase Operation

When using electronic control gear in a three-phase operation the following points have to be considered:

1. Check whether the mains voltage is within the application range of the ECG (DC/AC range from 198 V to 254 V).
2. The mains connection on the installation side may only be made to the luminaire terminal. For luminaries or luminaire groups in 3-phase circuits.
3. Make absolutely sure that the neutral conductor is correctly connected to all the ECG-luminaires and that it is making proper contact.
4. Cables may only be disconnected or connected when no voltage is present.
5. For 3x230/240 V supply networks in triangular circuit arrangements, protection by way of common disconnection of the phase conductor is necessary.

Important:

- In new installations the load must not be connected when the insulation resistance is measured with 500 V DC, since according to VDE 0100 T600 Section 9 the test voltage is also applied between the neutral conductor (N) and all three external lines (L1, L2, L3). In existing installations it is sufficient to carry out an insulation test between the external lines (L1, L2, L3) and the protective earth without disconnecting the loads. The neutral conductor (N) and the protective earth (PE) may not be electrically connected in any way when this is done. For this insulation measurement (500 V DC to earth) the neutral conductor disconnection terminal may only be opened with the mains voltage switched off!

- Before the equipment is put into operation, make sure that the N conductor is correctly connected!
- During operation do not disconnect the N conductor on its own or first!

Luminaires or luminaire groups can also be wired in 3-phase operation with a common N conductor (neutral conductor) as seen in the diagram **3.14.2**

If the common neutral conductor is interrupted in a 3-phase star configuration and voltage is present, then luminaires or groups of luminaires operated with ECG may be exposed to unacceptably high voltages and the ECG itself may be destroyed.

See also Section **3.14.3** for high voltage resistance of different QUICKTRONIC[®] types to operate T5/Ø 16 mm- fluorescent lamps FH[®] ...HE and FQ[®] ...HO.

4. Lamp Wiring

4.1 h = 21 mm

4.1.1 QUICKTRONIC® INTELLIGENT 1-lamp version

QUICKTRONIC® INTELLIGENT
QT-1x35/49/80

lamp	I_n (A)	γ	lamp	I_n (A)	γ	lamp	I_n (A)	γ
1xHE15W	0,08	0,99	1xHO40W	0,34	0,99	1xDL55W	0,30	0,99
1xHE21W	0,11	0,97	1xHO60W	0,38	0,98	1xDL80W	0,35	0,99
1xHE28W	0,15	0,96				1xPC55W	0,27	0,99
1xHE35W	0,18	0,96						

I_n (A) = 0,20...50
 U_n (V) = 220-240
 L_n (Hz) = 0,50-60
 EOL
 ENEC
 CE
 OSRAM
 EEI = A2
 U-OUT = 330V
 Temp-Test $t_c = 70$ C max
 Range of application: AC/DC 230V to 240V
 Range of lamp voltage: 110 to 240V
 Can be used for Ambulux per section class 1 and II
 Suitable for emergency installation acc. to EN 18226
 Starting time 1 sec.

4.1.2 QUICKTRONIC® INTELLIGENT 2-lamp version

QUICKTRONIC® INTELLIGENT
QT-FQ 2x35

Range of application: AC/DC 230V to 240V
 Range of lamp voltage: 110 to 240V
 Can be used for Ambulux per section class 1 and II
 Suitable for emergency installation acc. to EN 18226
 Starting time 1 sec.

4.1.3 QT-FH MULTIWATT F/CW

QUICKTRONIC® MULTIWATT
QT-FH 1x14-35/230-240 F/CW

Range of application: AC/DC 230V to 240V
 Range of lamp voltage: 110 to 240V
 Can be used for Ambulux per section class 1 and II
 Suitable for emergency installation acc. to EN 18226
 Starting time 1 sec.

4.1.4 QT-FQ F/CW 1-lamp version

QUICKTRONIC® F/CW
QT-FQ 1x24-35/230-240 F/CW

Range of application: AC/DC 230V to 240V
 Range of lamp voltage: 110 to 240V
 Can be used for Ambulux per section class 1 and II
 Suitable for emergency installation acc. to EN 18226
 Starting time 1 sec.

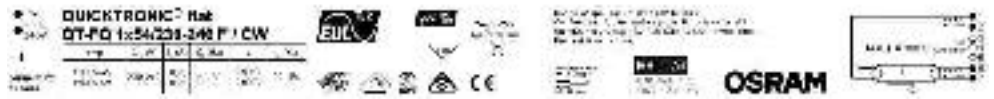

4.1.5 QT-FQ F/CW
2-lamp version



4.2 h= 30 mm
4.2.1 QT-FH MULTIWATT
1- and 2-lamp version

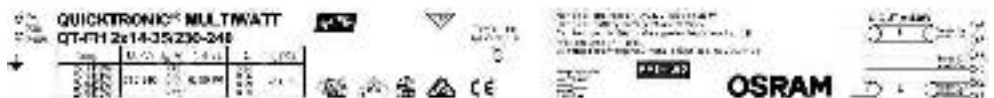

4.2.2 QT-FH
3- and 4-lamp version

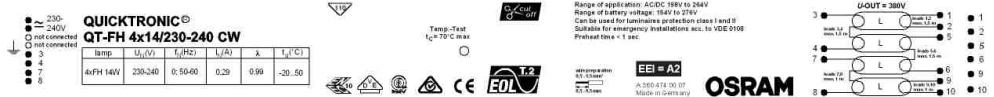

5. QUICKTRONIC® INTELLIGENT

5.1 Definition INTELLIGENT



Electronic Control Gear of OSRAM labelled with this sign are realised in μ Controller technology.

The ECG to operate T5/ \varnothing 16 mm-fluorescent lamps in equal length detect the lamps and operate them with rated data.

Thanks to this different lamp wattages and types can be operated with one ECG type only.

5.2 Lamp Detection as Fundamental Advantage

In the past, T5/ \varnothing 16 mm-fluorescent lamp systems have been divided in two different families, FQ®...HO and FH®...HE.

With HO-fluorescent lamp systems high lumen packages (i.e. HO 80 W with up to 7.000 lm) can be realized. FH®...HE fluorescent lamp systems are not very powerful but extremely efficient (luminous efficacy up to 104 lm/W). Both lamp families have the same lamp lengths, however, different wattages (see Section 2.2) which, up to now, required always a dedicated ECG. This is now a thing of the past due to QT_i and their possibility to combine T5 fluorescent lamps of equal length.

These T5 lamp types can be operated with just one QT_i:

FH® 14W HE + FQ® 24W HO	(549 mm)
FH® 21W HE + FQ® 39W HO	(849 mm)
FH® 28W HE + FQ® 54W HO	(1,149 mm)
FH® 35W HE + FQ® 49 W HO + FQ® 80W HO	(1,449 mm)

5.3 QT_i – the High-tech ECG

As QUICKTRONIC® INTELLIGENT automatically detect T5/ \varnothing 16mm fluorescent lamps and operate them according to their optimal electric parameters, lamps reach their maximum lamp life. As a result, lamp replacement intervals can be significantly extended.

Due to the minimal losses of QUICKTRONIC® INTELLIGENT the energy balance of T5 systems is optimised. The proven OSRAM cut-off technology (turning off the electrode preheating after the lamp started) contributes to the improved energy savings. For the first time, this is also possible for dimmable ECG QT_i ... DIM thanks to QUICKTRONIC® INTELLIGENT technology.

5.4 QT_i – Advantages

QUICKTRONIC® INTELLIGENT QT_i reduce not only the cost of illumination, they also increase the productivity

- Less number of fixture types in the production process (for example only one basic type for 35/49/80 Watt)
- Less complexity in manufacturing through:
 - identical wiring for dimmable and non dimmable QT_i
 - identical case dimensions (1- or 2-lamp versions)
 - cw-terminal (combi wiring) for mechanical and manual wiring
- New design options for super flat T5 luminaires due to minimal height of only 21 mm for QT_i.

QUICKTRONIC® INTELLIGENT, QT_i also reduce the cost through:

- Less stock keeping of luminaires (approx. 50 % less types)
- Change of lumen output possible at any time simply by replacing the lamp
- No wrong lamp types by mistake with effect on the lamp life
- Lower number of luminaires to be stocked at the user's facility

5.5 QTi – Practically Applied

In industrial applications different minimum illumination levels have to be applied according to law. Up to now, this required separate luminaire types. From now on, this requirement can be fulfilled with only one basic luminaire type fitted with different lamps.

For example:

Workplace for technical drawing 1000 Lux, $R_a > 80$ → FQ® 80W HO

- Workplace for mechanical manufacturing 500 Lux, $R_a > 80$ → FQ® 49W HO
- Factory traffic 300 Lux, $R_a > 80$ → FH® 35W HE

With the new family QUICKTRONIC® INTELLIGENT, QTi, OSRAM contributes to reduce the cost of our business partners in terms of logistics or to more flexibility in lighting installations.

5.6 Technical Specialties for non-dimmable QTi

5.6.1 Inrush current limitation

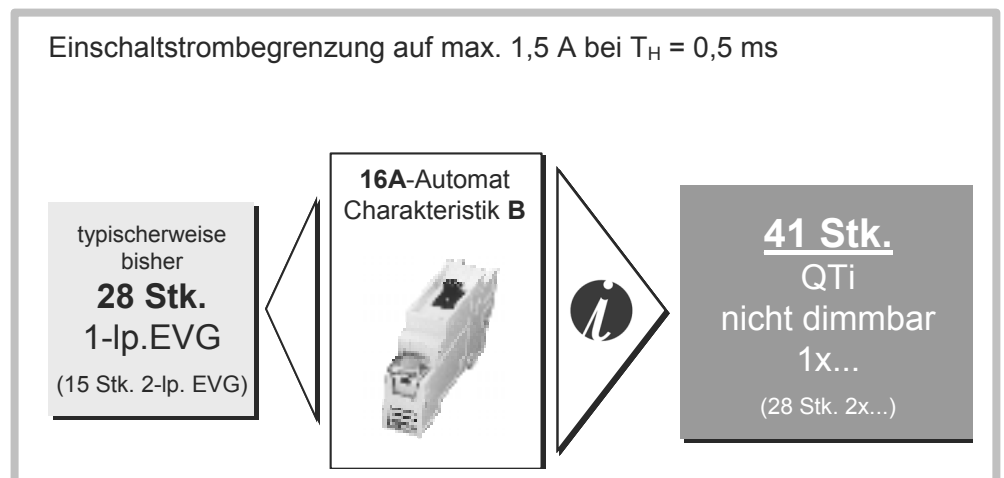

The new micro-controller technology allows alternative circuits in the input section of an electronic control gear. Therefore it is now possible to equip non-dimmable versions with a limitation of the starting current.

By limiting the starting currents almost twice as many QTi units can be operated on a single automatic circuit breaker than compared to single-wattage ECGs.

This product feature reduces the wiring efforts in lighting installations.

See Section 7.3 for specific values of starting currents.

5.6.2 Resistance to Overvoltage up to 400V

Usually, electronic control gear work with input voltages between 220 V and 240 V in a standard three-phase installation. If the contact of the neutral conductor is missing or faulty, this value can rise – depending on the load distribution – up to a maximum value of

$$\sqrt{2} * 230 \text{ V} = 400 \text{ V}$$

The resistance to overvoltage of non-dimmable QT*i* is 300 V for the duration of two hours. Depending on the load distribution in an installation normally values between 280 V and 400 V are achieved. To integrate an optical warning signal without additional stress of components QUICKTRONIC® INTELLIGENT units shut down the lamps at voltages greater than 290 V. At the input of the ECG the input voltage is measured in an interval of ms and the lamp is automatically restarted once the voltage drops below 290 V, thus avoiding to influence the lamp life.

5.6.3 Lamp-ECG-Combination

5.6.3.1 Straight Fluorescent types

Besides the combination of T5/Ø16mm-fluorescent lamps of equal length additional fluorescent lamps can be operated in combination with QT*i*. All lamp combinations have an ENEC approval, which means that the fluorescent lamps are operated without loss of lumens compared to single-wattage types.

Combinations with FH, FQ, T8



	FH HE14 W	FH HE21 W	FH HE28 W	FH HE35 W	FQ HO24 W	FQ HO39 W	FQ HO49 W	FQ HO54 W	FQ HO80 W	L 18 W	L 30 W	L 36 W	L 58 W	L 70 W
QT<i>i</i> 1x14/24/21/39	☐	☐	☐	☐	☐	☐				☐	☐	☐		
QT<i>i</i> 1x28/54	☐	☐	☐	☐				☐					☐	☐
QT<i>i</i> 1x35/49/80	☐	☐	☐	☐			☐		☐					
QT<i>i</i> 2x14/24/21/39	☐	☐	☐	☐	☐	☐				☐	☐	☐		
QT<i>i</i> 2x28/54	☐	☐	☐	☐				☐					☐	
QT<i>i</i> 2x35/49	☐	☐	☐	☐			☐							

5.6.3.2 Compact and Circular lamp types

Combinations with DL, DF, FC



	DL 18 W	DL 24 W	DL 36 W	DL 40 W	DL 55 W	DL 80 W	DF 18 W	DF 24 W	DF 36 W	FC 22 W	FC 40 W	FC 55 W
QTi 1x14/24/21/39	<input type="checkbox"/>	<input type="checkbox"/>	<input type="checkbox"/>	<input type="checkbox"/>			<input type="checkbox"/>	<input type="checkbox"/>	<input type="checkbox"/>	<input type="checkbox"/>	<input type="checkbox"/>	
QTi 1x28/54												
QTi 1x35/49/80					<input type="checkbox"/>	<input type="checkbox"/>						<input type="checkbox"/>
QTi 2x14/24/21/39	<input type="checkbox"/>	<input type="checkbox"/>	<input type="checkbox"/>	<input type="checkbox"/>			<input type="checkbox"/>	<input type="checkbox"/>	<input type="checkbox"/>	<input type="checkbox"/>	<input type="checkbox"/>	
QTi 2x28/54												
QTi 2x35/49												

5.6.4 Wiring

All single-lamp or two-lamp versions of QTi have identical wiring no matter if dimmable with DALI-interface, dimmable with 1-10 V-interface or non-dimmable.

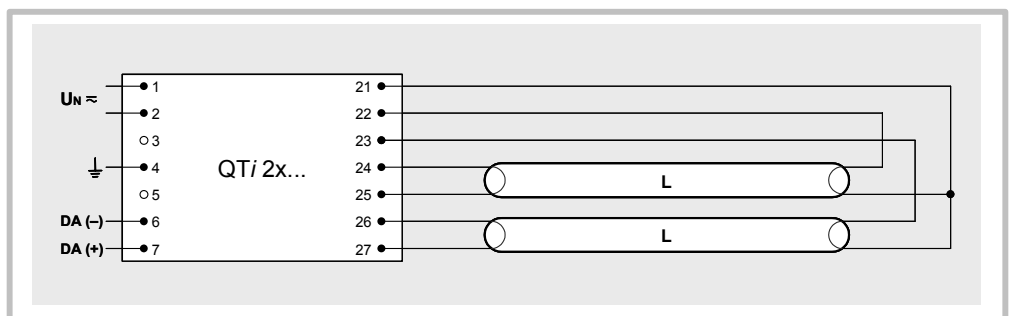
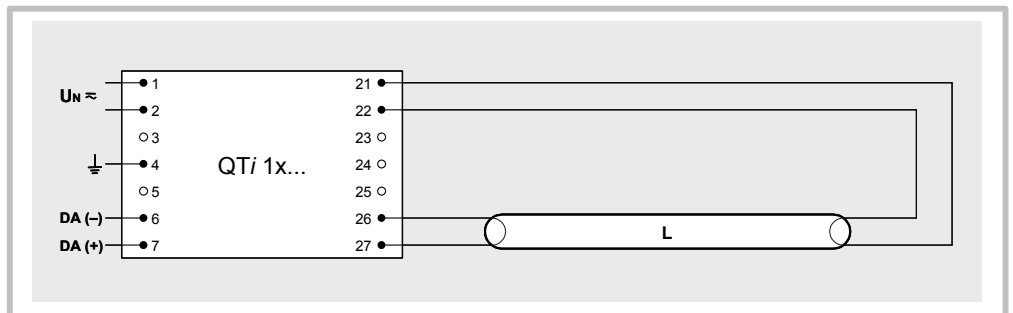

Cables which should be kept short are always applied to the terminals with the highest numbers.
For absolute cable lengths see Section 7.2.

1-lamp version: #26 and 27
2-lamp version: #24, 25, 26 and 27

This product feature allows the pre-production of luminaires with cable harnesses.

5.6.5 Dimensions

Harmonised and identical dimensions for all 1-lamp and 2-lamp QT*i* is another product feature increasing the flexibility in luminaire design and production.

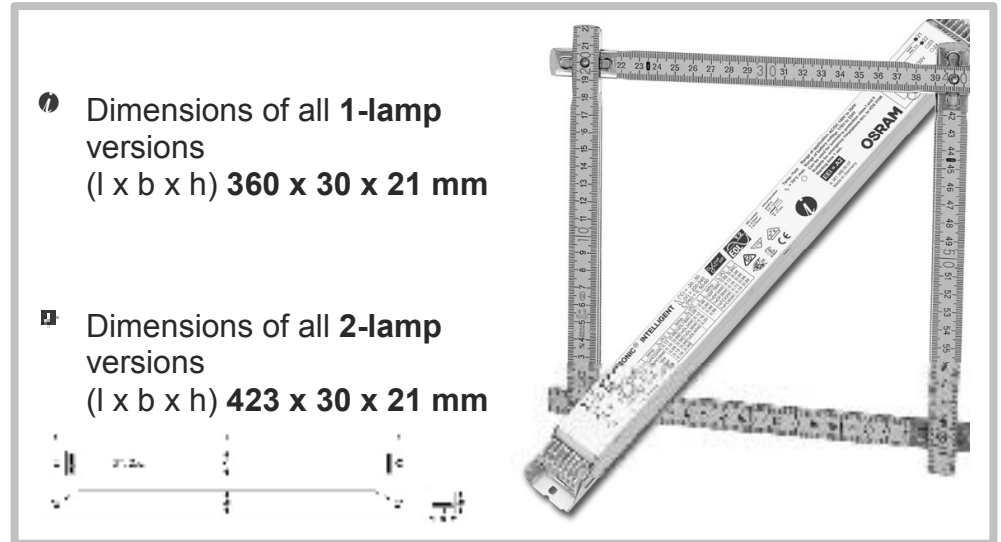

5.7 FAQ

- Can FH[®]...HE and FQ[®]...HO- fluorescent lamps be operated together with a 2-lamp QT*i*?

No, because in this case both fluorescent lamps are not operated at their rated data. The ECG will not be damaged, however a significant difference in the luminous flux of both lamps can be seen.

- Will the lamp detection be repeated with every restart of the ECG?

Yes, a the clear lamp detection with every restart is guaranteed. The fluorescent lamps start within 1 second.

- Can QT*i* also be operated in emergency lighting installation at DC voltage?

Yes, QT*i* are suitable for the operation with DC voltage.

- Does the entire approval have to be done for all lamp wattages?

No, according to an international testing institute the entire approval must only be carried out for the system with the highest wattage. All other T5/∅ 16 mm-fluorescent lamp combinations are subject to a reduced testing procedure.

However, we recommend to discuss these details with the according national approval authorities.

6. Special Applications

6.1 Outdoor Application

If you intend using electronic control gear for T5/Ø 16 mm- fluorescent lamps in outdoor luminaires, it is important to remember that depending on the design of the luminaire, it may be exposed to moisture and humidity.

The level of protection of the luminaire (IP ... according to DIN 40050/IEC 529) determines whether standard or special ECG have to be installed.

- 1) In luminaires of ingress protection type „5“ (protected against water jets: IP 65 for example) standard ECG can be used since dampness cannot penetrate this type of luminaire. So there is no risk of the ECG being corroded.
- 2) In the case of luminaires of protection type „3“ (protected against splash water, IP 43 for example), it is possible that water droplets will penetrate and cause corrosion. We therefore recommend using a protective housing (OUTKIT) over the ECGs for these luminaires. When using QUICKTRONIC® of 21 mm height in combination with OUTKIT (see Section 6.1.2) special attention should be paid to the proper strain relief of the ECG in the OUTKIT cases.

Typical applications include lighting systems for car washes, petrol stations, outdoor advertising, swimming pools etc.

For these applications we recommend to use the ECG in combination with OUTKIT.

6.1.1 Installation Instructions

In addition to general installation and wiring instructions (**Section 3**) the following information is important:

- The mains connection terminals on the ECGs should point downwards. In other words, the control gear should be installed vertically or upside down with the base of the ECG uppermost, otherwise horizontally with a slight incline (5 to 10°). This will prevent condensate from collecting inside the unit and causing short-circuits on the printed circuit board and tripping the RCD as a result of leakage currents.
- All ECG terminals that are not protected by vertical or upside down installation should be covered by arched metal plates or plastics (better with regards to corrosion) so that spray water and condensate cannot drip into the terminals and therefore into the ECG.
- Place ECGs on spacers to protect them from dripping water/condensation.
- To prevent water entering the control gear through the terminals along the incoming or outgoing cables, it is best to bend the cables ahead of the terminals (to provide a water pocket or drip point). To ensure success, the lowest point of the kink should lie below the level of the terminal inlet.
- A small opening at the lowest point on the luminaire is also recommended so that condensation can escape. However, this opening should be protected so that rain and spray cannot enter.

In summary, we can say that the ECG should be installed in such a way that spray, water drops and condensation cannot enter the ECG and that moisture and condenses inside the ECG can run out.

An ECG can withstand condensation for short periods but long-term exposure to moisture should be avoided. The ECG must be operated for at least 30 minutes per day so that condensation inside the ECG can evaporate.

The luminaire casing should not be hermetically sealed. Instead, it should be ventilated so that the condensate that forms during the cool-down period as a result of the change in temperature (a luminaire is switched on, say, at $-10\text{ }^{\circ}\text{C}$, warms up during operation to $+30\text{ }^{\circ}\text{C}$ and then cools down again to $-10\text{ }^{\circ}\text{C}$ after it has been switched off) is not trapped inside the unit and can evaporate safely.

6.1.2 OUTKIT

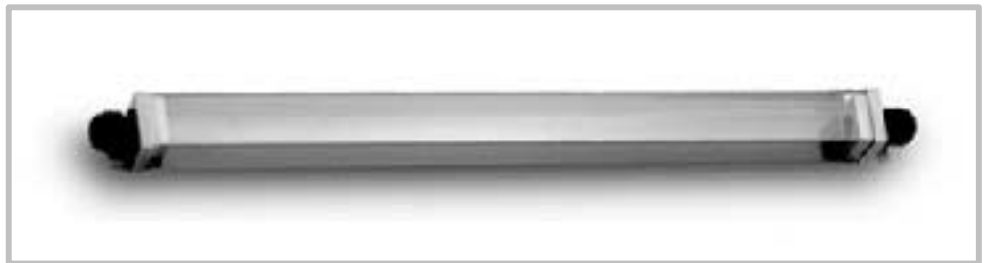

Technical Data	OUT KIT Short	OUT KIT Long
Voltage Range	198 V to 264 V	198 V to 264 V
Temperature Range	$-25\text{ }^{\circ}\text{C}$ to $50\text{ }^{\circ}\text{C}$	$-25\text{ }^{\circ}\text{C}$ to $50\text{ }^{\circ}\text{C}$
Lenth	485 mm	550 mm
Height	38 mm	38 mm
Distance mouting whole a	452 mm	517 mm
Standard pack [pcs.]	20	20
OUT KIT Short for ECG with $l = 360\text{ mm}$		
OUT KIT Long for ECG with $l = 423\text{ mm}$		
Permitted cable diameter for use of standard cables:		
<ul style="list-style-type: none"> - 2-3 mm for the material attached for 2,3 and 4 wires - 2-2,7 mm for the material attached for 7 wires 		

6.2 T5-ECG in Sound Studios

If electronic control gear for T5/ \varnothing 16 mm-fluorescent lamps are to be used in areas in which noise and electromagnetic interference (see also **Section 2.7**) are important factors there are special requirements that have to be met when installing the ECG and the luminaires.

6.2.1 Noise and how to avoid it

Generally speaking, noise is generated in electronic circuits as a „hum“ (at 50 Hz or 100 Hz) or as higher frequency interference in inductances (chokes, transformers) and capacitors.

Compared with conventional control gear (chokes), electronic controlgear with their high-frequency mode of operation (in which inductance values are much lower) generate appreciably lower noise levels and are a problem only in highly sensitive environments such as sound studios for CD quality recordings. The fully electronic control gear for T5/ \varnothing 16 mm-fluorescent lamps offered by OSRAM is much quieter than conventional ballasts.

T5/ \varnothing 16 mm-fluorescent lamps can only be operated by electronic

control gear. Therefore, a direct comparison with conventional control gear (chokes) does not make sense.

In T5 luminaires, the electronic control gear functions as a vibration source and is capable of exciting adjacent metallic or plastic components so that they act as resonators, amplifying the actual noise considerably and help to spread it out.

To avoid this, especially the recommended minimum distance between two T5/Ø 16 mm- fluorescent lamps has to be respected so that no noise can be generated due to physical contact.



1. For high luminaire efficiency the distance should be at least 48 mm between the two lamps (approximately two fingers should fit between the lamps)
2. When designing the luminaire for minimum distance the maximum recommended base temperature of 120 °C may never be exceeded.

6.2.2 Recommended minimum distance between lamp and reflector

The maximum recommended base temperature of 120 °C may never be exceeded.

A distance of less than 3 mm between lamp and reflector can result in generation of noise even in luminaires with non-dimmable ECGs.

At a distance of less than 6 mm between lamp and reflector the leakage current of the dimmed lamps 35 W, 49 W and 80 W causes visible differences in brightness between the ends of the lamps. In addition, the radio interference suppression is getting worse.

OSRAM recommendation:

In general, OSRAM recommends to keep a minimum distance of **6 mm** between lamp and reflector. In certain cases (unfavourable capacitive interference) the minimum distance should be even greater.

To develop luminaires that are as quiet as possible, it is therefore essential to insulate the control gear and chassis or luminaire support. In other words, there should be clearance below the ECG with the ECG mounted on point supports on the luminaire chassis or on rubber absorbers as used for conventional ballasts. Under certain circumstances, this type of mounting may, however, lead to thermal problems since the best way to dissipate the power loss to the environment is to have the ECG in full contact with the chassis.

Solving this problem with an appropriate housing design and/or type of installation for the luminaire (forced cooling, increased convection effect) has a further advantage in reducing the interference noise level and should therefore seriously considered.

Experiments have shown that the amount of noise generated is closely linked to the operating temperature of the electronic control gear. This is a particularly important factor if the unit has been installed in accordance with the recommendations given above. In extreme cases, it will not be possible to work without additional heat sink.

In addition, the noise level increases disproportionately as the temperature of the ECG rises. It is therefore best to operate the control gear at a temperature below the maximum recommended value. In practice, this means that the amount of noise generated is less, the lower the measuring point temperature t_c . A combination of acoustic insulation of the ECG and reduced operating temperature represents the best technical solution.

In general, the following applies:

Electronic control gear for T5/Ø 16 mm-fluorescent lamps FH[®]...HE and FQ[®]...HO are so quiet that even in very quiet surroundings they cannot be discerned by the human ear. They are therefore ideal for sound-sensitive areas such as radio studios with CD quality recordings. If necessary, random samples should be used to determine whether, given the local parameters (volume of the studio, reverberation time and number of ECGs), insulation as described above is needed from an acoustic point of view or whether standard products could be used.

6.3 Treatment Rooms, Operating Rooms

In rooms used for medical treatment electrodes may be placed on a patient's body to obtain electro-cardiogram or electro-encephalogram recordings. To eliminate interference from magnetic fields, DIN VDE 0107 defines the maximum recommended inductance strengths. Luminaires fitted with QUICKTRONIC[®] control gear easily fall within this limit values at distances of 0.75 m and greater.

Because of their magnetic field strengths, conventional control gear that cannot be used for T5/Ø 16 mm-fluorescent lamps but for T8/Ø 26 mm tubes are often not suitable and have to be placed at least 3 m away.

6.3.1 Electromagnetic Interference

Fluorescent lamps are not point light sources and cannot be adequately focused, which means they are not considered suitable to light operating tables. Dichroic halogen lamps are used almost exclusively. But even the room lighting has to meet very stringent requirements in terms of radiated magnetic fields. Sensitive patient monitoring systems in the operating room and intensive care wards must not be exposed to leakage magnetic fields.

It is necessary to comply with the maximum recommended interference levels and minimum installation distances for luminaires as defined in VDE 0107/6.81. Important information on this subject can be found in **Section 3.2**, electromagnetic compatibility.

Whereas conventional control gear had to be installed separately from the luminaire in a central switch cabinet far enough away from the treatment area, ECGs for T5/Ø 16 mm fluorescent lamps can, in most cases, be installed directly in the luminaire without any problem. The actual

interference levels generated by luminaires fitted with ECGs are generally lower than those generated by the connecting cables between the luminaire and the choke for a conventional separate T8/Ø 26 mm arrangement.

The electrical safety requirements correspond to those for installations in humid locations. In other word, protection class II luminaires should be used. For precise information on the minimum level of protection for the luminaire see DIN 40050/IEC 529.

Because of their low field strengths ECGs are unlikely to affect electronic equipment. There has been no known incidence of a heart pacemaker being affected.

6.3.2 Interference from Infrared Transmission Equipment

Fluorescent lamps emit energy in wavelength bands that are also used for infrared transmission. These emissions cannot be changed at the lamp. Since IR receivers are often not selective and operate with wide wavebands, the IR equipment may be triggered inadvertently if light from the lighting system enters the receiver. The light emitted from the fluorescent lamp is modulated at twice the operating frequency (40 kHz to 120 kHz). Interference may occur if the useful signal also operates in this frequency range.

Interference is likely in cases in which the useful signal falls in the frequency range of the light emitted from the fluorescent lamp. Operating at higher frequencies (400 to 1500 kHz) or using optical filters in front of the infrared receivers (absorption filters) may help. Shielding the infrared receiver from direct light (with a tube, for example) may also help.

The carried signal for sound transmission used to be around 95 kHz or higher, which meant that the 3rd, 5th and 7th harmonics of the ECG operating frequency ranges (30 to 60 kHz in normal operation and up to 120 kHz in dimmer mode) led to considerable interference in transmission. Headphone manufacturers shifted to higher frequencies, such as 2,3 MHz and 2,8 MHz, to remedy the problem.

For simultaneous interpreting systems, which also operate in the 95 to 250 kHz frequency range, we recommend not to use the first six transmission channels, particularly channel 1, because these are affected by the harmonics of the basic ECG frequencies.

6.4 Electronic Tagging

Many department stores and shops now use electronic tagging systems to protect their merchandise (such as clothes, CDs, drugstore articles etc.) against theft. These systems typically operate with resonance frequencies in the kHz-range.

In certain circumstances these systems may malfunction if the operating frequency is between 30 kHz and 130 kHz. It may be possible to eliminate the problem by increasing the distance between the luminaire and the transmitter/receiver.

6.5 Emergency Lighting

T5-luminaires with QUICKTRONIC® from OSRAM can be operated on either AC or DC voltage. This means that the same luminaires can be used for both general lighting and emergency lighting in an easy and cost-effective way. Especially safety lighting from installations with high illuminances (i.e. in workplaces with high risks) can be realised

economically due to the high luminous efficacy of T5/Ø 16 mm-fluorescent lamps operated with QUICKTRONIC® control gear.

The following electro-technical regulations apply to emergency and safety lighting systems installed in Germany:

VDE 0100	Regulations governing the installation of power systems with rated voltages up to 1000 V
VDE 0107	Installing and testing electrical installations in medical rooms
VDE 0108	Installing and operating power systems in buildings for gatherings of people and safety lighting at work
VDE 0165	Installing electrical systems in hazardous areas
VDE 0510	Regulations governing accumulators and battery systems

In addition, there are various lighting standards that have to be observed. In view of the number involved, we have selected just a couple by way of example. The full list can be obtained from Beuth verlag (Publishers) in Berlin.

Lighting requirements for emergency lighting are included in EN 1838. The classification of EN 1838 is in safety lighting and alternative lighting whereas particular importance is in safety lighting.

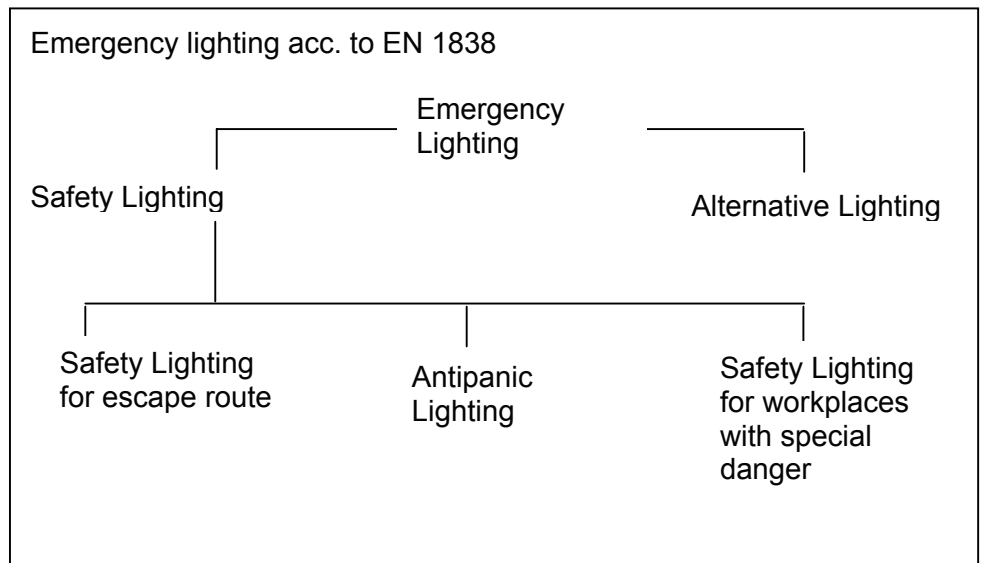

Beside the illuminance (lx) the switch-on delay is a very important criterion that covers ECG (time for ignition) and lamp (starting behaviour).

6.5.1 Different criteria for lighting

	Safety lighting for escape route	Antipanic Lighting	Safety Lighting for workplaces with special danger
Illuminance E_{min}	1 lx	> 0,5 lx horizontal on the ground	10 % of the maintenance value of illuminance absolutely: 15 lx
Switch-on delay	50 % of the required illuminance within 5 s 100 % within 60 s	50 % of the required illuminance within 5 s 100 % within 60 s	0,5 s immediately specified value (10 %) has to be achieved

DIN VDE 0108 includes further information in addition to EN 1838.

In addition to the switch-over times of Electronic Control Gear to operate T5/Ø 16 mm fluorescent lamps , mentioned within the next sections, the switch-over time of the relays have to be considered. These data are available in the technical relay data.

6.5.1.1 Switch-over time for QT_i – h=21 mm

Lampstart	Preheat
Ignition time for a) Cold lamp (Stand-by mode) b) warm lamp (i.e.short term interruption of voltage)	< 1 sec. < 0.5 sec.

6.5.1.2 Switch-over time for QT-FH...CW – h=30 mm

Lampstart	Preheat
Ignition time for a) Cold lamp (Stand-by mode) b) warm lamp (i.e.short term interruption of voltage)	< 2 sec. < 0.5 sec.

6.5.1.3 Switch-over time for QT-FQ...CW – h=30 mm

Lampstart	Preheat
Ignition time for a) Cold lamp (Stand-by mode) b) warm lamp (i.e.short term interruption of voltage)	< 0.5 sec. < 0.5 sec.

6.5.1.4 Switch-over time for QT-...F/CW – h=21 mm

Lampstart	Preheat
Ignition time for a) Cold lamp (Stand-by mode) b) warm lamp (i.e.short term interruption of voltage)	< 0.5 sec. < 0.5 sec.

6.5.2 Wiring diagrams for emergency lighting units

Exemplary wiring diagrams for emergency lighting units

Subject to change without any notes

OSRAM cannot assume warranty for engineering change of the emergency lighting units.

**6.5.2.1 Wiring diagram
QT-FH 3x14 CW with
emergency lighting
component from
BAG**

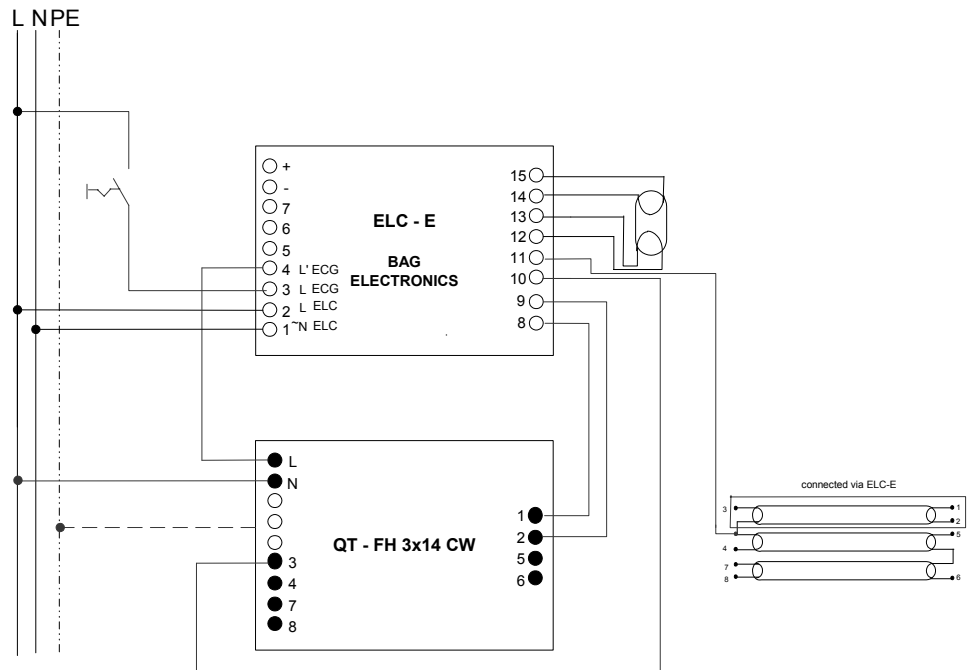

**6.5.2.2 Wiring diagram
QT-FH 4x14 CW with
emergency lighting
component from
BAG**

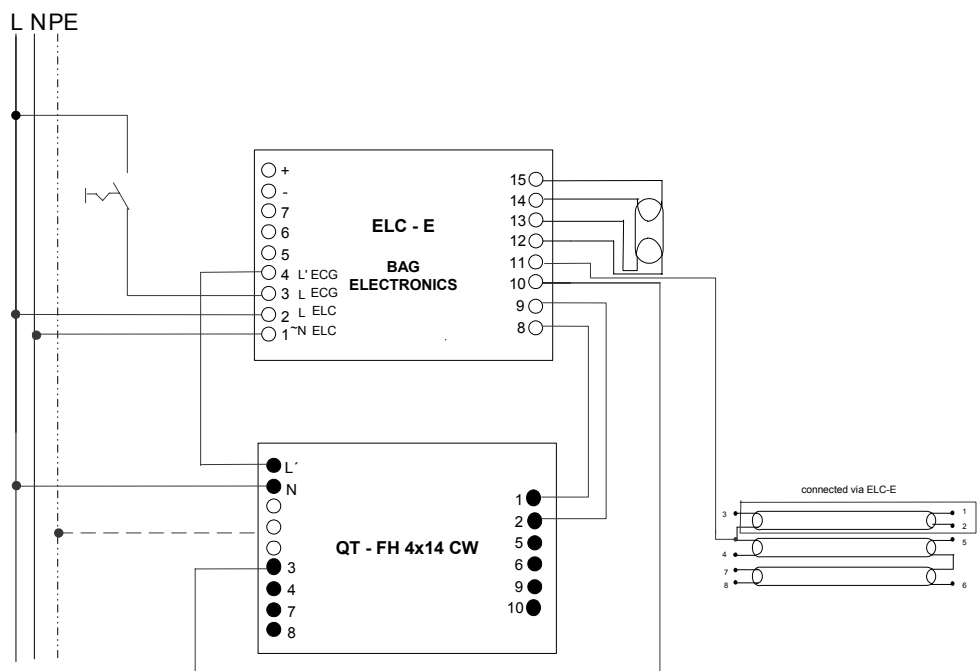

**6.5.2.3 Wiring diagram
QT-FH 3x14 CW with
emergency lighting
component from
OMNITRONIX**

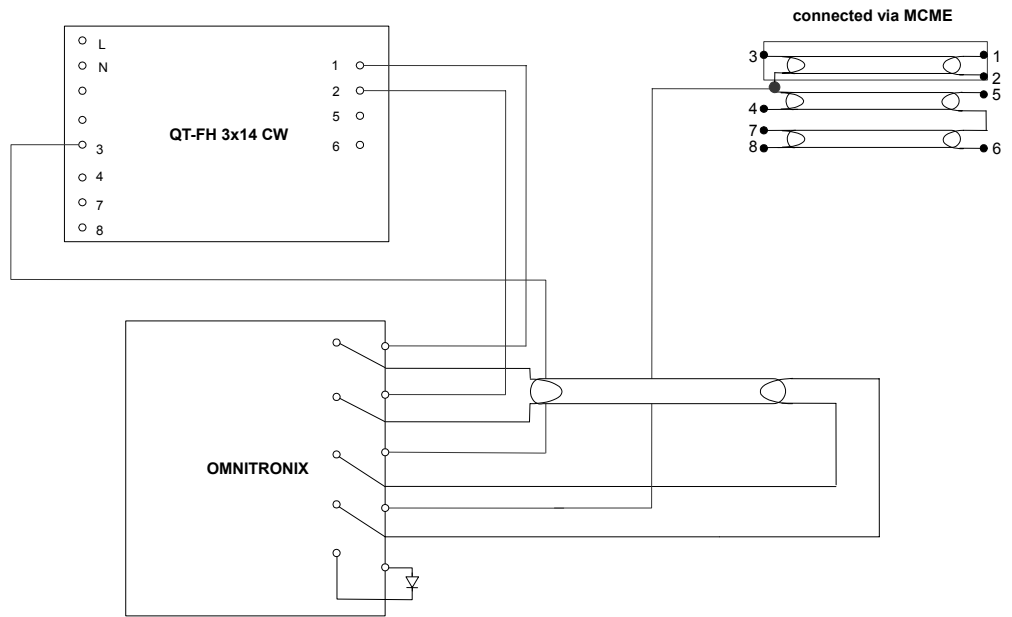

**6.5.2.4 Wiring diagram
QT-FH 4x14 CW with
emergency lighting
component from
OMNITRONIX**

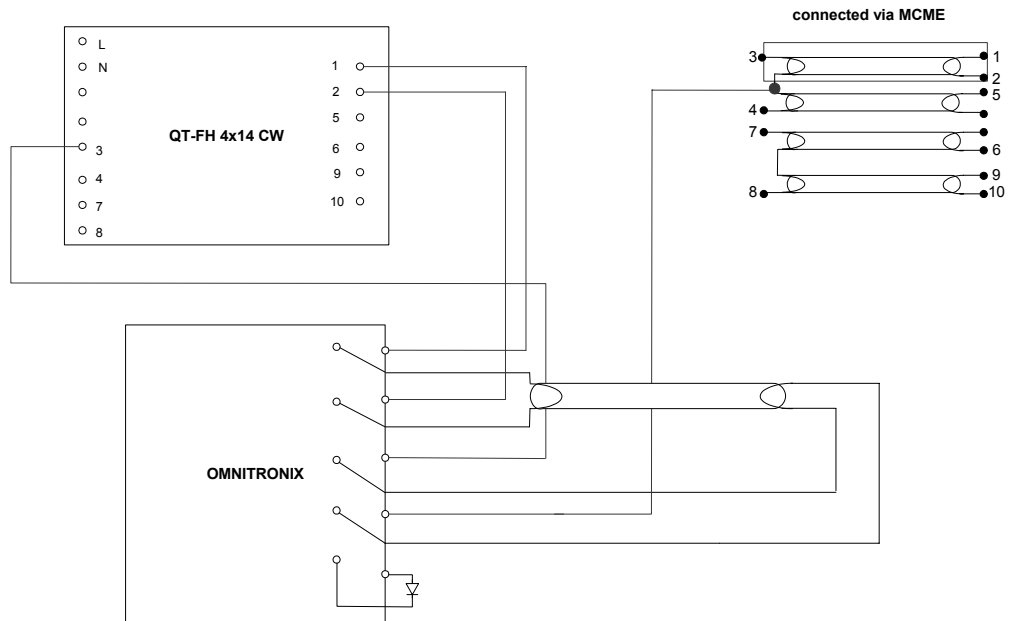

6.6 DC supply

Luminaires for emergency lighting are switched to battery supply only in the event of a power failure. In mains operation, the luminaires are powered by the normal supply. The mains and emergency lighting switchover arrangement must reliably separate mains operation from emergency lighting operation; it must be a break-before-make arrangement.

A deep discharge protection system must be provided for battery systems. This effectively prevents the batteries discharging too much and suffering

damage as a result and also prevents possible damage to the electronic control gear.

General

Switchover from mains supply to emergency supply and vice versa must take place in a break-before-make arrangement (See **Section 6.5**). In this discrete switching sequence there is a period – the length of which depends on the design of the emergency monitoring system – in which current does not flow or at least the supply voltage falls considerably below its minimum recommended value. These switching times must comply with the limits already mentioned in DIN 5035.

In accordance with DIN VDE 0108, the battery units must be designed for rated operation of at least 3 hours. If the ECG is supplied with a rectified AC voltage, this voltage should have as small a residual ripple as possible. The AC voltage component must be less than 5 %.

If changeover units are used (emergency lighting fixtures with internal switching) which supply the lamp directly from an emergency supply and interrupt the system circuit between the ECG and the lamp, the following must be observed:

- Changeover or disconnection of the lamps from the ECG to the external unit must be on all terminals
- When switching back from the external supply to ECG operation, the lamp(s) must first be connected at all terminals to the ECG before the ECG is supplied with power again (for example by using a time delay relay), otherwise the shutdown mechanism in the ECG will operate.
- Many of these emergency lighting units available on the market do not comply with the normal operating conditions for the lamps and therefore damage them. In such cases, OSRAM cannot guarantee the life of the lamps.

6.7 Portable Luminaires

Portable ECG luminaires of protection class I (i.e. cable and plug with earth terminals), require a fuse in both the L conductor and on the N conductors of the mains supply. If VDE approval documents for ECGs state “for permanently installed luminaires” then only the L side is fuse-protected. The N side must be fused in the luminaire if the ECG is to be used also suitable for portable luminaires.

The additional fuse on the N side must be designed for mains voltage, suitable for the system input current and be of the “anti-surge” type.

All OSRAM QUICKTRONIC® ECG for T5/∅ 16 mm- fluorescent lamps are equipped with two internal fuses on the circuit board so that there is no need for additional measures as described above.

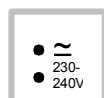

The units are generally labelled with L and N and not with the symbol „≈“ for AC voltage.

6.8 Mix-up of FH®- and FQ®-Fluorescent

Except QUICKTRONIC® INTELLIGENT, QT_i, all other ECGs for T5/∅ 16 mm- fluorescent lamps can only operate the according FH®...HE-

Lamps

or FQ® ...HO-lamp in one length.

If there is a mix-up of fluorescent lamps in the luminaire, this can cause problems.

Effects on the system:

The lamps will generally be started. However, there will be lamp blackening and early failure after a short period of time and (lamp life much less than 1000 hours).

The ECG will not be damaged at any time.

We recommend to label the reflector of the T5-luminaire with a small sticker showing the exact lamp description.

7. Appendix

7.1 Overview of Maximum Cable Lengths

The following tables give an overview of the maximum cable lengths of QUICKTRONIC® ECGs for T5Ø 16 mm-fluorescent lamps FH®...HE and FQ®...HO.

The sequence of fixing the wires to the terminals goes from the upper right downwards.

7.1.1 QUICKTRONIC® INTELLIGENT

ECG-type	Sequence	PIN 21	PIN 22	PIN 23	PIN 24	PIN 25	PIN 26	PIN 27
QTi 1x14/24/21/39	21-27	2	2				1	1
QTi 1x28/54	21-27	2	2				1	1
QTi 1x35/49/80	21-27	2	2				1	1
QTi 2x14/24/21/39	21-27	2	2	2	1	1	1	1
QTi 2x28/54	21-27	2	2	2	1	1	1	1
QTi 2x35/49	21-27							

7.1.2 QT-FH MULTI...CW -30 mm height-

ECG-type	Sequence	PIN 6	PIN 5	PIN 4	PIN 3	PIN 2	PIN 1
QT-FH 1x14-35 CW	6-1	2	2			1	1
QT-FH 2x14.35 CW	6-1	2	2	2	2	1	1

ECG-type	Sequence	PIN 1	PIN 2	PIN 3	PIN 4
QT-FH 1x14	1-4	2	2	1	1
QT-FH 1x21	1-4	2	2	1	1

ECG-type	Sequence	PIN 1	PIN 2	PIN 3	PIN 4	PIN 5	PIN 6	PIN 7	PIN 8
QT-FH 3x14 CW	1-6 re	1,5	1,5	1,5	1,5	1	1	1	1
	3-8 li								

ECG-type	Sequence	PIN 1	PIN 2	PIN 3	PIN 4	PIN 5	PIN 6	PIN 7	PIN 8	PIN 9	PIN 10
QT-FH 4x14 CW	1-10 re	1,5	1,5	1,5	1,5	1,5	1,5	1	1	1	1
	3-8 li										

7.1.3 QT-FQ...CW -30 mm height-

ECG-type	Sequence	PIN 6	PIN 5	PIN 4	PIN 3	PIN 2	PIN 1
QT-FQ 1x24 CW	6-1	1	1			2	2
QT-FQ 1x39 CW	6-1	1	1			2	2
QT-FQ 1x49 CW	6-1	1	1			2	2
QT-FQ 1x54 CW	6-1	1	1			2	2
QT-FQ 1x80 CW	6-1	1	1			2	2
QT-FQ 2x24 CW	6-1	2	2	2	2	1	1
QT-FQ 2x39 CW	6-1	2	2	2	2	1	1
QT-FQ 2x49 CW	6-1	2	2	2	2	1	1
QT-FQ 2x54 CW	6-1	2	2	2	2	1	1

7.1.4 QT-FH MULTI...F/CW -21 mm height-

ECG-type	Sequence	PIN 1	PIN 2	PIN 3	PIN 4	PIN 5	PIN 6	PIN 7
QT-FH 1x14-35 F/CW	1-7	2	2				1	1
QT-FH 2x14-28 F/CW	1-7	1	1	2		2	2	2

**7.1.5 QT-FQ...F/CW
-21 mm height-**

ECG-type	Seque nce	PIN 1	PIN 2	PIN 3	PIN 4	PIN 5	PIN 6	PIN 7
QT-FQ 1x24-39 F/CW	1-7	2	2				1	1
QT-FQ 1x54 F/CW	1-7	2	2				1	1
QT-FQ 1x80 F/CW	1-7	2	2				1	1
QT-FQ 2x24-39 F/CW	1-7	1	1	2		2	2	2
QT-FQ 2x54 F/CW	1-7	1	1	2		2	2	2
QT-FQ 2x80	1-7	1	1	2		2	2	2

7.1.6 QT-FC

ECG-type	Seque nce	PIN 1	PIN 2	PIN 3	PIN 4	PIN 5	PIN 6	PIN 7
QT-FC 1x55/230-240 S	1-4	2	2	1	1			

7.2 Terminal Types

	WAGO 250	WAGO 251	WAGO 251- mini
QT-FH MULTI CW		X	
QT-FQ ... CW		X	
QT-FH 1x14, 21	X		
QT-FH 3, 4x14		X	
QT-FH...F/CW			X
QT-FQ...F/CW			X
QTi			X

Special features of particular terminals: see Section 3.1ff

7.3 Inrush Currents

QUICKTRONIC® INTELLIGENT	Ip[A]	T _H [μs]	Max. number of ECGs with automatic circuit breakers	
			10A	16A
QTi 1x14/24/21/39	1	155	26	41
QTi 1x28/54	1	155	26	41
QTi 1x35/49/80	1	155	26	41
QTi 2x14/24/21/39	1	200	19	31
QTi 2x28/54	1	200	19	31
QTi 2x35/49	1	200	19	31
QT-FQ 2x80	60	230	5	9

QUICKTRONIC® 21 mm height	Ip[A]	T _H [μs]	Max. number of ECGs with automatic circuit breakers	
			10A	16A
QT-FH 1x14-35 F/CW	17	155	25	41
QT-FH 2x14-28 F/CW	20	210	17	28
QT-FQ 1x24-39 F/CW	17	155	25	41
QT-FQ 1x54 F/CW	27	170	17	28
QT-FQ 1x80 F/CW	27	170	17	28
QT-FQ 2x24-39 F/CW	27	170	17	28
QT-FQ 2x54 F/CW	32	210	10	17
QT-FQ 2x80 F/CW	39	260	8	14

QUICKTRONIC® 30mm height	Ip[A]	T _H [μs]	Max. number of ECGs with automatic circuit breakers	
			10A	16A
QT-FH 1x14-35 CW	20	210	17	28
QT-FH 2x14-35 CW	20	210	17	28
QT-FQ 1x24 CW	17	155	25	41
QT-FQ 1x39 CW	17	155	25	41
QT-FQ 1x49 CW	20	210	17	28
QT-FQ 1x54 CW	20	210	17	28
QT-FQ 1x80 CW	28	230	8	13
QT-FQ 2x24 CW	20	210	17	28
QT-FQ 2x39 CW	28	230	8	13
QT-FQ 2x49 CW	28	230	8	13
QT-FQ 2x54 CW	28	230	8	13
QT-FH 1x14	17	155	25	41
QT-FH 1x21	17	155	25	41
QT-FH 3x14 CW	20	230	17	28
QT-FH 4x14 CW	20	230	17	28

QUICKTRONIC® for FC	Ip[A]	T _H [μs]	Max. number of ECGs with automatic circuit breakers	
			10A	16A
QT-FC 1x55/230-240 S	28	230	8	13

7.4 Lamp/ECG Combinations

Valid Lamp-ECG combinations are available in the Lighting Programme.

Edition January 2005 also available in **Section 9** or under www.osram.com/ecg

7.5 OSRAM Installation Tips for T5-Systems

Maximum lamp temperatures for T5/∅ 16 mm fluorescent lamps compared to T8/∅ 26 mm-fluorescent lamps

	Max. temp. at lamp caps	Lamp centre	Electrode area
	°C	°C	°C
T8/L36W	120	45...55	100...120
T8/L58W	140	50...65	110...130
T5/FH28W	120	40...60	160 (200...250*)
T5/FQ54W	120	50...70	160 (200...250*)

*) in FH-ECG- Luminaires the lamp could be incorrectly used e.g. FH35W with FQ80W

7.5.1 Recommended Minimum Distance between Lamp and Reflector

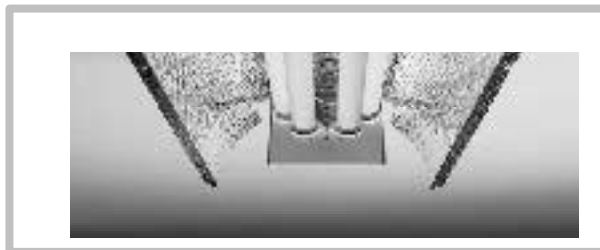

The maximum recommended base temperature of 120 °C may never be exceeded (see **Section 7.5**).

A distance of less than 3 mm between lamp and reflector can result in generation of noise even in luminaires with non-dimmable ECGs.

At a distance of less than 6 mm between lamp and reflector the leakage current of the dimmed lamps 35 W, 49 W and 80 W causes visible differences in brightness between the ends of the lamps. In addition, the radio interference suppression is getting worse.

OSRAM recommendation:

In general, OSRAM recommends to keep a **minimum distance of 6 mm** between lamp and reflector.

In certain cases (unfavourable capacitive interference) the minimum distance should be even greater.

7.5.2 Recommended Minimum Distance between two T5/Ø16mm-Fluorescent Lamps

OSRAM recommendation:

1. For high luminaire efficiency the distance should be at least 48 mm between the two lamps (approximately two fingers should fit between the lamps)
2. When designing the luminaire for minimum distance the maximum recommended base temperature of 120 °C may **never** be exceeded.



Exemptions:

Interference between dimmable ECG-lamp circuits in parallel configuration can cause flickering. Therefore, we recommend a minimum distance of 120 mm (from lamp axis to lamp axis) between two lamps in a dimmable two-lamp luminaire where two dimmable single-lamp ECGs are used. Or in other applications where multiple dimmable ECGs are used in parallel such as RGB-applications in illuminated ceilings.

If the wiring is done very carefully a minimum distance of 50 mm (between the two lamp axis) can be achieved.

7.5.3 Luminaire Optimisation

With the mentioned measuring principle the best correlation between ambient temperature and cold spot temperature of the T5-lamps is achieved.

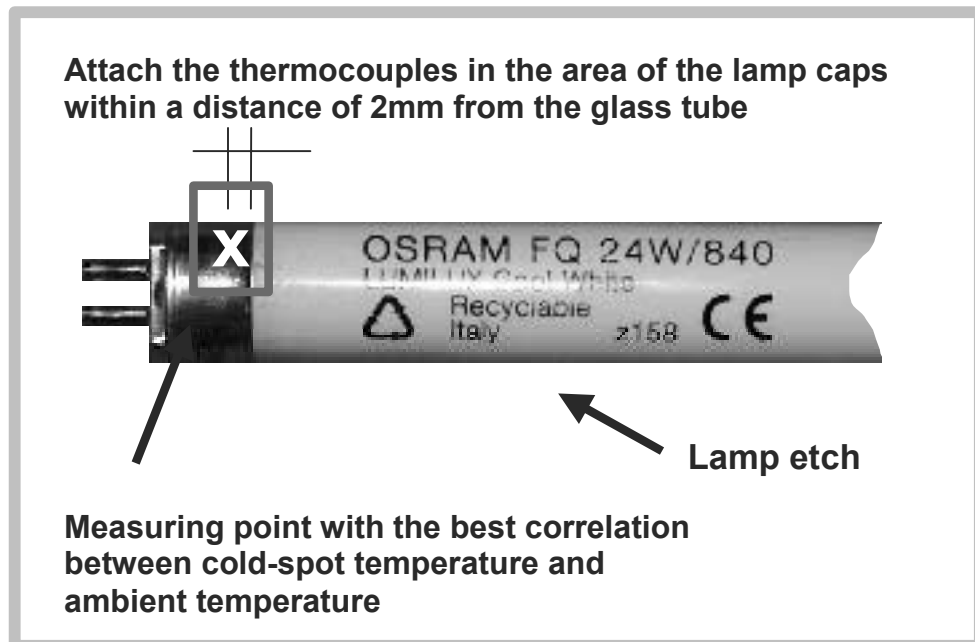

7.5.4 Maximum luminous flux for FH®...HE fluorescent lamps

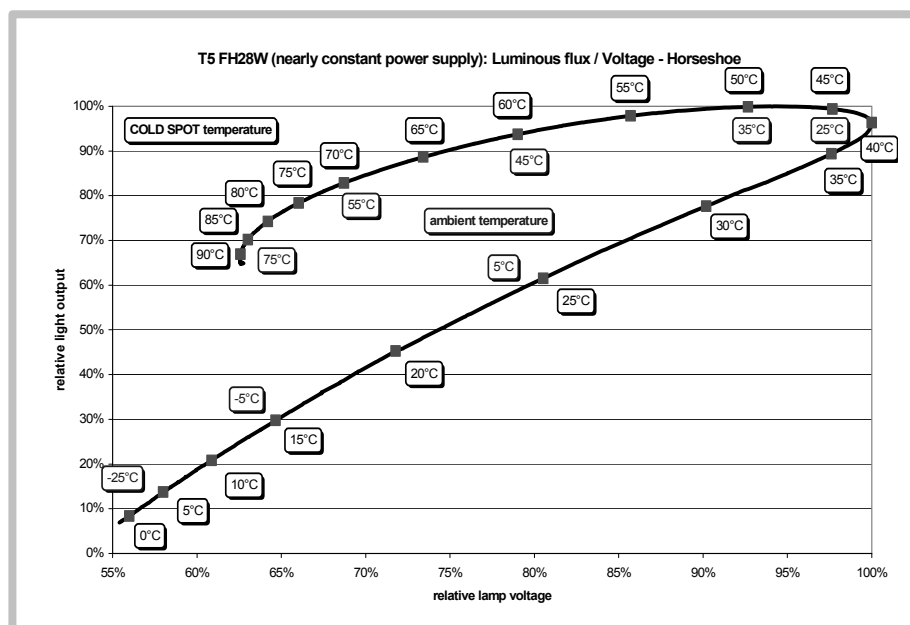

So called Horseshoe Curve shows the correlation in between the cold spot temperature and the ambient temperature t_a .

7.5.5 Verticalness Operation

If luminaires are operated in horizontal position the lamp stamp of the FH®...HE und FQ®...HO fluorescent lamps have to be placed down.

Luminaires with circular FC® lamps have to have the lamp socket positioned down.

8. Troubleshooting Tips

8.1 General

1) ECG in constant operation (24 hours)

Recommendation:

Installations with ECGs operating 24 hours a day should be switched off each day for a few minutes.

Reason

When a lamp comes to the end of its life there is an increase in lamp voltage causing an asymmetrical additional load in the ECG-circuit. When exceeding a certain value this additional load shuts down the ECG (EoL, T.2). When the ECG is switched on again all the relevant values of the lamps are checked and "critical" values can be detected.

2) Wiring of multiple ECG

Recommendation:

Lamp cables from different ECGs should not be routed together.

Reason:

Mutual interference may lead to problems with starting and/or normal operation (lamps may automatically disconnect)

3) Coding of the lamp cables

To speed up troubleshooting in luminaires and luminaire systems it is extremely useful for the lamp cables to be uniquely coded (colour coded or numbered). This applies especially to two-lamp ECGs and even more so to 3- and 4-lamp ECGs since the large number of cables increases the risk of connecting incorrectly.

4) Terminal blocks (2, 3, 4, 6 and 7 positions)

These terminal blocks are used with the majority of OSRAM ECGs. Note that only single core cables with a cross-section of 0.75 mm² to 1.5 mm² can be inserted without pressing the release tab. Larger cross-sections are not recommended; the release tab has to be pressed down for smaller cross-sections.

8.2 Equipment Behaviour on Overvoltage

Appearance of the lighting system:

The lamps are of different brightness (from time to time).

Depending on the ECG type, the internal shutdown circuit will operate at voltages above 280 V. In the event of a fault, the lamp generator will be disconnected. The mains input circuit and various other sub-circuits, however, continue to be supplied with this high voltage. If the mains voltage increases further there will be changes in the operating characteristics of the unit.

In most cases, this will lead to damage or destruction of the overvoltage-sensitive varistor/protective diode, which in turn will cause the unit fuse to trigger and damage to the unit.

If the system fault is corrected and the mains voltage has returned to the specified tolerance range without damage to the unit, the unit can continue to operate normally after an interruption in the mains supply and a recovery time of typically 20 seconds. If the mains voltage continues to be high, the unit will once again go into protection mode as soon as power flows to it. Over short periods of time, this state does not usually damage the unit.

If a QUICKTRONIC®-ECG for T5/Ø 16m m-fluorescent lamps is operated over long periods on a supply voltage greater than 280 V it may fail as a result of overheating (with the exception of QUICKTRONIC® INTELLIGENT).

8.3 Equipment Behaviour on Under Voltage

Important:

Significant under voltage can cause ECG failure for all ECG in constant wattage circuitry. Due to the characteristics of arrangement the line current increases for decreasing voltage. Below the specified voltage range this causes an overload of the filter chokes. First the colour of the copper wire and board below are changing. For a longer overload both windings of one or both filter chokes fail due to melting or swelling in the windings.

Compact and straight fluorescent lamps go out below the specified value of the ECG or even don't ignite if voltage is too low. The ECG will not be affected while the lamp is still burning. If the lamp is disabled at the end of its life (i.e. emitter paste is wasted), the safety shut-down of the ECG cannot work below the specified voltage range and a damage of the ECG is possible.

8.4 Application faults

8.4.1 Wiring faults on the lamp side

All single-lamp QUICKTRONIC® ECGs and units with 6-pole output terminals:

If there is a wiring fault the lamp will not operate or will cold start. In particularly serious cases there is a risk that the ECG will be destroyed.

8.4.2 Short-to-ground at the output of QUICKTRONIC® ECG

If there is a short-circuit-to earth at one or more of the connecting cables between the ECG and the lamp, the ECG will fail.

Damage to the ECG:

- Melting and swelling of only one winding on one or both input filter chokes
- Breakdown of one or two rectifier diodes, irrespective of whether they are discrete or integrated components.

There are, however, other causes of these major faults. Generally, as a consequence, consequential damage occurs at other components and this damage need not be unique in character.

8.4.3 Effects of moisture

Rust at the edges of metal housings may indicate the effects of moisture. If the printed circuit board and/or various components are tarnished, it can be assumed that there has been a serious moisture ingress. There will be short-circuits between neighbouring component connections or solder points with high potential difference, resulting in failure of the ECG. Symptoms of serious faults are indicated by a "tidemark" inside the housing.

8.4.4 Installing luminaires in draughty locations

Depending on the location of the fluorescent lamp in the draught, the lamp will cool down in certain areas of the bulb. This leads to local depletion of mercury and to a darkening of the lamp in these areas because there is no

mercury available to generate UV radiation.

This can be remedied by installing a thermal tube in the luminaire. The effect always or nearly always occurs in the area of the luminaire where the ECG is not located. This is due to the power loss of the ECG side of the luminaire will always be slightly warmer for the same reason.

Caution: Mercury depletion leads to a reduction in lamp voltage and to an increase in discharge current. This may result in damage to the ECG or, in extreme cases to failure of the ECG.

8.5 Trouble Shooting

8.5.1 Lamp does not start

Problem:

Lamp does not start (with two-lamp ECGs both lamps fail to start), no visible glow shortly after start-up. Same behaviour even after being off for 1 minute (internal reset) and restart.

Possible cause:

- a) RSD or other protective device in the installation has operated

Remedy:

Check the wiring on the mains side or insulation resistance. Has the max. recommended number of ECGs on one phase in a 3-phase system been exceeded= Make sure that the neutral conductor is connected properly to all the luminaires and makes good contact. Check that moisture has not penetrated the luminaire?

Possible cause:

- b) Fault in the wiring on the mains side

Remedy:

Check whether the mains voltage is in the required range for the ECG. Make sure that the neutral conductor is connected properly to all the luminaires and makes good contact. Check that the cables sit correctly in the terminals.

Possible cause:

- c) At least one lamp has reached the end of its life owing to a cathode break or increase in lamp voltage.

Remedy:

Replace the lamp (for two-lamp ECGs we recommend replacing both lamps at the same time to keep maintenance time and costs to a minimum).

Possible cause:

- d) The "fail-safe" overload protection device in the ECG has responded (the ECG is permanently damaged)

Remedy:

Check whether the lamp(s) operate at other positions. If not, check whether the mains voltage is within the permissible range. Make sure that the neutral conductor is connected properly to all the luminaires and makes good contact. Replace the ECG and lamp.

8.5.2 Brief Glimmer

Problem:

Lamp does not start but there is a brief glimmer from one or both lamp (i.e. the protective circuit in the ECG has responded at start-up). Same behaviour even after being off for one minute (internal reset) and restart

Possible cause:

- a) At least one lamp has reached the end of its life owing to a cathode break or increase in lamp voltage

Remedy:

Replace the lamp (for two-lamp ECGs we recommend replacing both lamps at the same time to keep maintenance time and costs to a minimum).

Possible cause:

- b) Wiring faulty between ECG and lamp (output terminals not used or reversed: contact problems in the holder or the terminals (e.g. wire cross-section too small or too large)

Remedy:

Check the lamp-side wiring for correct contact. Has the lamp connection been wired according to the wiring diagram on the ECG? For two-lamp ECGs in particular, check that the common or external connection is correctly wired.

Possible cause:

- c) A lamp with the wrong wattage has been installed or, in the case of two-lamp ECGs, only one lamp is installed or there are lamps of different wattages

Remedy:

The wattage and type of lamp must correspond to the wattage and type indicated on the ECG or the lamp/ECG combination should be in line with OSRAM's Indoor and Outdoor Lighting brochure. ECGs designed for two-lamp operation must be operated with two lamps.

Possible cause:

- d) The mains voltage lies outside the limit values indicated on the ECG or in the data sheet

Remedy:

Check the voltage at the ECG and at source; check the wiring on the mains side.

Possible cause:

- e) The temperature at the measuring point of the ECG is too high (for a brief description of the temperature at the ECG and lamp see end of text)

Remedy:

The luminaire or site of installation should be modified to ensure that the maximum recommended temperature is not exceeded even in onerous conditions (high ambient temperature and/or high supply voltage)

Possible cause:

- f) Changeover times and voltage levels are outside recommended tolerances for emergency lighting systems with changeover between AC and DC

Remedy:

Measure the DC supply voltage and check the switchover properties, or consult the equipment manufacturers.

Possible cause:

- g) Non-sinusoidal mains voltage or DC voltage with high residual ripple (e.g. operation with fully electronic leading edge phase control dimmer switch or artificial mains network/emergency generating set)

Remedy:

Check whether the mains voltage is in the required range for the ECG and the wave form or residual ripple in DC operation is within the specified limit values. Dimming is not recommended unless the ECG is expressly approved for dimming, in which case the prescribed controls (special accessories) must be used.

Possible cause:

- h) At least one lamp has reached the end of its life owing to an increase in lamp voltage

Remedy:

Replace the lamp (for two-lamp ECGs we recommend replacing both lamps at the same time to keep maintenance time and costs to a minimum)

8.5.3 Lamp goes out during operation

Problem:

The lamp goes out during operation (at least one lamp in the case of two-lamp units)

Possible cause:

- a) The reversible protection device in the ECG has responded during operation. The reason may be an intensive transient mains fault (mains voltage falls below the minimum voltage specified on the ECG for longer than permissible). Pulses of exceptional energy (transients) are superimposed on the mains voltage. The value of the mains voltage exceeds the maximum recommended value (e.g. because of a fault in the supply unit). Slow increase in mains voltage following neutral conductor break (unbalanced load, depending, among other things, on the mains load).

Remedy:

Disconnect the ECG or luminaire from the mains then check the supply voltage. If such problems occur sporadically, we recommend recording the mains voltage and/or using an oscilloscope or memory voltmeter. The electricity supplier may have to be consulted. Make sure that the neutral conductor is connected properly to this luminaire and makes good contact.

Possible cause:

- b) The temperatures at the measuring point on the ECG or at the cool spot on the lamp(s) are exceeded (for a brief description of the temperature at the ECG and lamp see end of text).

Remedy:

The luminaire or site of installation should be modified to ensure that the maximum recommended temperature is not exceeded even in onerous conditions circumstances (high ambient temperature and/or high supply voltage).

8.5.4 Different brightness levels

Problem:

Luminous output too low compared with other luminaires. Different brightness levels for the two lamps in two-lamp luminaires. Different brightness levels at the lamp ends

Possible cause:

- a) Typical maintenance behaviour of a fluorescent lamp at the end of its life

Remedy:

Replace the lamp (for two-lamp ECGs we recommend replacing both lamps at the same time to keep maintenance time and costs to a minimum).

Possible cause:

- b) Lamps of different wattages colour appearance or incorrect wattage

Remedy:

The lamp wattage must match the wattage indicated on the ECG. The colour appearance should be homogenous within an application.

Possible cause:

- c) Incorrect wiring between ECG and lamp (output terminals not used or reversed; contact problems)

Remedy:

Check the lamp-side wiring for correct contact. Has the lamp connection been wired according to the wiring diagram on the EG? For two-lamp ECGs in particular, check that the common or external connection is correctly wired. Pay particular attention in the case of special combinations.

Possible cause:

- d) Lamps are "force cooled" by draughts

Remedy:

Find the cause of the draught and either eliminate the draught or protect the lamps accordingly.

8.5.5 Fault in other electrical equipment

Problem:
Fault in other electrical equipment, particularly radio and television receivers

Possible cause:

- a) Wiring problems

Remedy

Lamp cables should be short, far enough away (> 5 cm) from earthed metallic parts and, if possible, not laid parallel to mains cables (particularly in the luminaire). If cross-overs are needed they must be at right angles. The mains cables must also be as short as possible.

Possible cause:

- b) Electrical equipment, radios and televisions are inadequately immunity to interference

Remedy:

Increase the distance between the luminaire and the equipment, if necessary, contact the manufacturer.

Possible cause:

- c) The IR remote control signals for TV operate at a similar frequency to the ECG

Remedy:

Move the IR receiver on the TV out of the radiation field of the lamp or disable it.

8.5.6 Problems at master-slave operation

Problem:
Problems on master-slave arrangements for 2lamp ECGs

Possible cause:

Wiring problems

Remedy:

Lamp cables should be short, far enough away (> 5 cm) from earthed metallic parts and, if possible, not laid parallel to mains cables (particularly in the luminaire). If cross-overs are needed they must be at right angles. The mains cables must also be as short as possible. In master-slave arrangements the maximum length of the cable to the daughter luminaire must not be exceeded.

8.5.7 Huming or “chirping” from the ECG

Problem:
Huming or “chirping” from the ECG

Possible cause:

Non-sinusoidal AC voltage

Remedy:

Eliminate sources of interference if necessary in consultation with the electricity supplier.

9. Lamp-ECG Combinations

9.1 FQ®...HO-Fluorescent Lamps

	Lamp	ECG type	LxWxH [mm]	P _{Sys} [W]	Im
1-lp	FQ® 24W	QTi 1x14/24/21/39	360 x 30 x 21	27	1750
		QT-FQ 1x24... CW	360 x 30 x 30	27	1750
		QT-FQ 1x24-39...F/CW	360 x 30 x 21	28	1750
		QT-M 1x26-42...S	103 x 67 x 31	27	1750
		QT 1x24/230-240	237 x 30 x 30	25	1750
		QT-ECO 1x18-24...S	80 x 40 x 22	22	1600
		QT-ECO 1x18-24...L	150 x 22 x 22	22	1600
2-lp	FQ® 24W	QTi 2x14/24/21/39	423 x 30 x 21	54	2x1750
		QT-FQ 2x25...CW	360 x 30 x 30	51	2x1750
		QT-FQ 2x54... F/CW	423 x 30 x 21	53	2x1750
		QT-M 2x26-32 ... S	123 x 79 x 33	54	2x1750

	Lamp	ECG type	LxWxH [mm]	P _{Sys} [W]	Im
1-lp	FQ® 39W	QTi 1x14/24/21/39	360 x 30 x 21	43	3100
		QT-FQ 1x39 ... CW	360 x 30 x 30	42	3100
		QT-FQ 1x24-39...F/CW	360 x 30 x 21	41	3100
		QT-M 1x26-42 ... S	103 x 67 x 31	40	3000
2-lp	FQ® 39W	QTi 2x14/24/21/39	423 x 30 x 21	88	2x3100
		QT-FQ 2x39...CW	360 x 30 x 30	85	2x3100
		QT-FQ 2x24-39...F/CW	423 x 30 x 21	82	2x3100

	Lamp	ECG type	LxWxH [mm]	P _{Sys} [W]	Im
1-lp	FQ® 49W	QTi 1x35/49/80	360 x 30 x 21	55	4300
		QT-FQ 1x49...CW	360 x 30 x 30	54	4300
2-lp	FQ® 49W	QTi 2x35/49	423 x 30 x 21	110	2x4300
		QT-FQ 2x49...CW	360 x 30 x 30	110	2x4300

	Lamp	ECG type	LxWxH [mm]	P _{Sys} [W]	Im
1-lp	FQ® 54W	QTi 1x28/54	360 x 30 x 21	61	4450
		QT-FQ 1x54...CW	360 x 30 x 30	61	4450
		QT-FQ 1x54...F/CW	360 x 30 x 21	59	4450
2-lp	FQ® 54W	QTi 2x28/54	423 x 30 x 21	119	2x4450
		QT-FQ 2x54...CW	360 x 30 x 30	118	2x4450
		QT-FQ 2x54...F/CW	423 x 30 x 21	122	2x4450

	Lamp	ECG type	LxWxH [mm]	P _{Sys} [W]	Im
1-lp	FQ® 80W	QTi 1x35/49/80	360 x 30 x 21	89	6150
		QT-FQ 1x80...CW	360 x 30 x 30	86	6150
		QT-FQ 1x80...F/CW	360 x 30 x 21	87	6150
2-lp	FQ® 80W	QT-FQ 2x80	423 x 30 x 21	176	2x6150

9.2 FH[®]...HE-Fluorescent Lamps

	Lamp	ECG type	LxWxH [mm]	P _{Sys} [W]	Im
1-lp	FH[®] 14W	QTi 1x14/24/21/39	360 x 30 x 21	18	1200
		QT-FH 1x14-35...CW	360 x 30 x 30	18	1200
		QT-FH 1x14-35...F/CW	360 x 30 x 21	18	1200
		QT-FH 1x14	237 x 30 x 30	16	1200
		QT-ECO 1x4-16...S	80 x 44 x 22	15	1200
		QT-ECO 1x4-16...L	150 x 22 x 22	15	1200
2-lp	FH[®] 14W	QTi 2x14/24/21/39	423 x 30 x 21	32	2x1200
		QT-FQ 2x14-35...CW	360 x 30 x 30	31	2x1200
		QT-FH 2x14-28...F/CW	423 x 30 x 21	32	2x1200
3-lp	FH[®] 14W	QT-FH 3x14...CW	425 x 40 x 30	50	3x1200
4-lp	FH[®] 14W	QT-FH 4x14...CW	425 x 40 x 30	65	4x1200

	Lamp	ECG type	LxWxH [mm]	P _{Sys} [W]	Im
1-lp	FH[®] 21W	QTi 1x14/24/21/39	360 x 30 x 21	25	1900
		QT-FH 1x14-35...CW	360 x 30 x 30	24	1900
		QT-FH 1x14-35...F/CW	360 x 30 x 21	23	1900
		QT-FH 1x21	237 x 30 30	23	1900
		QT-ECO 1x18-21...S	80 x 40 x 22	23	1800
2-lp	FH[®] 21W	QTi 2x14/24/21/39	423 x 30 x 21	47	2x1900
		QT-FH 2x14-35...CW	360 x 30 x 30	46	2x1900
		QT-FH 2x14-28...F/CW	423 x 30 x 21	46	2x1900

	Lamp	ECG type	LxWxH [mm]	P _{Sys} [W]	Im
1-lp	FH[®] 28W	QTi 1x28/54	360 x 30 x 21	32	2600
		QT-FH 1x14-35...CW	360 x 30 x 30	31	2600
		QT-FH 1x14-35...F/CW	360 x 30 x 21	31	2600
2-lp	FH[®] 28W	QTi 2x28/54	423 x 30 x 21	63	2x2600
		QT-FH 2x14-35...CW	360 x 30 x 30	61	2x2600
		QT-FH 2x14-28...F/CW	423 x 30 x 21	61	2x2600

	Lampe	ECG type	LxBxH [mm]	P _{Sys} [W]	Im
1-lp	FH[®] 35W	QTi 1x35/49/80	360 x 30 x 21	39	3300
		QT-FH 1x14-35...CW	360 x 30 x 30	38	3300
		QT-FH 1x14-35...F/CW	360 x 30 x 21	38	3300
2-lp	FH[®] 35W	QTi 2x35/49	423 x 30 x 21	79	2x3300
		QT-FH 2x14-35...CW	360 x 30 x 30	77	2x3300

9.3 FC[®]...Fluorescent Lamps

	Lamp	ECG type	LxBxH [mm]	P _{Sys} [W]	Im
1-lp	FC[®] 22W	QT-FQ 1x24...CW	360 x 30 x 30	27	1800
		QT-M 1x26-42...S	103 x 67 x 31	26	1800
		QT-ECO 1x18-24...S	80 x 40 x 22	22,5	1650
		QT-ECO 1x18-24...L	150 x 22 x 22	22,5	1650
2-lp	FC[®] 22W	QT-FQ 2x24...CW	360 x 30 x 30	51	2x1800
		QT-M 2x26-32...S	123 x 79 x 33	54	2x1800
		QT 2x24...	280 x 42 x 30	51	2x1800

	Lamp	ECG type	LxBxH [mm]	P _{Sys} [W]	Im
1-lp	FC [®] 40W	QT-FQ 1x39...CW	360 x 30 x 30	42	3200
		QT-M 1x26-42...S	103 x 67 x 31	44	3200
2-lp	FC [®] 40W	QT-FQ 2x39...CW	360 x 30 x 30	85	2x3200

	Lamp	ECG type	LxBxH [mm]	P _{Sys} [W]	Im
1-lp	FC [®] 55W	QT-FQ 1x55...S	123 x 79 x 33	60	4000

	Lamp	ECG type	LxBxH [mm]	P _{Sys} [W]	Im
	FC [®] 22 + 40	QT-M 2x26-32...S	123 x 79 x 33	70	1800 + 3200

10. Tender Documents

See www.osram.com/ecg/tender-documents

10.1 QUICKTRONIC® INTELLIGENT QT*i*

µProcessor controlled ECG to operate T5/∅ 16 mm fluorescent lamps
FQ®...HO and FH®...HE in equal length.

Automatic lamp detection during lamp starting

Optimized Operation of all approved lamps with rated data

Lamp operation acc. to EN 60929 and IEC 60929

Range :

QT*i* 1x35/49/80

QT*i* 1x28/54

Geometry: 360 x 30 x 21 mm³

QT*i* 1x14/24/21/39

QT*i* 2x35/49

QT*i* 2x28/54

Geometry: 423 x 30 x 21 mm³

QT*i* 2x14/24/21/39

Lamp Preheat Start within 1 Second

Ambient Temperature: -20 °C up to +50 °C

Emergency Lighting acc. to . DIN VDE 0108 (EN 61347-2-3) possible

DC Voltage Range: 154 V to 276 V

AC Voltage Range:: 198 V to 254 V

Approval Marks:



Automatic restart after lamp replacement

ECG-lifetime: 50.000 h with a max. 10 % failure rate (at tc = 70 °C)

10.2 QUICKTRONIC® MULTIWATT for FH...HE h = 30 mm

Fully electrical, digital control gear to operate all FH®...HE-fluorescent
lamps

Lamp preheat start within 1 Second

Combi Wiring Terminal for automatic and manual wiring



Ambient Temperature: -20 °C to +50 °C

Emergency lighting acc. to DIN VDE 0108 (EN 61347-2-3) possible

DC Voltage Range: 154 V to 276 V

AC Voltage Range: 198 V to 254 V



Range:

QUICKTRONIC® MULTIWATT

QT-FH 1x14-35/230-240 CW
QT-FH 2x14-35/230-240 CW
Geometry: 360 x 30 x 30 mm³

Automatic restart after lamp replacement
ECG-lifetime: 50.000 h with a max. 10 % failure rate (at tc = 70 °C)

**10.3 QUICKTRONIC® for
FQ...HO
h = 30 mm**

Fully electronical, digital control gear to operate all FQ®...HO fluorescent lamps
Lamp preheat start within 1 Second
Combi Wiring Terminal for automatic and manual wiring

 - Circuitry

Ambient Temperature: -20 °C to +50 °C

Emergency Lighting acc. to DIN VDE 0108 (EN 61347-2-3) possible

DC Voltage Range: 154 V to 276 V

AC Voltage Range: 198 V to 254 V

 -Circuitry

Range:

QUICKTRONIC® for FQ®...HO fluorescent lamps

QT-FQ 1x24/230-240 CW QT-FQ 2x24/230-240 CW

QT-FQ 1x39/230-240 CW QT-FQ 2x39/230-240 CW

QT-FQ 1x49/230-240 CW QT-FQ 2x49/230-240 CW

QT-FQ 1x54/230-240 CW QT-FQ 2x54/230-240 CW

QT-FQ 1x80/230-240 CW

Geometry: 360 x 30 x 30 mm³

Automatic restart after lamp replacement
ECG-lifetime: 50.000 h with a max. 10 % failure rate (at tc = 70 °C)

11. Index

Technical data are subject to change without any notes.
Printed data in this edition replace previous.

Ambient Temperature	3.9.2
Approval Marks	2.17
Automatic Relamping	2.5
Cable Cross Section	3.1.2
Cable Length	3.3; 7.1
Cable Routing	3.1.6
Cable Type	3.1.1
CCC-Mark	2.20
CE-Mark	2.17.2; 2.19
Circuit breaker	3.15
Cold Spot	3.9.3; 3.9.5; 7.5.4
Conducted Interferences cut-off Technology	3.2.2.2 2.14
DC-Voltage	6.6
ECG in Sound Studios	6.5
ECG Milestones	1.12
ECG Temperature	3.9.2
Economy	2.2
EEL	2.18
Electromagnetic Compatibility EMC	2.19; 3.2
Electromagnetic Disturbances	6.3.1
Emergency Lighting	6.5
End-of-Life	2.17.1
Energy Saving	1.6
Exterior Applications	6.1
Failure Rate	2.10
FAQ for QTi	5.7
Fault Currents	3.16; 6.1.1
Fluorescent Circline	1.2.3
Functional Earth	3.7 ff
Harmonic Content	3.2 ff
High Efficiency FH® ...HE	1.2.1
High Output FQ® ...HO	1.2.2
High Voltage Test	3.13
Hot Wires	3.4
Humidity	3.3; 3.9; 6.1.1
Ignition Time	6.5.1 ff
Immunity	3.2 ; 8.5.5
Inrush Current	3.14
Installation Instructions	3.2.2.5; 3.9.4; 6.1.1
Insulation Distances	3.12
Insulation Test	3.13
Insulation	3.1.4

Lamp Failure	2.6
Lamp Temperature	3.9.3
Lamp-ECG-Combination	7.4 ; 9 ff
Leakage Current	3.16
Lifetime	2.12; 3.9.1
Lighting Comfort	2.1
Line Voltage 120 V/277 V	2.4.7
Line Voltage	2.4 ff
Luminaire Wiring Test	3.10
Magnetic Field	3.2.2.4
Master-Slave-Operation	8.5.6
Measurementpoint Temperature	3.9.2.1
Noise	2.7; 6.2.1
OUTKIT	6.1; 6.1.2
Overvoltage	2.3; 2.4; 1 f; 8.2
PE Connection	3.7
PE-Connection	3.7; 3.8.2; 3.11
Permissible Cable Lengths	3.3; 7.1 ff
Power Factor λ	2.8
Protection Class I or II	3.11; 6.7
QUICKTRONIC® INTELLIGENT QT <i>i</i>	5 ff
Radio Interference Suppression	2.17; 3.2.2; 3.1.6; 3.4
Reliability	2.10
Resistance to Frequent Switching	2.11
Safety Lighting	6.5
Safety	2.3
Selective Shielding	3.2.2.4
Self heating	3.9.1
Storage Temperature	3.9
Switching between Lamp and ECG	3.5
ta Ambient Temperature	3.9 ff
tc Measurement Point	3.9.2.1
Temperature Measurement	3.9.5
Temperature Range	3.9
Tender Documents	10f
Terminals	7.2
Test Adapter	3.10.1
Thermal Influences	2.13
Three-Phase-System	3.13.3
Treatment Rooms	6.3
Troubleshooting Tips	8ff
Undervoltage	2.4.3 f; 8.3
U-OUT	2.16

VDE-EMC sign	2.8; 2.17.2
VDE-sign	2.19
Voltage Range	2.4
Voltage Resistance	3.13.4 ; 3.17
Wiring Diagrams	3.1 ff; 6.1.1

Head office Germany

OSRAM GmbH
Hellabrunner Straße 1
81543 München
Tel.: +49-89-62 13-0
Fax: +49-89-62 13-20 20

International addresses

Albania

(supported by OSRAM Greece)

Argentina

OSRAM Argentina S.A.C.I.
Ramos Mejia 2456
B 1643 ADN Beccar
Pcia. De Buenos Aires
Tel.: +54-11-6333-8000
Fax: +54-11-6333-8001

Australia

OSRAM Australia Pty. Ltd. Sydney
11th Floor, Building 1
423 Pennant Hills Road
2120 Pennant Hills, N.S.W.
P.O. Box 673
1715 Pennant Hills
Tel.: +61-29-4 81-83 99
Fax: +61-29-4 81-91 27

Austria

OSRAM GmbH
Lemböckgasse 49/C/5
1230 Wien
Postfach 1 62
1231 Wien
Tel.: +43-1-6 80 68-0
Fax: +43-1-6 80 68-7

Azores

(supported by OSRAM Portugal)

Benelux

OSRAM Benelux B.V.
Klaverbaan 102
2908 KD Capelle a/d IJssel
Netherlands
Tel.: NL +31-10-750 14 14
BE +32-78-55 08 20
Fax: NL +31-10-750 14 06
BE +32-78-55 08 28

Bosnia-Herzegovina

(supported by OSRAM Croatia)

Brazil

OSRAM do Brasil Lâmpadas Elétricas Ltda.
Av. Dos Autonomistas, 4229
06090-901 Osasco-SP/Brazil
Tel.: +55-11-36 84 74 08
Fax: +55-11-36 85 94 95

Bulgaria

OSRAM EOOD
Nikola Obreschkov 1
Wh. A., App. 1
1113 Sofia
Tel.: +359-2-9 71 22 62
Fax: +359-2-9 71 45 46

Canada

OSRAM SYLVANIA Ltd./Lte.
2001 Drew Road
Mississauga
Ontario L5S 1S4
Tel.: +1-905-6 73 61 71
Fax: +1-905-6 71 55 84

Chile

OSRAM Chile Ltda.
Santa Elena de Huechuraba
1135 B
Comunada Huechuraba
Santiago de Chile
Tel.: +56-2-7 40-09 39
Fax: +56-2-7 40-04 66

China

OSRAM China Lighting Ltd.
No.1 North Industrial Road,
Postal Code 528000
Foshan, Guangdong
Tel.: +86-757-864 82-111
Fax: +86-757-864 82-222

OSRAM Shanghai Rep. Office
Harbour Ring Plaza
No. 18 Xi Zang Middle Road
Room 2802, 2803 A
Shanghai, 200001 P.R.C.
Tel.: +86-21-53 85 28 (48)
Fax: +86-21-64 82 12 19

Colombia

OSRAM de Colombia
Diagonal 109 No. 21-05
Oficina 607, 608
Bogotá
Tel.: +57-1-6 19 24 07
Fax: +57-1-6 37 18 55

Croatia

OSRAM d.o.o.
Majstora Radonje 10
10000 Zagreb
Tel.: +385-1-303-20 00
Fax: +385-1-303-20 01

Czechia

OSRAM spol. s.r.o.
Kodanska 1441/46
100 10 Praha 10
Tel.: +420-234 06 60 00
Fax: +420-234 06 60 20

Denmark

OSRAM A/S
Dybendalsvænget 3
2630 Tåstrup
Postboks 259
2630 Tåstrup
Tel.: +45-44-77 50-00
Fax: +45-44-77 50-55

Egypt

OSRAM Rep. Office Cairo
5th Floor, Unit No. 507
57 Giza Street
Cairo, Giza
Tel.: +20-2-7 48 66 46
Fax: +20-2-7 48 66 46

Ecuador

OSRAM del Ecuador S.A.
Casilla 09-01-8410
Guayaquil
Tel.: +593-4-2 89 36 09
Fax: +593-4-2 89 35 58

Estonia

(supported by OSRAM Finland)

Finland

Oy OSRAM AB, Helsinki
Vanha Porvoontie 229
01380 Vantaa
Box 91
01301 Vantaa
Tel.: +358-9-74 22 33 00
Fax: +358-9-74 22 33 74

France

OSRAM SASU
5, Rue d'Altorf
67124 Molsheim
BP 1 09
67124 Molsheim
Tel.: +33-388-49 75 99
Fax: +33-388-49 75 975

Great Britain

OSRAM Ltd., London
OSRAM House
Waterside Drive
Langley, Berkshire
SL3 6EZ
Tel.: +44-17 53 48 4 (100)
Fax: +44-17 53 48 42 22

Greece

OSRAM A.E.
Frantzi 6 & Ag. Pavliou
12132 Peristeri
Tel.: +30-210-5 20 18 00
Fax: +30-210-5 22 72 00

Hong Kong

OSRAM Prosperity Co. Ltd.
Rm 4007-09 Office Tower
Convention Plaza
1 Harbour Road, Wanchai
Tel.: +852-25 11 22 68
Fax: +852-25 11 20 38

Hungary

OSRAM KFT.
Alkotás utca 41.
1123 Budapest
Tel.: +36-1-2 25-30 55
Fax: +36-1-2 25-30 54

India

OSRAM India Private Ltd.
Signature Towers, 11th Floor,
Tower-B South City-I
122001 Gurgaon Haryana/India
Tel.: +91-124-238 31-80
Fax: +91-124-238 31-82

Indonesia

PT. OSRAM Indonesia
Jalan Siliwangi KM 1
Desa Keroncong
Jatiuwung
15134 Tangerang
Tel.: +62-21-5 90 01 27
Fax: +62-21-5 90 05 59

Iran

OSRAM Lamps
OSRAM PJS Co.
Bokharest Ave, Str. 6, No. 13
Tehran
Tel.: +98-21-8 73 84 76
Fax: +98-21-8 73 24 13

Italy

OSRAM Società Riunite
OSRAM Edison-Clerici Spa
Via Savona 105
20144 Milano
Tel.: +39-02-42 49-1
Fax: +39-02-42 49-380

Japan

OSRAM MELCO Ltd.
Tobu Yokohama Bldg.No. 3 (4F)
8-29 Kita-Saiwai 2-chome, Nishi-Ku
220-0004 Yokohama
Tel.: +81-45-3 23 51-29-0
Fax: +81-45-3 23 51-55

OSRAM Ltd.

Tobu Yokohama Bldg.No. 3 (6F)
8-29 Kita-Saiwai 2-chome, Nishi-Ku
220-0004 Yokohama
Tel.: +81-45-3 23 51-00
Fax: +81-45-3 23 51-10

Korea

OSRAM Korea Co. Ltd.
3rd. Fl. Ye-Sung Bldg.
150-30 Samsung-dong, Kangnam-Ku
Seoul 135-090
Tel.: +82-2-5 54 41 12
Fax: +82-2-5 56 16 44

Latvia

(supported by OSRAM Finland)

Lithuania

(supported by OSRAM Finland)

Macedonia

(supported by OSRAM Greece)

Madeira

(supported by OSRAM Portugal)

Malaysia

OSRAM Sdn Bhd
7,05-7,06 Amoda Building
22 Jalan Imbi
55100 Kuala Lumpur
Tel.: +60-3-21 45 95-33
Fax: +60-3-21 45 95-35

Mexico

OSRAM de México, S.A. de C.V.
Camino a Tepalcapa No. 8
Col. San Martín
54900 Tultitlán
Edo. de México
Tel.: +52-55-58 99-18 00
Fax: +52-55-58 84-70 00

Norway

OSRAM AS
Strandveien 50
1366 Lysaker
Tel.: +47-67 83 67-00
Fax: +47-67 83 67-40

Philippines

OSRAM Philippines Ltd. Corp.
Unit 2002-2003
Antel Global Corporate Center
Julia Vargas Avenue
Ortigas Center
Pasig City
Tel.: +632-687 60 48-50
Fax: +632-687 60 57

Poland

OSRAM sp. z o.o.
ul. Wiertnicza 117
02-952 Warszawa
Tel.: +48-22-550 23 00
Fax: +48-22-550 23 19

Portugal

OSRAM Empresa de
Aparelhagem Eléctrica Lda.
Rua do Alto do Montijo
Nr. 15-4 andar
2794-069 Carnaxide
Tel.: +351-2 14 16 58 60
Fax: +351-2 14 17 12 59

Romania

OSRAM Romania S.R.L.
Calea Plevnei nr. 139
corp B, sector 6
060011 Bucaresti
Tel.: +40-21-2077-386
Fax: +40-21-2077-389

Russia

OSRAM Moscow
Ul. Malaja Kaluschskaja 15/4
119071 Moscow
Tel.: +7-095-9 35 70-70
Fax: +7-095-9 35 70-76

Serbia and Montenegro

OSRAM d.o.o., Beograd
Cika Ljubina 15/V
YU-11000 Beograd
Tel.: +381 (0)11-30 30-860
Fax: +381 (0)11-30 30-853

Singapore

OSRAM Pte. Ltd.
159 Sin Ming Road
#05-04 Amtech Building
575625 Singapore
Tel.: +65-65 52 01 10
Fax: +65-65 52 71 17

Slovakia

OSRAM Nové Zámky
Komárnanská cesta 7
94093 Nové Zámky
Tel.: +42-1-35 64 64-0
Fax: +42-1-35 64 64-880

Slovenia

(supported by OSRAM Austria)

South Africa

OSRAM (Pty.) Ltd.,
260, 15th Road
1683 Randjespark/Midrand
Private BAG X 206
1685 Halfway House/Midrand
Tel.: +27-11-2 07 56 00
Fax: +27-11-8 05 17 11

Spain

OSRAM, S.A.
Calle de la Solana, 47
28850 Torrejón de Ardoz (Madrid)
Tel.: +34-91-6 55 52 00
Fax: +34-91-6 56 82 16

Sweden

OSRAM AB
Rudanvägen 1
13625 Haninge
Box 5 04
13650 Haninge
Tel.: +46-8-7 07 44-00
Fax: +46-8-7 07 44-40

Switzerland

OSRAM AG, Winterthur
In der Au 6
8401 Winterthur/Töss
Postfach 2179
8401 Winterthur/Töss
Tel.: +41-52-2 09 91 91
Fax: +41-52-2 09 92 75

Taiwan

OSRAM Taiwan Company Ltd.
Sung Chiang Road, 7th Floor, No. 87
Sung Chiang Road
P.O. Box 46304
Taipei - Taiwan, R.O.C.
Tel.: +886-2-25 08 35 02
Fax: +886-2-25 09 67 82

Thailand

OSRAM Thailand Co. Ltd.
100/45, 24th Floor
Sathorn Nakorn Tower
North Sathorn Road
Khwaeng Silom
Khet Bangrak, Bangkok 10500
Tel.: +66-2-6 36 74 75
Fax: +66-2-6 36 74 77

Turkey

OSRAM AMPUL TIC. A.S.
Meclisi Mebusan Caddesi 125
04000 Fındıklı, Istanbul/TR
Tel.: +90-212-334-1334
Fax: +90-212-334-1142

Ukraine

OSRAM Ukraine
Podil Plasa Business Center
30-A Spaska Str., office 2-3B
Kiev 04070
Tel.: +38-044-467 66 67
Fax: +38-044-467 69 58

United Arab Emirates

OSRAM Middle East FZE
P.O. Box 17476
Room #602-603, LOB #16
Jebel Ali Free Zone
Dubai United Arab Emirates
Tel.: +971-4-88 13-767
Fax: +971-4-88 13-769

USA

OSRAM SYLVANIA INC.
100 Endicott Street
Danvers, MA 01923
Tel.: +1-978-777-19 00
Fax: +1-978-750-21 52

Vietnam

OSRAM Singapore Pte. Ltd.
Rep. Office Vietnam
59A Ly Thai To Street,
Hanoi Press Club
Hoan Kiem District
Hanoi
Tel.: +84-4-93 49-801
Fax: +84-4-93 49-803

Internet

<http://www.osram.de>
<http://www.osram.com>
<http://catalog.myosram.com/DE>
<http://catalog.myosram.com/EN>