



SZ

2388.150



4028177318243

10x



Ø4-15

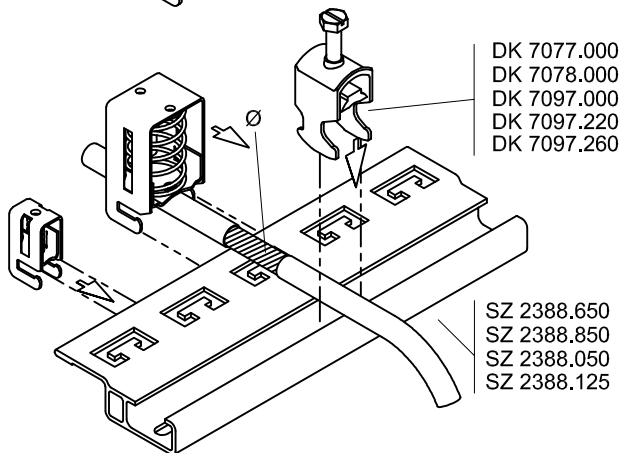

Zchnng.-Nr. / No. of dwg. : A06927801SZ
Versandbeutel-Nr. / No. of accessory bag : -

Lieferanten-Nr. / No. of supplier :