

Rittal – The System.

Faster – better – everywhere.

**Anreihverbinder, außen VX IT,
für Anreihspalt 3 mm
Baying connector, external VX IT,
for 3 mm baying gap
Attaches de juxtaposition extérieures
VX IT, pour espace de juxtaposition
de 3 mm**

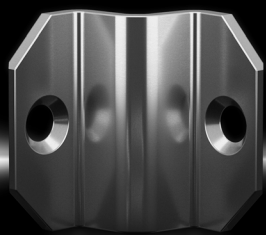

5301.310

**Montageanleitung
Assembly instructions
Notice de montage**

ENCLOSURES

POWER DISTRIBUTION

CLIMATE CONTROL

IT INFRASTRUCTURE

SOFTWARE & SERVICES



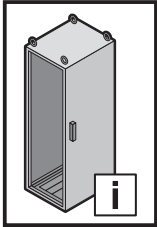

Inhaltsverzeichnis
Contents
Sommaire

DE

1. Hinweise zur Dokumentation	4
1.1 Aufbewahrung der Unterlagen	4
1.2 Verwendete Symbole	4
1.3 Bestimmungsgemäße Verwendung	4
2. Zusätzliches Zubehör	4
3. Sicherheitshinweise	5–8
4. Montage Anreihverbinder, außen VX IT	9–10

EN

1. Notes on documentation	4
1.1 Retention of documents	4
1.2 Symbols used	4
1.3 Intended use	4
2. Additional accessories	4
3. Safety instructions	5–8
4. Mounting the baying connector, external VX IT	9–10

FR

1. Remarques relatives à la documentation	4
1.1 Conservation des documents	4
1.2 Symboles utilisés	4
1.3 Utilisation correcte	4
2. Accessoires complémentaires	4
3. Consignes de sécurité	5–8
4. Montage des attaches de juxtaposition extérieures VX IT	9–10

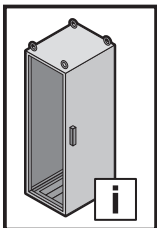

Inhaltsverzeichnis
Contents
Sommaire

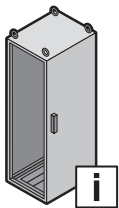

2–8

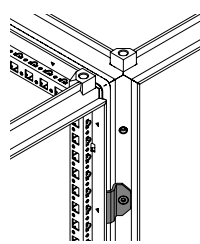

9–10

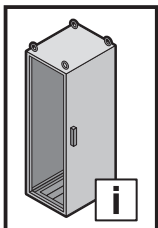

Lieferumfang
Scope of delivery
Composition de la livraison

Best.-Nr. VX/Model No. VX/Référence VX Stahlblech/Sheet steel/Tôle d'acier	5301.310	
		4 x
	8 m	1 x
	M6 x 14	8 x



Die maximal zu erreichende Schutzart beträgt IP 20.



The maximum achievable protection category is IP 20.



L'indice de protection maximal à atteindre est IP 20.



Ein Transport von angereihten Schränken ist nicht zulässig.



The transportation of bayed enclosure suites is not allowed.



Le transport d'armoires juxtaposées n'est pas toléré.

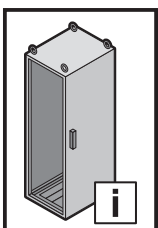

Abkürzungsverzeichnis
Table of abbreviations
Répertoire des abréviations

DE

–M_A: Anzugsdrehmoment

EN

–M_A: Tightening torque

FR

–M_A: Couple de serrage

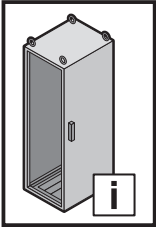

1. Hinweise zur Dokumentation

1. Notes on documentation

1. Remarques relatives à la documentation

DE

Die **Montageanleitung** richtet sich an Personen, die Einrichtungen der Informations- und Telekommunikationstechnik unter Kenntnis der länderspezifischen Sicherheitsvorschriften am Bestimmungsort aufstellen, anschließen und betreiben.

1.1 Aufbewahrung der Unterlagen

Die Dokumentation ist Teil des Produktes. Sie muss dem Anlagenbetreiber ausgehändigt werden. Dieser übernimmt die Aufbewahrung, damit die Unterlagen im Bedarfsfall zur Verfügung stehen.

1.2 Verwendete Symbole

Beachten Sie folgende Sicherheits- und sonstige Hinweise in der Anleitung:

Sicherheits- und andere Hinweise:



Gefahr!
Unmittelbare Gefahr für Leib und Leben.



Achtung!
Mögliche Gefahr für Produkt und Umwelt.



Hinweis:
Nützliche Informationen und Besonderheiten.



Hinweis:
Front-/Rückansicht.

EN

These **assembly instructions** have been written for personnel tasked with assembling, connecting and operating IT and telecommunications equipment at the intended location and who are familiar with the country-specific safety regulations.

1.1 Storing the documents

The safety notes and the accompanying note are part of the product. They must be given to the plant operator, who is then responsible for the storage of the documents so that they are readily available when needed.

1.2 Symbols used

Please observe the following safety instructions and other notes in this guide:

Safety and other notes:



Danger!
Immediate danger to life and limb.



Caution!
Potential threat to the product and its environment.



Note:
Useful information and special features.



Note:
Front/rear view.

FR

La **notice de montage** s'adresse aux personnes qui installent, raccordent et exploitent les installations IT et de télécommunication, dans le respect des prescriptions de sécurité spécifiques au pays où elles sont installées.

1.1 Conservation des documents

Les consignes de sécurité et la notice jointe font partie du produit. Elles doivent être remises à l'exploitant de l'installation. Celui-ci les conservera de manière à ce qu'elles soient disponibles en cas de besoin.

1.2 Symboles utilisés

Tenir compte des consignes de sécurité et autres directives contenues dans cette notice :

Consignes de sécurité et autres directives :



Danger !
Risque de blessure grave, voire mortelle.



Attention !
Danger éventuel pour le produit et l'environnement.



Remarque :
Informations utiles et particularités.



Remarque :
F = vue frontale
R = vue arrière

1.3 Bestimmungsgemäße Verwendung

Anreihverbinder zum Anreihen von VX IT Racks am Aufstellungsort, mit einem Anreihspalt von 3 mm, für den Einsatz von einteiligen Trennwänden aus dem Rittal Zubehörprogramm bzw. den leichteren Austausch von einzelnen Racks innerhalb einer kompletten Rackreihe.

1.3 Intended use

Baying connector for baying VX IT racks at the installation site with a baying gap of 3 mm, for the use of one-piece divider panels from the Rittal range of accessories or for easier replacement of individual racks within a complete rack suite.

1.3 Utilisation correcte

Attaches de juxtaposition pour la juxtaposition de baies VX IT sur le lieu d'implantation, avec un espace de juxtaposition de 3 mm, pour la mise en œuvre de cloisons monobloc qui figurent dans la gamme d'accessoires Rittal ou pour le remplacement aisé de baies unitaires au sein d'une rangée complète de baies.

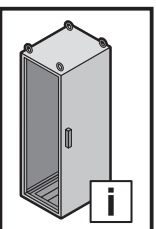

2. Zusätzliches Zubehör

2. Additional accessories

2. Accessoires complémentaires

Schottwand einteilig einschiebar, VX IT
Partition, one-piece, slide-in VX IT
Cloison de séparation monobloc à insérer VX IT

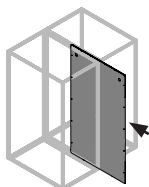

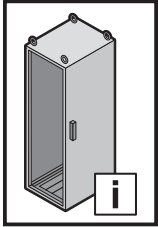





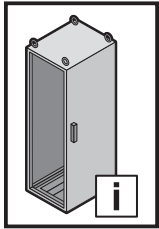





3. Sicherheitshinweise **3. Veiligheidsvoorschriften** **3. Advertencias de seguridad**
3. Safety instructions **3. Säkerhetsinstruktioner**
3. Consignes de sécurité **3. Avvertenze di sicurezza**

	DE	EN	FR	NL	SE	IT	ES
	Warnung vor der Schließbewegung von mechanischen Teilen einer Maschine/Einrichtung	Warning against closing movements for mechanical parts of a machine/device	Danger dû à la fermeture de pièces mécaniques d'une machine / installation	Waarschuwing voor de sluitbeweging van mechanische onderdelen van een machine/voorziening	Varning för stängningsrörelse på mekaniska delar i en maskin/enhet	Prestare attenzione alla chiusura delle parti meccaniche di una macchina o di un dispositivo	Atención, movimiento de cierre de componentes mecánicos en una máquina/instalación
	Warnung vor sich bewegenden mechanischen Teilen	Warning against independently moving parts	Danger dû à des pièces mécaniques mobiles	Waarschuwing voor bewegende mechanische onderdelen	Varning för rörliga mekaniska delar	Prestare attenzione alle parti meccaniche in movimento	Atención, componentes mecánicos en movimiento
	Warnung vor Umkippen durch Schwerpunktverlagerung	Risk of tipping due to displacement of centre of gravity	Attention au basculement lors du déplacement du centre de gravité	Waarschuwing voor kantelen als gevolg van zwaartepuntverschuiving	Varning för vältande föremål på grund av förskjutet tyngdpunkt	Pericolo di cadute tramite lo spostamento del baricentro	Advertencia de vuelco si se desplaza el centro de gravedad
	Warnung vor spitzem Gegenstand	Caution: Sharp object	Attention aux objets pointus	Waarschuwing voor scherpe voorwerpen	Varning för vassa föremål	Pericolo oggetto affilato	Advertencia de objetos puntiagudos
	Warnung vor Hindernissen am Boden	Caution: Obstructions on floor	Attention aux obstacles au sol	Waarschuwing voor obstakels op de grond	Varning för hinder på marken	Pericolo ostacolo in basso	Advertencia de obstáculos en el suelo
	Warnung vor schweren Lasten	Caution: Heavy loads	Attention aux charges lourdes	Waarschuwing voor zware belastingen	Varning för tung last	Pericolo carichi pesanti	Advertencia de cargas pesadas
	Warnung vor Hindernissen im Kopfbereich	Caution: Obstructions in head area	Attention aux obstacles au niveau de la tête	Waarschuwing voor obstakels op hoofdhoogte	Varning för hinder i huvudhöjd	Pericolo ostacolo in alto	Advertencia de obstáculos en la zona de la cabeza
	Die Anleitung ist zu lesen	The instructions must be read	La notice doit être lue	Lees de gebruiksaanwijzing	Bruksanvisningen måste läsas	Leggere le istruzioni	Leer el manual de instrucciones
	Durch Fachmann unterwiesene Person	Individuals who have received specialist instruction	Par une personne formée par un spécialiste	Door specialist getraind persoon	Person instruerad av fackman	Da parte di personale istruito	Persona formada por un experto
	Es gelten auch weiterhin die Sicherheitshinweise zur Bestückung aus der VX IT Montage- und Bedienungsanleitung D-0000-00002192	The safety instructions for configuration as set out in the VX IT assembly and operating instructions D-0000-00002192 remain valid	Les consignes de sécurité pour l'équipement qui figurent dans la notice de montage et d'utilisation VX IT D-0000-00002192 restent en vigueur	De veiligheidsinstructies met betrekking tot de montage, zoals beschreven in de VX IT-montage- en bedieningshandleiding D-0000-00002192, blijven van toepassing	Säkerhetsanvisningarna som anges i VX IT montage- och bruksanvisning D-000000002192 är fortsatt giltiga	Restano valide le istruzioni di sicurezza per l'allestimento riportate nelle istruzioni di montaggio e uso del VX IT D-0000-00002192	Seguirán siendo de aplicación las indicaciones de seguridad para el equipamiento incluidas en las instrucciones de montaje y servicio VX IT D-0000-00002192



3. Turvallisuusohjeet
3. Sikkerhedsanvisninger
3. Wskazówki dotyczące bezpieczeństwa

3. Bezpečnostní pokyny
3. Инструкции за безопасност
3. Меры безопасности

	FI	DK	PL	CZ	BG	RU
	Varoitus koneen/ laitteen mekaanisten osien sulkuilikeestä	Advarsel mod lukkebevægelse af mekaniske dele i en maskine/indretning	Uwaga na zamykające się części mechaniczne lub urządzenia	Výstraha před rizikem úrazu ruky	Предупреждение за движение от затварящи се механични части на машина/оборудване	Предупреждение об опасности при закрывании механических частей машины/установки
	Varoitus liikkuvista mekaanisista osista	Advarsel mod uafhængigt bevægelige dele	Uwaga na ruchome części mechaniczne	Výstraha; Rozmačkání	Предупреждение за движещи се механични части	Предупреждение об опасности движущихся механических частей
	Varo painopisteen siirtymisestä johtuva kaatumisvaara	Risiko for væltning på grund af forskydning af tyngdepunktet	Ostrzeżenie przed przewróceniem się z powodu przesunięcia środka ciężkości	Varování před převrácením způsobeným posunutím těžiště	Предупреждение за опасност от преобръщане поради изместване на центъра на тежестта	Предупреждение об опрокидывании ввиду смещения центра тяжести
	Varo teräviä esineitä	Advarsel: Spidse genstande	Ostrzeżenie przed ostrym przedmiotem	Varování před ostrým předmětem	Предупреждение за опасност от остър предмет	Предупреждение об остром предмете
	Varo kompastumisvaara	Advarsel: Forhindringer på gulvet	Ostrzeżenie przed przeszkodami na podłożu	Varování před překážkami na zemi	Предупреждение за опасност от препятствия по земята	Предупреждение о препятствиях на полу
	Varo raskasta kuormaa	Advarsel: Tunge belastninger	Ostrzeżenie przed dużymi ciężarami	Varování před těžkými břemeny	Предупреждение за опасност от тежки товари	Предупреждение о тяжелых нагрузках
	Varo putoavia esineitä	Advarsel: Forhindringer i hovedhøjde	Ostrzeżenie przed przeszkodami w pobliżu głowy	Varování před překážkami v oblasti hlavy	Предупреждение за опасност от препятствия в областта около главата	Предупреждение о препятствиях в верхней области головы
	Lue käyttöohjeet	Vejlledningen skal læses	Przeczytać instrukcję	Odkaz na instrukce návodu k použití/brožury	Прочетете ръководството	Прочитать руководство
	Vain ammattimaisesti perehdytetyt henkilöt	Person, som er oplært fra fagmand	Osoba przeszkolona przez specjalistę	Osoba zaškolená odborníkem	Инструктирани от специалист лица	Силами обученного персонала
	Noudata myös varustelun turvallisuusohjeita, jotka on mainittu VX IT -asennus- ja käyttöohjeissa D-0000-00002192	Sikkerhedsanvisningarna omkring bestykning i VX IT monterings- og betjeningsvejledningen D-0000-00002192 gælder fortsat	Ponadto obowiązują nadal wskazówki bezpieczeństwa dotyczące wyposażenia z instrukcji montażu i obsługi VX IT D-0000-00002192	I nadále platí také bezpečnostní pokyny pro osazení z návodu k montáži a obsluze VX IT D-0000-00002192	Инструкциите за безопасност от ръководството за монтаж и експлоатация VX IT D-0000-00002192 остават валидни	Действуют меры безопасности при комплектации из Руководства по монтажу и эксплуатации VX IT D-0000-00002192

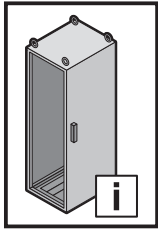

3. Υποδείξεις ασφαλείας
3. Instrucțiuni de siguranță
3. Sigurnosne upute

3. Biztonsági tudnivalók
3. Saugos nurodymai
3. Ohutusteatist

3. Drošības prasības

	GR	RO	HR	HU	LT	EE	LV
	Προειδοποίηση πριν από την κίνηση κλειδώματος μηχανικών μερών μίας εγκατάστασης/μηχανήματος	Avertizare cu privire la mișcare de închidere a pieselor mecanice ale unei mașini/ale unui dispozitiv	Upozorenje na uklopno kretanje mehaničkih dijelova stroja/uređaja	Gép/berendezés mechanikai részeinek zárómozgására történő figyelmeztetés	Įspėjimas dėl mašinos / įrenginio mechaninių dalių judėjimo, užsidarymo metu	Hoiatus masina/ seadme mehhaaniliste osade sulgemisliikumise eest	Uzmanieties iekārtas/mašīnas mehānisko daļu aizvēršanās laikā
	Προειδοποίηση από κινούμενα μηχανικά μέρη	Avertisment cu privire la piesele mecanice aflate în mișcare	Upozorenje na mehaničke dijelove koji su u pokretu	Mozgó mechanikai részekre történő figyelmeztetés	Įspėjimas dėl judančių mechaninių dalių	Hoiatus liikuvate mehhaaniliste osade eest	Uzmanieties no kustīgām mehāniskām daļām
	Προειδοποίηση ανατροπής λόγω μετατόπισης του κέντρου βάρους	Avertizare de răsturnare prin deplasarea centrului de greutate	Upozorenje na prevrtanje zbog pomicanja težišta	Figyelmeztetés a feldőlés veszélyére a súlypont eltolódása miatt	Įspėjimas apie galimą apvirtimą dėl svorio centro perkėlimo	Hoiatus ümberkukkumise eest raskuskeskme nihkumise tõttu	Brīdinājums par apgāšanos smaguma centra novirzīšanās dēļ
	Προειδοποίηση αιχμηρού αντικειμένου	Avertizare privind obiecte ascuțite	Upozorenje na šiljati predmet	Figyelmeztetés hegyes tárgyak veszélyére	Įspėjimas apie aštrų daiktą	Hoiatus terava eseme eest	Brīdinājums par asiem priekšmetiem
	Προειδοποίηση για εμπόδια στο έδαφος	Avertizare privind obstacole la sol	Upozorenje na zapreke na tlu	Figyelmeztetés a padlón található akadályokra	Įspėjimas apie kliūtis ant žemės	Hoiatus põrandal asuvate takistuste eest	Brīdinājums par šķēršļiem uz grīdas
	Προειδοποίηση για βαριά φορτία	Avertizare privind sarcini grele	Upozorenje na teške terete	Figyelmeztetés nehéz teherre	Įspėjimas apie sunkius krovinius	Hoiatus raskete koormate eest	Brīdinājums par lielu slodzi
	Προειδοποίηση για εμπόδια στην περιοχή της κεφαλής	Avertizare privind obstacole în zona capului	Upozorenje na zapreke u području glave	Figyelmeztetés fejmagasságban található akadályokra	Įspėjimas apie kliūtis galvos aukštyje	Hoiatus pea piirkonnas asuvate takistuste eest	Brīdinājums par šķēršļiem galvas zonā
	Απαιτείται το διάβασμα των οδηγιών	A se citi manualul	Pročitajte upute	Az utasítást el kell olvasni	Skaityti instrukciją	Lugeda kasutusjuhendit	Izlasiet instrukciju
	Άτομο που έχει δεχθεί κατάρτιση από εξειδικευμένο τεχνικό	Toți utilizatorii trebuie instruiți de un specialist	Osoba koja je upućena od strane stručnjaka	Szakember által betanított személy	Specialisto išmokytas žmogus	Spetsialisti poolt vālja õpetatud isik	Vadošā speciālista norādījumi
	Ισχύουν οι υποδείξεις ασφαλείας για τον εξοπλισμό, οι οποίες αναφέρονται στις οδηγίες τοποθέτησης και χειρισμού VX IT D-0000-00002192	Trebuie respectate instrucțiunile de siguranță pentru reglarea instalației IT VX și instrucțiunile de operare pentru D-0000-00002192	Sigurnosne upute za montažu naveden u uputama za montažu i rukovanje za VX IT, D-0000-00002192 ostaju važeće	Továbbra is érvényesek a felszereléshez a VX IT szerelési és kezelési útmutatójában (D-0000-00002192) leírt biztonsági előírások	VX IT įrengimo saugos instrukcijos ir naudojimo instrukcijos D-0000-00002192 ir toliau galioja	Kehtivad endiselt ka VX IT montaaži- ja kasutusjuhendis D-0000-00002192 olevad ohutusjuhised kilbi sisustamisel	Joprojām jāņem vērā drošības norādījumi par VX IT uzstādīšanas aprīkojumu un ekspluatācijas instrukcijas D-0000-00002192

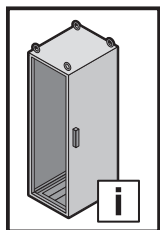

3. Varnostni napotki 3. Bezpečnostné pokyny 3. Instruções de segurança

	SI	SK	PT
	Opozorilo pred zapiranjem mehanskih delov stroja/naprave	Dávajte pozor na zatvárací pohyb mechanických častí stroja/zariadenia	Cuidado quando as partes mecânicas de uma máquina/instalação se fecham
	Opozorilo pred premikajočimi se mehanskimi deli	Dávajte pozor na pohyblivé mechanické časti	Cuidado com as partes mecânicas móveis
	Opozorilo pred prevrnitvijo zaradi spremenjenega težišča	Varovanie pred prevrátením v dôsledku premenenia ťažiska	Cuidado com o risco de queda pelo deslocamento do centro de gravidade
	Opozorilo pred ostrim predmetom	Varovanie pred predmetom s ostrým hrotom	Cuidado com objetos pontiagudos
	Opozorilo pred ovirami na tleh	Varovanie pred prekážkami na podlahe	Cuidado com objetos no chão
	Opozorilo pred težkimi bremenami	Varovanie pred ťažkými bremenami	Cuidado com cargas pesadas
	Opozorilo pred ovirami v višini glave	Varovanie pred prekážkami v priestore hlavy	Cuidado com objeto à altura da cabeça
	Preberite navodila	Prečítajte si návod	Ler as instruções
	Oseba ki jo je poučil strokovnjak	Osoba poučená odborníkom	Pessoa orientada por um especialista técnico
	Še vedno veljajo varnostni napotki za opremljanje v navodilih za montažo in demontažo VX IT D-0000-0002192	Nadálej platia bezpečnostné pokyny týkajúce sa osádzania z návodu na montáž a používanie VX IT D-0000-0002192	As indicações de segurança relativas à instalação que constam no manual de instruções e montagem do VX IT D-0000-0002192 também são válidas

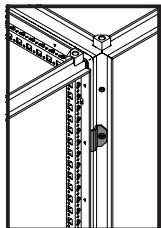

4. Montage Anreihverbinder, außen VX IT
4. Mounting the baying connector, external VX IT
4. Montage des attaches de juxtaposition extérieures VX IT

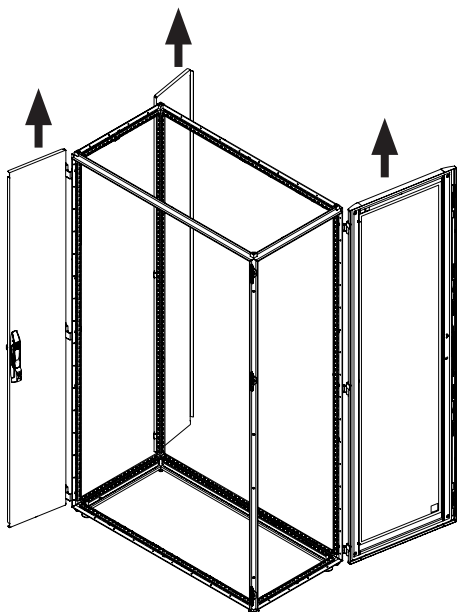

Türen vor Montage aushängen.
Remove doors before installing.
Décrocher les portes avant le montage.

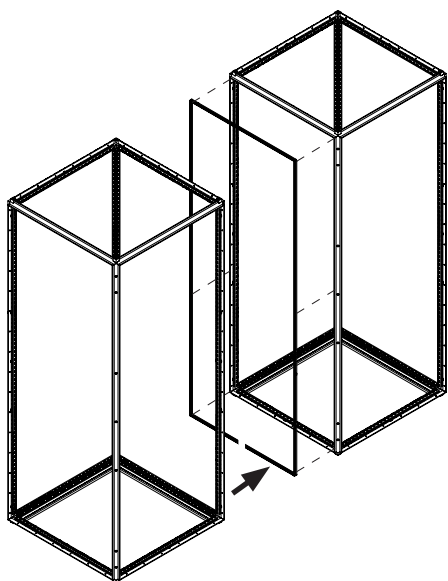

Beim Aufstecken der Anreihdichtung ist darauf zu achten, dass keine Zugkräfte aufgebracht werden.
When fitting the baying seal, ensure that it is not subjected to tensile forces.
Lors de la pose du joint de juxtaposition, il faut veiller à ce qu'il ne subisse aucune force de traction.

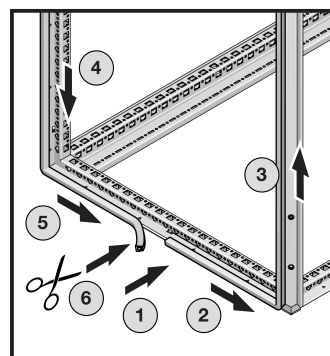

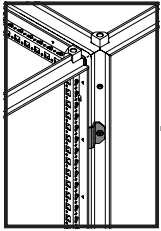

TX30



DE EN FR

4. Montage Anreihverbinder, außen VX IT
4. Mounting the baying connector, external VX IT
4. Montage des attaches de juxtaposition extérieures VX IT

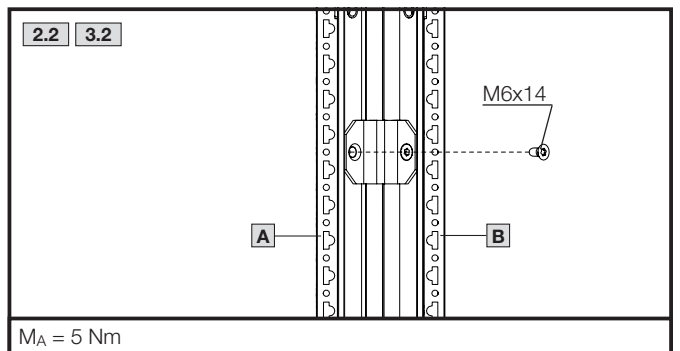
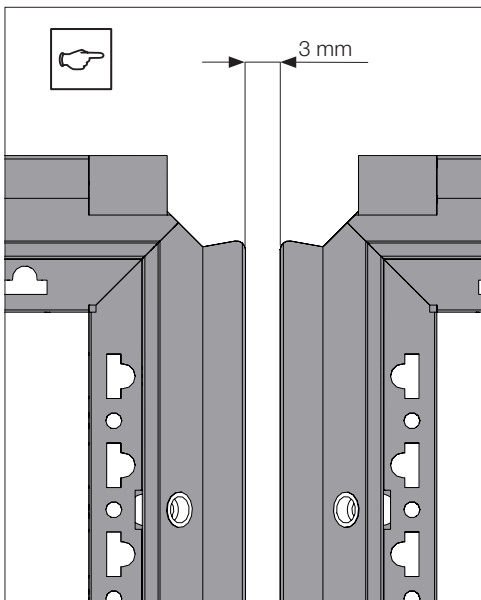
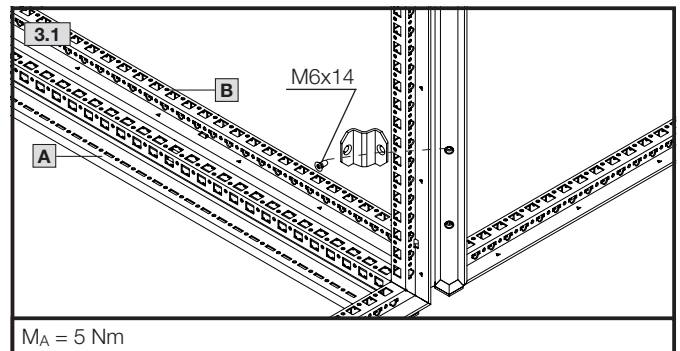
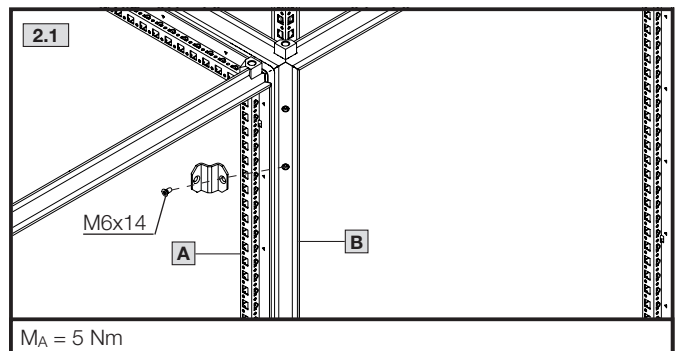
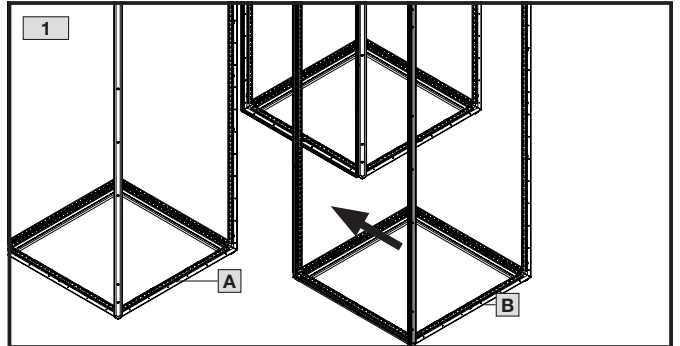
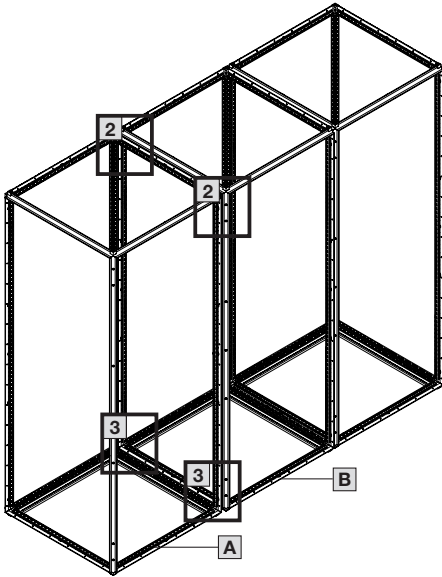

Notizen/Notes

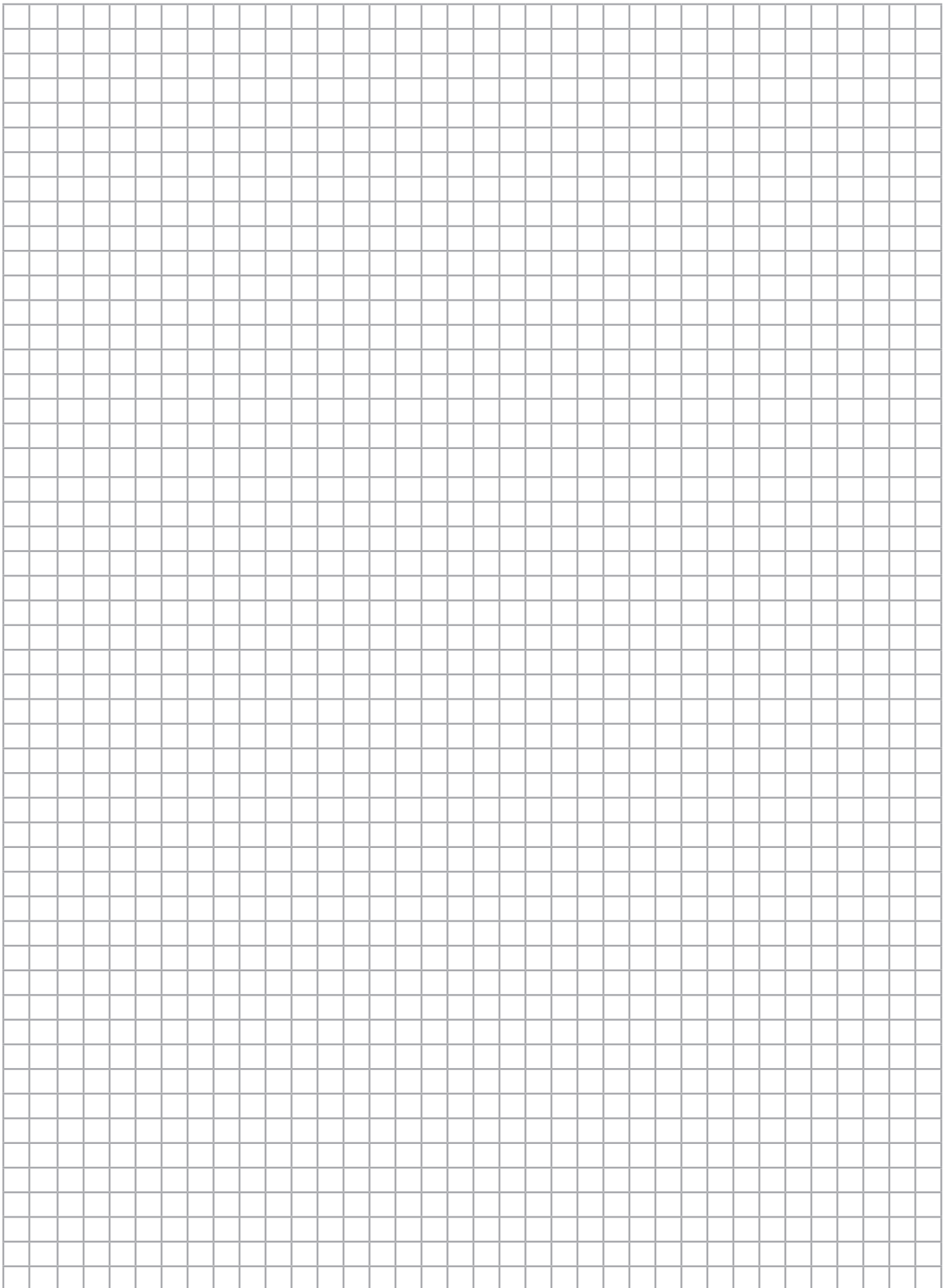

Rittal – The System.

Faster – better – everywhere.

- Enclosures
- Power Distribution
- Climate Control
- IT Infrastructure
- Software & Services



RITTAL GmbH & Co. KG
Auf dem Stuetzelberg · 35745 Herborn · Germany
Phone +49 2772 505-0
E-mail: info@rittal.de · www.rittal.com

09.2020/D-0000-00001837-01

ENCLOSURES

POWER DISTRIBUTION

CLIMATE CONTROL

IT INFRASTRUCTURE

SOFTWARE & SERVICES

FRIEDHELM LOH GROUP

