

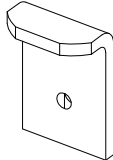

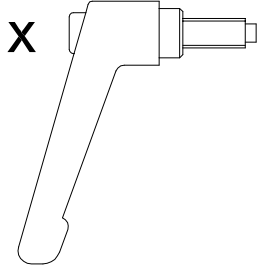



CP
6146.200

Raum für Verpackungsdatum
Area for date of packing
(MMJJTT / MMYDD)

- 1x  1x  M8x20
- 1x  M8
- 2x  M8x20 1x 
- 4x  6x30
- 4x  J6,4
- 1x  M6x10

Zchng.-Nr. / No. of dwg. : A2982803CP

Versandbeutel-Nr. / No. of accessory bag : 288435

Lieferanten-Nr. / No. of supplier :

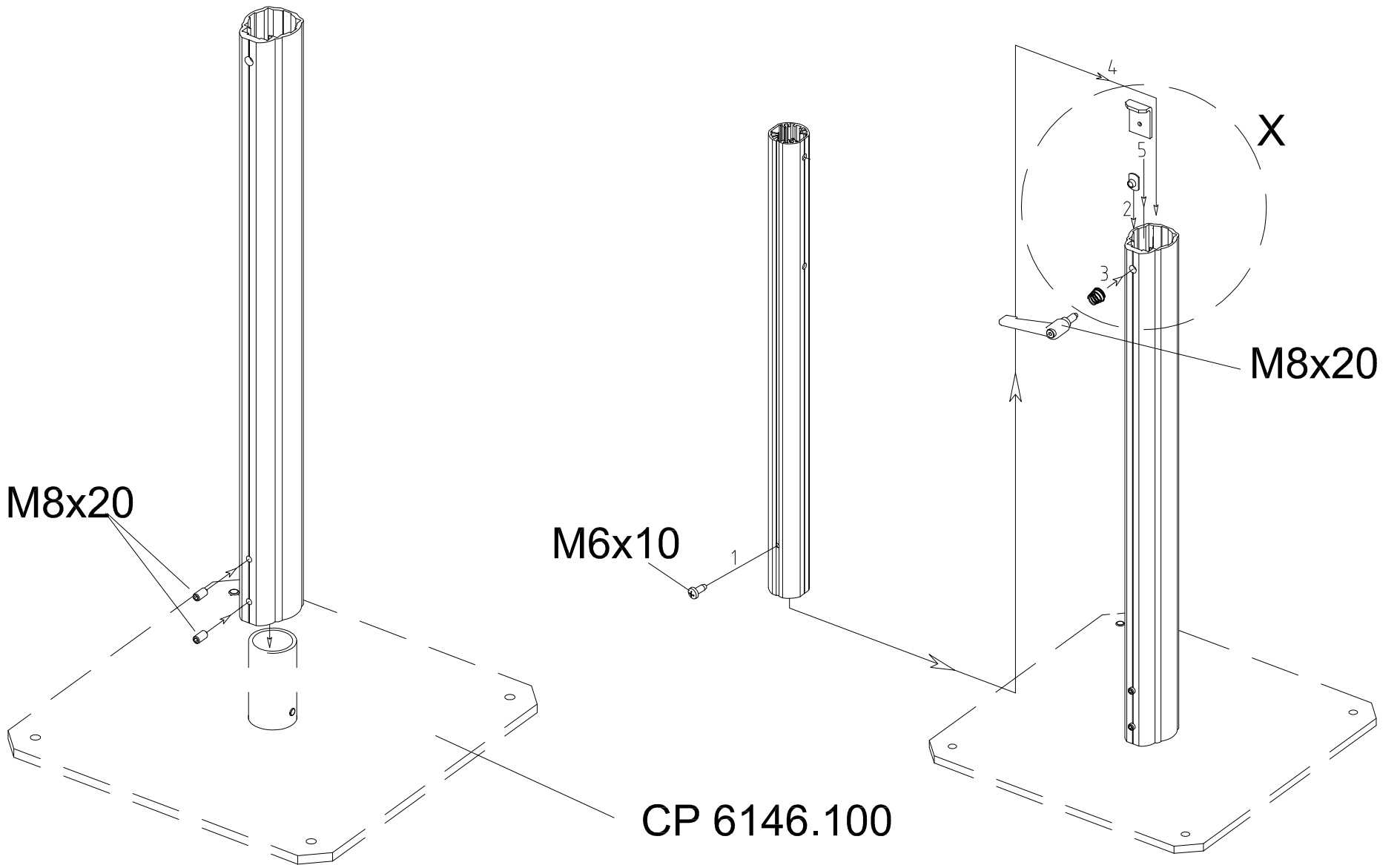

CP 6146.100