

TEMPERATURSICHERUNGEN

TEMPERATURE FUSES



Beschreibung:

Temperatursicherungen sind sicherheitsrelevante Schutzeinrichtungen / Bauteile, die durch das Überschreiten ihrer zulässigen Betriebstemperatur, den Stromkreis sicher unterbrechen.

Die Bemessungstemperatur wird durch die Produktion / den Hersteller bestimmt. Nach dem Auslösen der Temperatursicherung muss diese ersetzt werden, da sie nicht rücksetzbar ist.

Die Temperatursicherungen haben ein formfestes Gehäuse in staub- und schmutzdichter Ausführung. Sie reagieren auf die Umgebungstemperatur und sind bei Nennbelastung bedingt stromempfindlich.

An- und Einbauweise:

Um eine verlustfreie Wärmeübertragung zu gewährleisten, sollte der An- bzw. Einbau direkt an der Wärmequelle erfolgen. Bei Herstellung von Lötverbindungen an den elektrischen Anschlüssen muss auf entsprechende Wärmeableitung (Wärmeleitpaste) geachtet werden. Zusätzlich sollte man ggf. auf gute Austauschbarkeit der Temperatursicherung achten.

Die Sicherungen sind z. T. tränkkladdicht vergossen. Anschlüsse nach Kundenwunsch, z. B. Litze, Draht, Stecker oder Formanschlüsse auf Anfrage möglich.

Vorteile:

- ✓ breite Produktpalette für viele Anwendungen
- ✓ temperaturbeständig
- ✓ hohe Temperaturansprechempfindlichkeit
- ✓ weiter Temperaturbereich
- ✓ kleine Abmessungen
- ✓ einfache Installation
- ✓ verschiedene Anschlussmöglichkeiten

Begriffsdefinition:

Nenn-/ Funktionstemperatur (T_N oder T_F):

Die maximale Temperatur, bei der die Temperatursicherung ihren Leitfähigkeitszustand ändert, um den Stromkreis zu unterbrechen, wobei der Erfassungsstrom die einzige Last ist. Die Nennfunktionstemperatur wird bei einem Temperaturanstieg von ca. 0,5 ° C pro Minute gemessen.

Haltetemperatur (T_H):

Die maximale Temperatur der Temperatursicherung, gemessen am Gehäuseende, bei der die thermische Sicherung 168 Stunden lang ohne Öffnen gehalten werden kann. HINWEIS: Es wird empfohlen, die Sicherungen keinen Dauerbetriebstemperaturen über $T_F - 25$ ° C auszusetzen.

Maximale Grenztemperatur (T_{max}):

Die maximale Temperatur, bei der die Temperatursicherung ihren Leitfähigkeitszustand geändert hat. Diese sollte unter keinen Umständen überschritten werden.

Nennspannung (U_N):

Die maximale Spannung, die an den Stromkreis angelegt werden kann, in dem die thermische Sicherung verwendet wird.

Nennstrom (I_N):

Der maximale Strom, den die Thermosicherung bei der Nennspannung unterbrechen soll.

Description:

Thermal fuses are safety-relevant protective devices / components that reliably interrupt the circuit by exceeding their permissible operating temperature.

The rated temperature is determined by the manufacturer. After triggering the thermal fuse, it must be replaced because it is not resettable.

The temperature fuses have a dimensionally stable housing in dust and dirt-tight design. They react to the ambient temperature and are conditionally sensitive to current at rated load.

Installation:

In order to ensure a loss-free heat transfer, the attachment or installation should be made directly to the heat source. When making solder joints on the electrical connections, attention must be paid to appropriate heat dissipation (heat-conducting pliers).

In addition, you should pay attention to good interchangeability of the temperature fuse if necessary.

The fuses are partly puddle-sealed. Connections according to customer requirements, e.g. Wire, plug or form connections on request.

Advantages:

- ✓ wide product range for many applications and load
- ✓ temperature resistant
- ✓ high temperature response
- ✓ wide temperature range
- ✓ small dimensions
- ✓ simple installation
- ✓ different connection options

Definition of terms:

Nominal functioning temperature (T_N or T_F):

The maximum temperature at which the temperature fuse changes its conduction state to break the circuit, with the sense current being the only load. The nominal operating temperature is measured at a temperature rise of approx. 0.5°C per minute.

Holding temperature (T_H):

The maximum temperature of the temperature fuse, measured at the end of the housing, at which the thermal fuse can be held for 168 hours without opening. NOTE: It is recommended that the fuses not be exposed to continuous operating temperatures above $T_F - 25$ ° C.

Maximum limit temperature (T_{max}):

The maximum temperature at which the thermal fuse has changed its conductivity state. This should under no circumstances be exceeded.

Rated Voltage (U_N):

The maximum voltage that can be applied to the circuit in which the thermal fuse is used.

Rated Current (I_N):

The maximum current that the thermal fuse is rated to interrupt at the rated voltage.

Einsatzgebiete:

Sie finden Anwendung als Temperatursicherung in Elektrogeräten, elektrischen Anlagen und Maschinen, wie z.B.: Elektrische Heizgeräte, Klimaanlage, Transformatoren, Zentralheizungen, Akkumulatoren, Automotive, Steuer – und Messtechnik, Medizintechnik, Labortechnik, Solaranlagen, Haushaltsgeräte.

Applications:

They are used as temperature protection in electrical appliances, electrical installations and machines such as: electric heaters, air conditioners, transformers, central heating systems, accumulators, automotive, control and measurement technology, medical technology, laboratory technology, solar systems, household appliances.

Aufbau / Construction:

770.000 / 765.000 / 761.000

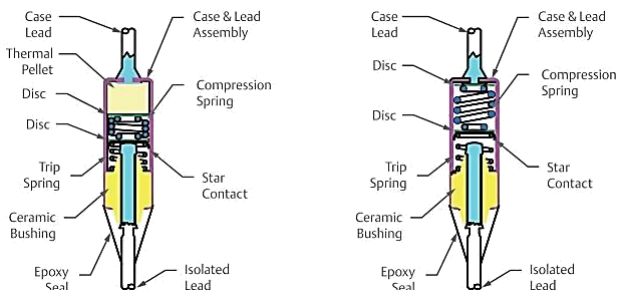

780.000 / 785.000

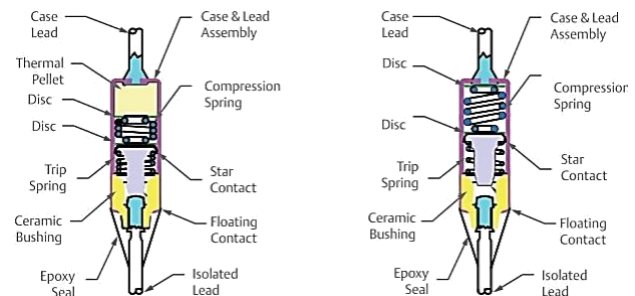

1/2"-Size



Spannung <i>Voltage</i>	120 V / 250 V	Strom <i>Current</i>	10 A / 15 A / 16 A	Typ <i>Type</i>	Autom. Rückstellung Auto Reset
-----------------------------------	----------------------	--------------------------------	---------------------------	---------------------------	---



Schaltzyklen / Switching cycles:

100.000 @ 10 A & 250V / 15 A & 120 V
30.000 @ 16 A & 250V

Anschluss / Terminal:

Flachstecker; 6,3 x 0,8 mm; Messing;
Oberfläche vernickelt; vertikal oder horizontal;
Lötanschluss: Messing, verzinkt /
Blade terminals; 6,3 x 0,8 mm; brass,
Surface nickel-plated; vertical or horizontal;
Solder Terminal: Brass, tin plated

Temperaturgrenzen des Schaltkopfes /
Temperature limits of the switch head:

T_{min}: 0°C
T_{max}: +190°C

Befestigungsmöglichkeiten / Mounting options:

Ohne Flansch / No flange - (36TXE0x)
Anlegeflansch / Docking flange (36TXE1x)
Topflansch / Pot flange (36TXE2x)

Verpackungsmöglichkeiten / Packing options:

500 St. = lose geschüttet in Polybeutel /
500 pcs. = bulk in plastic bag

Weitere Möglichkeiten (leere Felder) auf Anfrage / Additional possibilities (empty fields) on request

Bemessungswerte / Ratings:

Art. No.	Anschluss / Terminal			T _{open} (± 3°C) [°C]	T _{close} (± 4°C) [°C]
	Vertical	Horizontal	Solder		
Öffner – Ohne Flansch / Opener – No flange (Figure 0)					
36TXE01		24562	14784	12,5	4
36TXE01	14545			15	5
36TXE01			22677	25	15
36TXE01	12066			29	7
36TXE01			14952	40	30

Öffner – Topflansch / Opener – Pot flange (Figure 1)					
36TXE11	611828			40	25
36TXE11	611830			50	35
36TXE11	611832	Auf		60	45
36TXE11	611834	Anfrage		70	55
36TXE11	611836			80	65
36TXE11	611838	/		90	75
36TXE11	611839			100	85
36TXE11	611840	On		110	95
36TXE11	611841	request		120	105
36TXE11	611842			130	115
36TXE11	611843			140	125
36TXE11	611844			150	115
36TXE11	611845			160	125
36TXE11	611846			170	135

Öffner – Anlegeflansch / Opener – Docking flange (Figure 2)					
36TXE21				5	-10
36TXE21				8	-5
36TXE21	611896	611922		10	0
36TXE21	611897	611923		15	5
36TXE21	611898	611924		20	10
36TXE21	611899	611925		25	15
36TXE21	611900	611926	Auf	30	20
36TXE21	611901	611927	Anfrage	35	25
36TXE21	611808	611928		40	25
36TXE21	611902	611929	/	45	30
36TXE21	611810	611930		50	35
36TXE21	611903	611931	On	55	40
36TXE21	611812	611932	request	60	45
36TXE21	611904	611933		65	50
36TXE21	611814	611934		70	55
36TXE21	611905	611935		75	60
36TXE21	611816	611936		80	65
36TXE21	611906	611937		85	70
36TXE21	611818	611938		90	75
36TXE21	611907	611939		95	80
36TXE21	611819	611940		100	85
36TXE21	611908	611941		105	90
36TXE21	611820	611942		110	95
36TXE21	611910	611943		120	90
36TXE21	611911	611944		130	100
36TXE21	611912	611945		140	110
36TXE21	611913	611946		150	120
36TXH21	611914	611918		160	120
36TXH21	611915	611919		170	130
36TXH21	611916	611920		180	140
36TXH21	611917	611921		200	160

Art. No.	Anschluss / Terminal			T _{open} (± 3°C) [°C]	T _{close} (± 4°C) [°C]
	Vertical	Horizontal	Solder		
Schliesser – Ohne Flansch / Closer – No flange (Figure 0)					
36TXE02		Auf		4	12,5
36TXE02		Anfrage		5	15
36TXE02		/		15	25
36TXE02		On		7	29
36TXE02		request		30	40

Schliesser – Topflansch / Closer – Pot flange (Figure 1)					
36TXE12	611827			45	60
36TXE12	611829	Auf		55	70
36TXE12	611831	Anfrage		65	80
36TXE12	611833	/		75	90
36TXE12	611835	On		85	100
36TXE12	611837	request		95	110

Schliesser – Anlegeflansch / Closer – Docking flange (Figure 2)					
36TXE22				-10	5
36TXE22				-5	8
36TXE22	611966	611967		25	35
36TXE22	611801	611954		30	45
36TXE22		611955	Auf	35	50
36TXE22	611947	611953	Anfrage	40	55
36TXE22	611957	611949		45	60
36TXE22	611948	611958	/	50	65
36TXE22	611809	611956		55	70
36TXE22	611949	611957	On	60	75
36TXE22	611811	611958	request	65	80
36TXE22	611950	611959		70	85
36TXE22	611813	611960		75	90
36TXE22	611951	611961		80	95
36TXE22	611815	611962		85	100
36TXE22	611952	611963		90	105
36TXE22	611817	611964		95	110

1/2"-Size



Spannung <i>Voltage</i>	120 V / 250 V	Strom <i>Current</i>	10 A / 15 A / 16 A	Typ <i>Type</i>	Autom. Rückstellung Auto Reset
-----------------------------------	----------------------	--------------------------------	---------------------------	---------------------------	---

Ohne Flansch / No flange:

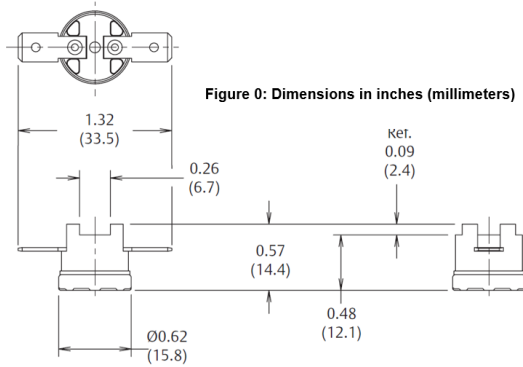

Solder terminals:

0.020 (.5) Crimp / Solder

18 - 20 Ga. Wire



Topflansch / Pot flange:

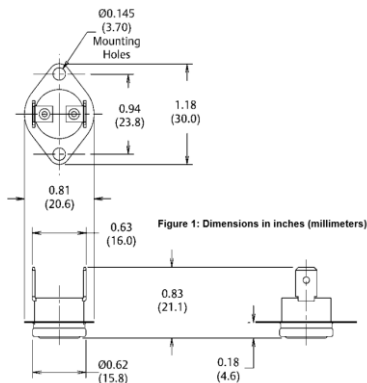

Anlegeflansch / Docking flange:

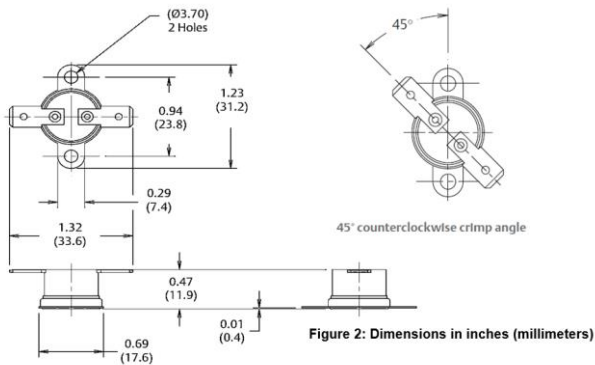

1/2"-Size



Spannung Voltage	120 V / 250 V	Strom Current	10 A / 15 A / 16 A	Type Type	Manuelle Rückstellung Manual Reset
----------------------------	----------------------	-------------------------	---------------------------	---------------------	--



Schaltzyklen / Switching cycles: 100.000 @ 10 A & 250V / 15 A & 120 V
30.000 @ 16 A & 250V

Anschluss / Connection: Flachstecker; 6,3 x 0,8 mm; Messing;
Oberfläche vernickelt; vertikal oder horizontal
Blade terminals; 6,3 x 0,8 mm; brass,
Surface nickel-plated; vertical or horizontal

Temperaturgrenzen des Schaltkopfes /
Temperature limits of the switch head: T_{min}: 0°C
T_{max}: +190°C

Befestigungsmöglichkeiten / Mounting options: Anlegeflansch / Docking flange
Topfflansch / Pot flange

Verpackungsmöglichkeiten / Packing options: 500 St. = lose geschüttet in Polybeutel /
500 pcs. = bulk in plastic bag

Bemessungswerte / Ratings:

Öffner - Anlegeflansch / Opener - Docking flange (Figure 1)		
Art. No.	Anschluss / Connection vertical	T _{open} (± 3°C) [°C]
36TXE26	611847	70
36TXE26	611889	80
36TXE26	611848	85
36TXE26	611888	90
36TXE26	611849	100
36TXE26	611890	110
36TXE26	611850	115
36TXE26	611891	120
36TXE26	611851	130
36TXE26	611892	140
36TXE26	611852	145
36TXE26	611893	150
36TXE26	611853	160
36TXE26	611894	170
36TXE26	611854	175

Öffner - Topfflansch / Opener - Pot flange (Figure 2)		
Art. No.	Anschluss / Connection vertical	T _{open} (± 3°C) [°C]
36TXE16	611855	70
36TXE16	611856	85
36TXE16	611857	100
36TXE16	611858	115
36TXE16	611859	130
36TXE16	611860	145
36TXE16	611861	160
36TXE16	611862	175

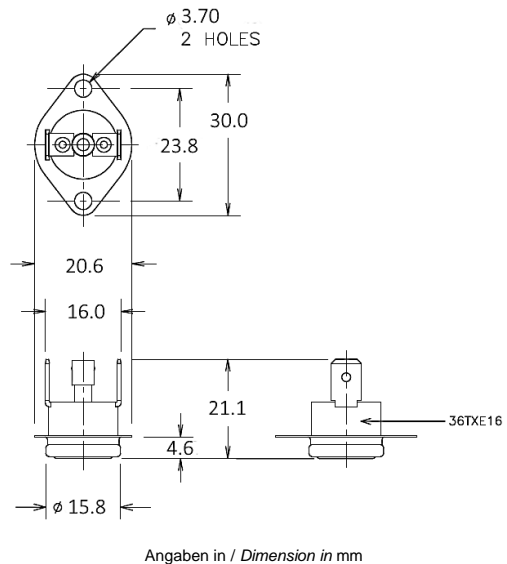
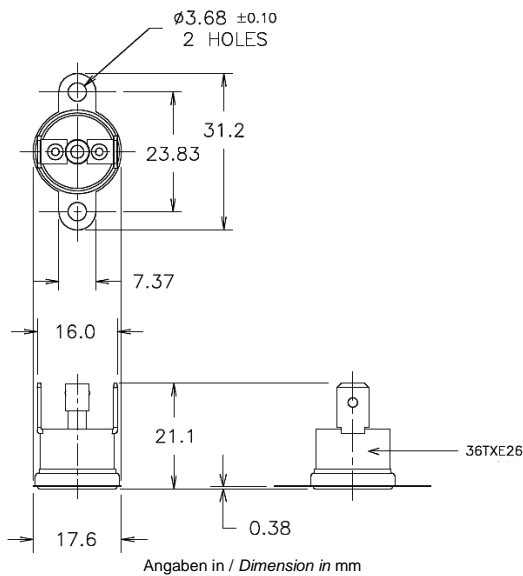

Temperatursicherungen 700.000-S Temperature-Fuses AC



5,2 x 2,3 x 70 mm



Spannung Voltage	250 V	Strom Current	1 A	Typ Type	Radial
----------------------------	--------------	-------------------------	------------	--------------------	---------------

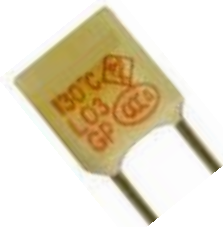

Norm / Standard: IEC 60691

Anschluss / Connection: Rundstifte, Abstand 3,2 mm
Oberfläche verzinnt, steckbar und lötlbar /
Round pins, distance 3,2 mm
Surface tin-plated, pluggable and solderable

Verpackungsmöglichkeiten / Packing options: 100 St. = lose geschüttet in Polybeutel /
100 pcs. = bulk in plastic bag

Bemessungswerte / Ratings:

Art. No.	I _N	U _N [V]	T _N ¹⁾ [°C]	T _H [°C]	T _{max} [°C]	UR	cUR	VDE	TÜV	PSE	CCC	KTL
700.076-S	1 A	250	76	53	200	●	●			●	●	
700.086-S	1 A	250	86	61	200	●	●			●	●	
700.102-S	1 A	250	102	79	200	●	●	●	●	●	●	●
700.115-S	1 A	250	115	91	200	●	●	●	●	●	●	●
700.125-S	1 A	250	125	100	200	●	●	●	●	●	●	●
700.130-S	1 A	250	130	106	200	●	●	●	●	●	●	●
700.133-S	1 A	250	133	111	200	●	●	●		●	●	●
700.145-S	1 A	250	145	121	200	●	●			●		
700.150-S	1 A	250	150	126	200	●	●	●	●	●	●	●
700.160-S	1 A	250	160	135	200					●	●	

¹⁾ Toleranz / Tolerance: +0 / - 10 °C (IEC 60691)

Legende / Caption:

- I_N = Bemessungsstrom / Rated current
- U_N = Bemessungsspannung / Rated voltage
- T_N = Bemessungstemperatur / Rated functioning temp.
- T_H = Haltemperatur / Holding temperature
- T_{max} = max. Grenztemperatur / max. temp. limit

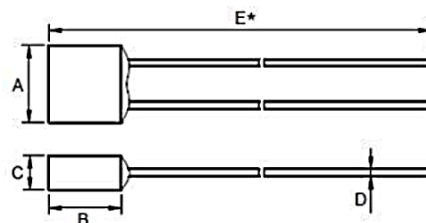

Dimensions (mm)

A	B	C	D	E*
5.2±0.5	4.1±0.5	2.3±0.2	0.50±0.05	60±5

Temperatursicherungen 700.000-X Temperature-Fuses AC

5,2 x 2,3 x 70 mm



Spannung Voltage	250 V	Strom Current	1 A	Typ Type	Radial
----------------------------	--------------	-------------------------	------------	--------------------	---------------

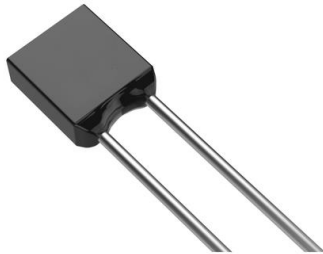

Norm / Standard: IEC 60691

Anschluss / Connection: Rundstifte, Abstand 2,5 mm
Oberfläche verzinnt, steckbar und lötlbar /
Round pins, distance 2,5 mm
Surface tin-plated, pluggable and solderable

Verpackungsmöglichkeiten / Packing options: 100 St. = lose geschüttet in Polybeutel /
100 pcs. = bulk in plastic bag

Bemessungswerte / Ratings:

Art. No.	I _N	U _N [V]	T _N ¹⁾ [°C]	T _H [°C]	T _{max} [°C]	UR	cUR	VDE	PSE	CCC	KTL
700.084-X	1 A	250	84	65	203	●	●	●	●	●	●
700.102-X	1 A	250	102	80	203	●	●	●	●	●	●
700.115-X	1 A	250	115	99	203	●	●	●	●	●	●
700.125-X	1 A	250	125	105	203	●	●	●	●	●	●
700.130-X	1 A	250	130	107	203	●	●	●	●	●	●
700.135-X	1 A	250	135	115	203	●	●	●	●	●	●
700.138-X	1 A	250	138	118	203	●	●	●	●	●	●
700.145-X	1 A	250	145	126	203	●	●	●	●	●	●
700.150-X	1 A	250	150	128	203	●	●	●	●	●	●
700.160-X	1 A	250	160	140	203	●	●	●	●	●	●

¹⁾ Toleranz / Tolerance: +0 / - 10 °C (IEC 60691)

Legende / Caption:

I_N = Bemessungsstrom / Rated current
 U_N = Bemessungsspannung / Rated voltage
 T_N = Bemessungstemperatur / Rated functioning temp.
 T_H = Haltemperatur / Holding temperature
 T_{max} = max. Grenztemperatur / max. temp. limit

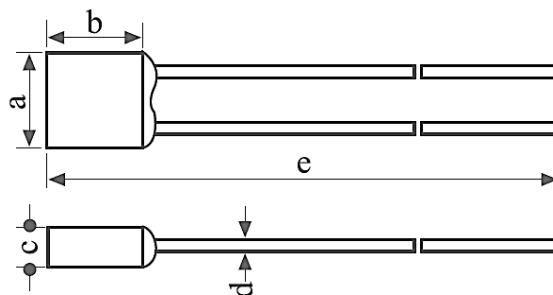

a	b	c	d	e
5,2±0,5	4,0±0,5	2,3±0,2	∅0,54±0,05	70±3

Angaben / Dimension in [mm]

5,8 x 2,3 x 70 mm



Spannung 250 V / 60 V **Strom** 2 A **Typ**
Voltage *Current* *Type* **Radial**



Norm / Standard: IEC 60691
 Anschluss / Connection: Rundstifte, Abstand 3,7 mm
 Oberfläche verzinnt, steckbar und lötlbar /
 Round pins, distance 3,7 mm
 Surface tin-plated, pluggable and solderable
 Verpackungsmöglichkeiten / Packing options: 100 St. = lose geschüttet in Polybeutel /
 100 pcs. = bulk in plastic bag

Bemessungswerte / Ratings:

Art. No.	I _N	U _N (AC / DC) [V]	T _N ¹⁾ [°C]	T _H [°C]	T _{max} [°C]	UR cUR VDE TÜV PSE CCC KTL						
						UR	cUR	VDE	TÜV	PSE	CCC	KTL
710.076-S	2 A	250 AC	76	53	200	•	•			•	•	
710.086-S	2 A	250 AC 60 DC	86	61	200	•	•	•		•	•	•
710.102-S	2 A	250 AC 60 DC	102	79	200	•	•	•	•	•	•	•
710.115-S	2 A	250 AC 60 DC	115	91	200	•	•	•	•	•	•	•
710.125-S	2 A	250 AC 60 DC	125	100	200	•	•	•	•	•	•	•
710.130-S	2 A	250 AC	130	106	200	•	•	•	•	•	•	•
710.133-S	2 A	250 AC	133	111	200	•	•	•		•	•	•
710.135-S	2 A	250 AC	135	111	200	•	•	•		•	•	•
710.136-S	2 A	250 AC	136	112	200	•	•	•		•	•	•
710.145-S	2 A	250 AC	145	121	200	•	•	•		•	•	•
710.150-S	2 A	250 AC	150	126	200	•	•	•	•	•	•	•
710.160-S	2 A	250 AC	160	135	200					•	•	•
710.205-S	2 A	250 AC	205	169	250	•	•		•		•	
710.221-S	2 A	250 AC	221	188	250	•	•		•		•	

¹⁾ Toleranz / Tolerance: +0 / - 10 °C (IEC 60691)

Legende / Caption:

- I_N = Bemessungsstrom / Rated current
- U_N = Bemessungsspannung / Rated voltage
- T_N = Bemessungstemperatur / Rated functioning temp.
- T_H = Haltetemperatur / Holding temperature
- T_{max} = max. Grenztemperatur / max. temp. limit

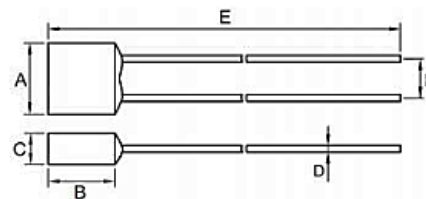

Dimensions (mm)

A	B	C	D(Φ)	E	F*
5.8±0.5	5.8±0.5	2.3±0.2	0.54±0.05	70±3	3.7±0.5

Note: The dimension F is measured from the root of leadwires.

Temperatursicherungen 710.000-X Temperature-Fuses AC

6,2 x 2,5 x 70 mm



Spannung Voltage	250 V	Strom Current	2 A	Typ Type	Radial
----------------------------	--------------	-------------------------	------------	--------------------	---------------

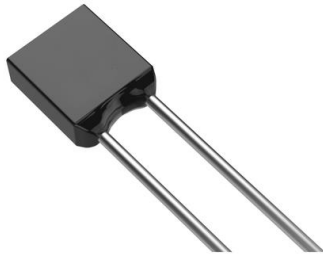

Norm / Standard: IEC 60691

Anschluss / Connection: Rundstifte, Abstand 3,7 mm
Oberfläche verzinnt, steckbar und lötlbar /
Round pins, distance 3,7 mm
Surface tin-plated, pluggable and solderable

Verpackungsmöglichkeiten / Packing options: 100 St. = lose geschüttet in Polybeutel /
100 pcs. = bulk in plastic bag

Bemessungswerte / Ratings:

Art. No.	I _N	U _N [V]	T _N ¹⁾ [°C]	T _H [°C]	T _{max} [°C]	UR	cUR	VDE	PSE	CCC	KTL
710.084-X	2 A	250	84	65	203	●	●	●	●	●	●
710.102-X	2 A	250	102	80	203	●	●	●	●	●	●
710.115-X	2 A	250	115	99	203	●	●	●	●	●	●
710.125-X	2 A	250	125	105	203	●	●	●	●	●	●
710.130-X	2 A	250	130	107	203	●	●	●	●	●	●
710.135-X	2 A	250	135	115	203	●	●	●	●	●	●
710.138-X	2 A	250	138	118	203	●	●	●	●	●	●
710.145-X	2 A	250	145	126	203	●	●	●	●	●	●
710.150-X	2 A	250	150	128	203	●	●	●	●	●	●
710.160-X	2 A	250	160	140	203	●	●	●	●	●	●

¹⁾Toleranz / Tolerance: +0 / - 10 °C (IEC 60691)

Legende / Caption:

- I_N = Bemessungsstrom / Rated current
- U_N = Bemessungsspannung / Rated voltage
- T_N = Bemessungstemperatur / Rated functioning temp.
- T_H = Haltemperatur / Holding temperature
- T_{max} = max. Grenztemperatur / max. temp. limit

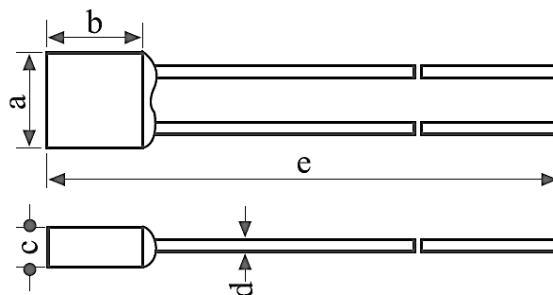

a	b	c	d	e
6,2 ± 0,5	6,3 ± 0,5	2,5 ± 0,3	∅0,54 ± 0,05	70 ± 3

Angaben / Dimension in [mm]

5,8 x 2,3 x 70 mm



Spannung Voltage	250 V / 60 V	Strom Current	3 A	Typ Type	Radial
----------------------------	---------------------	-------------------------	------------	--------------------	---------------



Norm / Standard: IEC 60691

Anschluss / Connection: Rundstifte, Abstand 3,7 mm
 Oberfläche verzinnt, steckbar und lötlbar /
 Round pins, distance 3,7 mm
 Surface tin-plated, pluggable and solderable

Verpackungsmöglichkeiten / Packing options: 100 St. = lose geschüttet in Polybeutel /
 100 pcs. = bulk in plastic bag

Bemessungswerte / Ratings:

Art. No.	I _N	U _N (AC / DC) [V]	T _N ¹⁾ [°C]	T _H [°C]	T _{max} [°C]	UR cUR VDE TÜV PSE CCC KTL						
						UR	cUR	VDE	TÜV	PSE	CCC	KTL
720.076-S	3 A	250 AC	76	53	200	•	•			•	•	
720.086-S	3 A	250 AC 60 DC	86	61	200	•	•	•		•	•	•
720.102-S	3 A	250 AC 60 DC	102	79	200	•	•	•		•	•	•
720.115-S	3 A	250 AC 60 DC	115	91	200	•	•	•		•	•	•
720.125-S	3 A	250 AC 60 DC	125	100	200	•	•	•		•	•	
720.130-S	3 A	250 AC	130	106	200	•	•	•		•	•	•
720.133-S	3 A	250 AC	133	111	200	•	•	•		•	•	•
750.135-S	3 A	250 AC	135	111	200	•	•	•		•	•	•
720.136-S	3 A	250 AC	136	112	200	•	•	•		•	•	•
720.145-S	3 A	250 AC	145	121	200	•	•	•		•	•	•
720.150-S	3 A	250 AC	150	126	200	•	•	•		•	•	•
720.160-S	3 A	250 AC	160	135	200					•	•	
720.205-S	3 A	250 AC	205	169	250	•	•		•		•	•
720.221-S	3 A	250 AC	221	188	250	•	•		•		•	•

¹⁾ Toleranz / Tolerance: +0 / - 10 °C (IEC 60691)

Legende / Caption:

- I_N = Bemessungsstrom / Rated current
- U_N = Bemessungsspannung / Rated voltage
- T_N = Bemessungstemperatur / Rated functioning temp.
- T_H = Haltetemperatur / Holding temperature
- T_{max} = max. Grenztemperatur / max. temp. limit

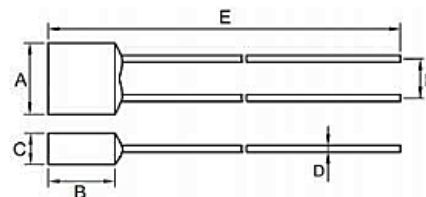

Dimensions (mm)

A	B	C	D(Φ)	E	F*
5.8±0.5	5.8±0.5	2.3±0.2	0.54±0.05	70±3	3.7±0.5

Note: The dimension F is measured from the root of leadwires.

5,8 x 2,3 x 70 mm



Spannung Voltage	250 V / 60 V	Strom Current	3 A	Typ Type	Radial
----------------------------	---------------------	-------------------------	------------	--------------------	---------------



Norm / Standard: IEC 60691

Anschluss / Connection: Rundstifte, Abstand 3,7 mm
 Oberfläche verzinnt, steckbar und lötlbar /
 Round pins, distance 3,7 mm
 Surface tin-plated, pluggable and solderable

Verpackungsmöglichkeiten / Packing options: 100 St. = lose geschüttet in Polybeutel /
 100 pcs. = bulk in plastic bag

Bemessungswerte / Ratings:

Art. No.	I _N	U _N (AC / DC) [V]	T _N ¹⁾ [°C]	T _H [°C]	T _{max} [°C]	UR cUR VDE TÜV PSE CCC KTL						
						UR	cUR	VDE	TÜV	PSE	CCC	KT
720.076-S	3 A	250 AC	76	53	200	●	●			●	●	
720.086-S	3 A	250 AC 60 DC	86	61	200	●	●	●		●	●	●
720.102-S	3 A	250 AC 60 DC	102	79	200	●	●	●		●	●	●
720.115-S	3 A	250 AC 60 DC	115	91	200	●	●	●		●	●	●
720.125-S	3 A	250 AC 60 DC	125	100	200	●	●	●		●	●	
720.130-S	3 A	250 AC	130	106	200	●	●	●		●	●	●
720.133-S	3 A	250 AC	133	111	200	●	●	●		●	●	●
720.135-S	3 A	250 AC	135	111	200	●	●	●		●	●	●
720.136-S	3 A	250 AC	136	112	200	●	●	●		●	●	●
720.145-S	3 A	250 AC	145	121	200	●	●	●		●	●	●
720.150-S	3 A	250 AC	150	126	200	●	●	●		●	●	●
720.160-S	3 A	250 AC	160	135	200					●	●	
720.205-S	3 A	250 AC	205	169	250	●	●		●		●	●
720.221-S	3 A	250 AC	221	188	250	●	●		●		●	●

¹⁾ Toleranz / Tolerance: +0 / - 10 °C (IEC 60691)

Legende / Caption:

- I_N = Bemessungsstrom / Rated current
- U_N = Bemessungsspannung / Rated voltage
- T_N = Bemessungstemperatur / Rated functioning temp.
- T_H = Haltetemperatur / Holding temperature
- T_{max} = max. Grenztemperatur / max. temp. limit

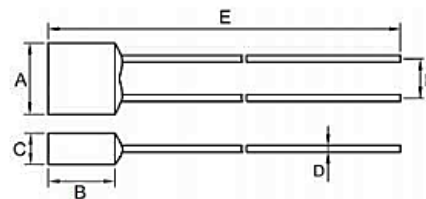

Dimensions (mm)

A	B	C	D (Φ)	E	F*
5.8±0.5	5.8±0.5	2.3±0.2	0.54±0.05	70±3	3.7±0.5

Note: The dimension F is measured from the root of leadwires.

Temperatursicherungen 720.000-X Temperature-Fuses AC



6,2 x 2,5 x 70 mm



Spannung Voltage	250 V	Strom Current	3 A	Typ Type	Radial
----------------------------	--------------	-------------------------	------------	--------------------	---------------

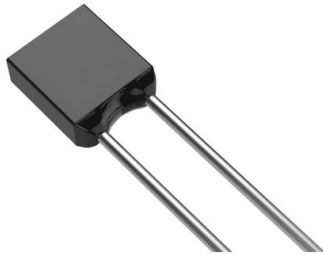

Norm / Standard: IEC 60691

Anschluss / Connection: Rundstifte, Abstand 3,7 mm
Oberfläche verzinnt, steckbar und lötlbar /
Round pins, distance 3,7 mm
Surface tin-plated, pluggable and solderable

Verpackungsmöglichkeiten / Packing options: 100 St. = lose geschüttet in Polybeutel /
100 pcs. = bulk in plastic bag

Bemessungswerte / Ratings:

Art. No.	I _N	U _N [V]	T _N ¹⁾ [°C]	T _H [°C]	T _{max} [°C]	UR	cUR	VDE	PSE	CCC	KTL
720.084-X	3 A	250	84	65	203	●	●	●	●	●	●
720.102-X	3 A	250	102	80	203	●	●	●	●	●	●
720.115-X	3 A	250	115	99	203	●	●	●	●	●	●
720.125-X	3 A	250	125	105	203	●	●	●	●	●	●
720.130-X	3 A	250	130	107	203	●	●	●	●	●	●
720.135-X	3 A	250	135	115	203	●	●	●	●	●	●
720.138-X	3 A	250	138	118	203	●	●	●	●	●	●
720.145-X	3 A	250	145	126	203	●	●	●	●	●	●
720.150-X	3 A	250	150	128	203	●	●	●	●	●	●
720.160-X	3 A	250	160	140	203	●	●	●	●	●	●

¹⁾ Toleranz / Tolerance: +0 / - 10 °C (IEC 60691)

Legende / Caption:

- I_N = Bemessungsstrom / Rated current
- U_N = Bemessungsspannung / Rated voltage
- T_N = Bemessungstemperatur / Rated functioning temp.
- T_H = Haltemperatur / Holding temperature
- T_{max} = max. Grenztemperatur / max. temp. limit

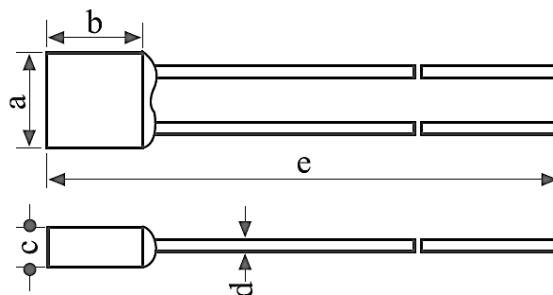

a	b	c	d	e
6,2 ± 0,5	6,3 ± 0,5	2,5 ± 0,3	∅0,54 ± 0,05	70 ± 3

Angaben / Dimension in [mm]

Temperatursicherungen 730.000-S Temperature-Fuses AC



7,0 x 2,7 x 70 mm



Spannung Voltage	250 V	Strom Current	5 A	Typ Type	Radial
----------------------------	--------------	-------------------------	------------	--------------------	---------------

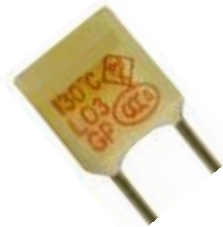

Norm / Standard: IEC 60691

Anschluss / Connection: Rundstifte, Abstand 4,0 mm
Oberfläche verzinnt, steckbar und lötlbar /
Round pins, distance 4,0 mm
Surface tin-plated, pluggable and solderable

Verpackungsmöglichkeiten / Packing options: 100 St. = lose geschüttet in Polybeutel /
100 pcs. = bulk in plastic bag

Bemessungswerte / Ratings:

Art. No.	I _N	U _N [V]	T _N ¹⁾ [°C]	T _H [°C]	T _{max} [°C]	UR	cUR	VDE	PSE	CCC	KTL
730.076-S	5 A	250	76	53	200	●	●		●	●	
730.086-S	5 A	250	86	61	200	●	●		●	●	
730.102-S	5 A	250	102	77	200	●	●		●	●	
730.115-S	5 A	250	115	89	200	●	●	●	●	●	●
730.125-S	5 A	250	125	98	200	●	●	●	●	●	●
730.130-S	5 A	250	130	103	200	●	●	●	●	●	●
730.133-S	5 A	250	133	108	200	●	●	●	●	●	●
730.136-S	5 A	250	136	11	200	●	●	●	●	●	●
730.145-S	5 A	250	145	118	200	●	●		●	●	
730.150-S	5 A	250	150	123	200	●	●	●	●	●	●
730.160-S	5 A	250	160	133	200				●	●	

¹⁾Toleranz / Tolerance: +0 / - 10 °C (IEC 60691)

Legende / Caption:

- I_N = Bemessungsstrom / Rated current
- U_N = Bemessungsspannung / Rated voltage
- T_N = Bemessungstemperatur / Rated functioning temp.
- T_H = Haltezeittemperatur / Holding temperature
- T_{max} = max. Grenztemperatur / max. temp. limit

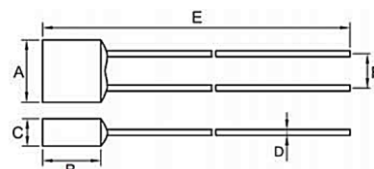

Dimensions (mm)

A	B	C	D(Φ)	E	F*
6.6±0.5	7.0±0.5	2.7±0.3	0.80±0.05	70±3	4.0±0.5

6,6 x 2,6 x 70 mm



Spannung Voltage	250 V	Strom Current	5 A	Typ Type	Radial
----------------------------	--------------	-------------------------	------------	--------------------	---------------

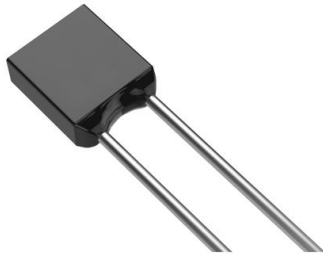

Norm / Standard: IEC 60691

Anschluss / Connection: Rundstifte, Abstand 3,7 mm
 Oberfläche verzinnt, steckbar und lötlbar /
 Round pins, distance 3,7 mm
 Surface tin-plated, pluggable and solderable

Verpackungsmöglichkeiten / Packing options: 100 St. = lose geschüttet in Polybeutel /
 100 pcs. = bulk in plastic bag

Bemessungswerte / Ratings:

Art. No.	I _N	U _N [V]	T _N ¹⁾ [°C]	T _H [°C]	T _{max} [°C]	UR	cUR	VDE	PSE	CCC	KTL
730.084-X	5 A	250	84	65	203	●	●	●	●	●	●
730.102-X	5 A	250	102	80	203	●	●	●	●	●	●
730.115-X	5 A	250	115	95	203	●	●	●	●	●	●
730.125-X	5 A	250	125	105	203	●	●	●	●	●	●
730.130-X	5 A	250	130	107	203	●	●	●	●	●	●
730.135-X	5 A	250	135	115	203	●	●	●	●	●	●
730.138-X	5 A	250	138	115	203	●	●	●	●	●	●
730.145-X	5 A	250	145	126	203	●	●	●	●	●	●
730.150-X	5 A	250	150	128	203	●	●	●	●	●	●
730.160-X	5 A	250	160	135	203	●	●	●	●	●	●

¹⁾ Toleranz / Tolerance: +0 / - 10 °C (IEC 60691)

Legende / Caption:

- I_N = Bemessungsstrom / Rated current
- U_N = Bemessungsspannung / Rated voltage
- T_N = Bemessungstemperatur / Rated functioning temp.
- T_H = Haltemperatur / Holding temperature
- T_{max} = max. Grenztemperatur / max. temp. limit

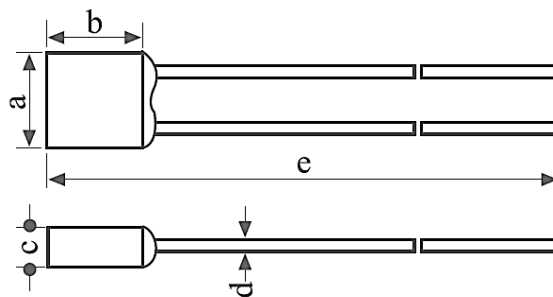

a	b	c	d	e
6,6 ± 0,5	8,0 ± 0,5	2,6 ± 0,3	∅0,6 ± 0,02	70 ± 3

Angaben / Dimension in [mm]

Temperatursicherungen 731.000-X Temperature-Fuses AC



8,3 x 3,4 x 45 mm



Spannung Voltage	250 V	Strom Current	10 A	Typ Type	Radial
----------------------------	--------------	-------------------------	-------------	--------------------	---------------

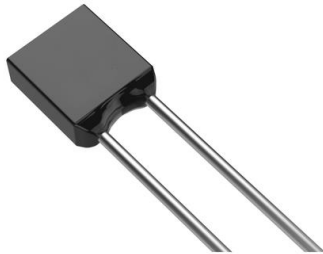

Norm / Standard: IEC 60691

Anschluss / Connection: Rundstifte, Abstand 5,0 mm
Oberfläche verzinnt, steckbar und lötlbar /
Round pins, distance 5,0 mm
Surface tin-plated, pluggable and solderable

Verpackungsmöglichkeiten / Packing options: 100 St. = lose geschüttet in Polybeutel /
100 pcs. = bulk in plastic bag

Bemessungswerte / Ratings:

Art. No.	I _N	U _N [V]	T _N ¹⁾ [°C]	T _H [°C]	T _{max} [°C]	UR	cUR	VDE	CCC
731.102-X	10 A	250	102	72	203	●	●	●	
731.115-X	10 A	250	115	85	203	●	●	●	●
731.130-X	10 A	250	130	100	203	●	●	●	●
731.135-X	10 A	250	135	106	203	●	●	●	
731.138-X	10 A	250	138	109	203	●	●	●	

¹⁾ Toleranz / Tolerance: +0 / - 10 °C (IEC 60691)

Legende / Caption:

- I_N = Bemessungsstrom / Rated current
- U_N = Bemessungsspannung / Rated voltage
- T_N = Bemessungstemperatur / Rated functioning temp.
- T_H = Haltemperatur / Holding temperature
- T_{max} = max. Grenztemperatur / max. temp. limit

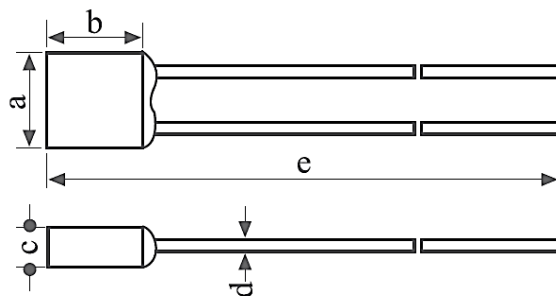

a	b	c	d	e
8.3 ± 0.5	7.5 ± 0.5	3.4 ± 0.3	F1.0 ± 0.05	45 ± 3

Angaben / Dimension in [mm]

Ø 2,1 x 6,5 mm



Spannung 50 V - 250 V **Strom** 1 A **Typ** Axial
Voltage *Current* *Type*



Norm / Standard: IEC 60691
Anschluss / Connection: Rundstifte, Oberfläche verzinnt, steckbar und lötfar / Round pins, Surface tin-plated, pluggable and solderable
Verpackungsmöglichkeiten / Packing options: 100 St. = lose geschüttet in Polybeutel / 100 pcs. = bulk in plastic bag

Bemessungswerte / Ratings:

Art. No.	I _N	U _N [V]	T _N ¹⁾ [°C]	T _H [°C]	T _{max} [°C]	UR	cUR	TÜV	PSE	CCC	KTL
						●	●	●	●	●	●
735.076-S	1 A	250 AC 125 AC 50 DC	76	53	200	●	●	●	●	●	●
735.086-S	1 A	250 AC 125 AC 50 DC	86	61	200	●	●	●	●	●	●
735.097-S	1 A	125 AC 50 DC	97	70	200	●	●	●	●	●	●
735.102-S	1 A	250 AC 125 AC 50 DC	102	79	200	●	●	●	●	●	●
735.115-S	1 A	250 AC 50 DC	115	91	200	●	●	●	●	●	●
735.125-S	1 A	250 AC 50 DC	125	100	200	●	●	●	●	●	●
735.130-S	1 A	250 AC 50 DC	130	106	200	●	●	●	●	●	●
735.133-S	1 A	250 AC 50 DC	133	111	200	●	●	●	●	●	●
735.135-S	1 A	250 AC 50 DC	135	111	200	●	●	●	●	●	●
735.136-S	1 A	250 AC 50 DC	136	112	200	●	●	●	●	●	●
735.139-S	1 A	250 AC 50 DC	139	115	200	●	●	●	●	●	●
735.145-S	1 A	250 AC 50 DC	145	121	200	●	●	●	●	●	●
735.150-S	1 A	250 AC 50 DC	150	126	200	●	●	●	●	●	●

¹⁾ Toleranz / Tolerance: +0 / - 10 °C (IEC 60691)

Legende / Caption:

- I_N = Bemessungsstrom / Rated current
- U_N = Bemessungsspannung / Rated voltage
- T_N = Bemessungstemperatur / Rated functioning temp.
- T_H = Haltetemperatur / Holding temperature
- T_{max} = max. Grenztemperatur / max. temp. limit

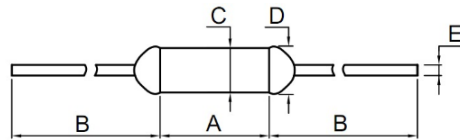

Dimensions (mm)

A	B	C (Φ)	D	E (Φ)
6.5±0.5	37±3	2.1±0.5	≤2.6	0.5±0.05

Temperatursicherungen 735.000-X Temperature-Fuses AC



Ø 2,4 x 6,5 mm



Spannung Voltage	250 V	Strom Current	1 A	Typ Type	Axial
----------------------------	--------------	-------------------------	------------	--------------------	--------------



Norm / Standard: IEC 60691

Anschluss / Connection: Rundstifte, Oberfläche verzinnt, steckbar und lötfar / Round pins, Surface tin-plated, pluggable and solderable

Verpackungsmöglichkeiten / Packing options: 100 St. = lose geschüttet in Polybeutel / 100 pcs. = bulk in plastic bag

Bemessungswerte / Ratings:

Art. No.	I _N	U _N [V]	T _N ¹⁾ [°C]	T _H [°C]	T _{max} [°C]	UR	cUR	VDE	PSE	CCC	KTL
735.102-X	1 A	250	102	80	200	●	●	●	●	●	●
735.115-X	1 A	250	115	99	200	●	●	●	●	●	●
735.125-X	1 A	250	125	105	200	●	●	●	●	●	●
735.130-X	1 A	250	130	107	200	●	●	●	●	●	●
735.135-X	1 A	250	135	115	200	●	●	●	●	●	●
735.138-X	1 A	250	138	118	200	●	●	●	●	●	●
735.145-X	1 A	250	145	126	200	●	●	●	●	●	●
735.150-X	1 A	250	150	128	200	●	●	●	●	●	●
735.223-X	1 A	250	223	190	280	●	●	●	●	●	●

¹⁾ Toleranz / Tolerance: +0 / - 10 °C (IEC 60691)

Legende / Caption:

- I_N = Bemessungsstrom / Rated current
- U_N = Bemessungsspannung / Rated voltage
- T_N = Bemessungstemperatur / Rated functioning temp.
- T_H = Haltetemperatur / Holding temperature
- T_{max} = max. Grenztemperatur / max. temp. limit

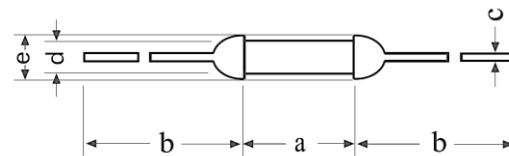

a	b	c	d	e
6.5 ± 0.5	38 ± 3	Ø0.54 ± 0.05	Ø 2.1 ± 0.1	2.4 or below

Angaben / Dimension in [mm]

Ø 2,5 x 9,0 mm



Spannung 50 V - 250 V **Strom** 2 A **Typ** Axial
Voltage **Current** **Type**



Norm / Standard: IEC 60691
 Anschluss / Connection: Rundstifte, Oberfläche verzinnt, steckbar und lötfar / Round pins, Surface tin-plated, pluggable and solderable
 Verpackungsmöglichkeiten / Packing options: 100 St. = lose geschüttet in Polybeutel / 100 pcs. = bulk in plastic bag

Bemessungswerte / Ratings:

Art. No.	I _N	U _N [V]	T _N ¹⁾ [°C]	T _H [°C]	T _{max} [°C]	UR	cUR	TÜV	PSE	CCC	KTL
740.076-S	2 A	250 AC 125 AC 50 DC	76	53	200	•	•				
740.086-S	2 A	250 AC 125 AC 50 DC	86	61	200	•	•	•	•	•	•
740.097-S	2 A	125 AC 50 DC	97	70	200	•	•				
740.102-S	2 A	250 AC 125 AC 50 DC	102	79	200	•	•		•	•	•
740.115-S	2 A	250 AC 50 DC	115	91	200	•	•	•	•	•	•
740.125-S	2 A	250 AC 50 DC	125	100	200	•	•	•	•	•	•
740.130-S	2 A	250 AC 50 DC	130	106	200	•	•	•	•	•	•
740.133-S	2 A	250 AC 50 DC	133	111	200	•	•	•	•	•	•
740.135-S	2 A	250 AC 50 DC	135	111	200	•	•	•	•	•	•
740.136-S	2 A	250 AC 50 DC	136	112	200	•	•	•	•	•	•
740.139-S	2 A	250 AC 50 DC	139	115	200	•	•	•	•	•	•
740.145-S	2 A	250 AC 50 DC	145	121	200	•	•	•	•	•	•
740.150-S	2 A	250 AC 50 DC	150	126	200	•	•	•	•	•	•
740.205-S	2 A	250 AC 125 AC 60 DC	205	169	250	•	•	•		•	•
740.221-S	2 A	250 AC 125 AC 60 DC	221	188	250	•	•	•		•	•

¹⁾ Toleranz / Tolerance: +0 / - 10 °C (IEC 60691)

Legende / Caption:

- I_N = Bemessungsstrom / Rated current
- U_N = Bemessungsspannung / Rated voltage
- T_N = Bemessungstemperatur / Rated functioning temp.
- T_H = Haltetemperatur / Holding temperature
- T_{max} = max. Grenztemperatur / max. temp. limit

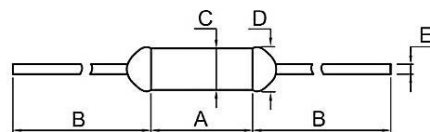

Dimensions (mm)

A	B	C(Φ)	D	E(Φ)
9±0.5	36±3	2.5±0.5	≤3.0	0.54±0.05

Temperatursicherungen 740.000-X Temperature-Fuses AC



Ø 3,0 x 9,0 mm



Spannung Voltage	250 V	Strom Current	2 A	Typ Type	Axial
----------------------------	--------------	-------------------------	------------	--------------------	--------------



Norm / Standard: IEC 60691

Anschluss / Connection: Rundstifte, Oberfläche verzinnt, steckbar und lötfähig / Round pins, Surface tin-plated, pluggable and solderable

Verpackungsmöglichkeiten / Packing options: 100 St. = lose geschüttet in Polybeutel / 100 pcs. = bulk in plastic bag

Bemessungswerte / Ratings:

Art. No.	I _N	U _N [V]	T _N ¹⁾ [°C]	T _H [°C]	T _{max} [°C]	UR	cUR	VDE	PSE	CCC	KTL
740.102-X	2 A	250	102	80	200	●	●	●	●	●	●
740.115-X	2 A	250	115	99	200	●	●	●	●	●	●
740.125-X	2 A	250	125	105	200	●	●	●	●	●	●
740.130-X	2 A	250	130	107	200	●	●	●	●	●	●
740.135-X	2 A	250	135	115	200	●	●	●	●	●	●
740.138-X	2 A	250	138	118	200	●	●	●	●	●	●
740.145-X	2 A	250	145	126	200	●	●	●	●	●	●
740.150-X	2 A	250	150	128	200	●	●	●	●	●	●
740.223-X	2 A	250	223	190	280	●	●	●	●	●	●

¹⁾ Toleranz / Tolerance: +0 / - 10 °C (IEC 60691)

Legende / Caption:

- I_N = Bemessungsstrom / Rated current
- U_N = Bemessungsspannung / Rated voltage
- T_N = Bemessungstemperatur / Rated functioning temp.
- T_H = Haltetemperatur / Holding temperature
- T_{max} = max. Grenztemperatur / max. temp. limit

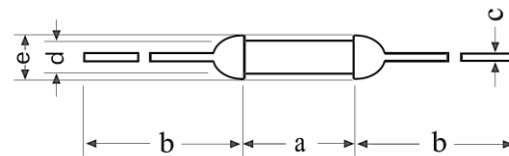

a	b	c	d	e
9,0±0,5	38±3	Ø0,54±0,05	Ø2,5±0,1	3,0 or below

Angaben / Dimension in [mm]

Ø 3,0 x 10,0 mm



Spannung 50 V - 250 V **Strom** 3 A **Typ** Axial
Voltage *Current* *Type*



Norm / Standard: IEC 60691
Anschluss / Connection: Rundstifte, Oberfläche verzinnt, steckbar und lötlbar / Round pins, Surface tin-plated, pluggable and solderable
Verpackungsmöglichkeiten / Packing options: 100 St. = lose geschüttet in Polybeutel / 100 pcs. = bulk in plastic bag

Bemessungswerte / Ratings:

Art. No.	I _N	U _N [V]	T _N ¹⁾ [°C]	T _H [°C]	T _{max} [°C]	UR	cUR	TÜV	PSE	CCC	KTL
750.076-S	3 A	250 AC 125 AC 50 DC	76	53	200	•	•				
750.086-S	3 A	250 AC 125 AC 50 DC	86	61	200	•	•	•	•	•	•
750.097-S	3 A	125 AC 50 DC	97	70	200	•	•				
750.102-S	3 A	250 AC 125 AC 50 DC	102	79	200	•	•	•	•	•	•
750.115-S	3 A	250 AC 50 DC	115	91	200	•	•	•	•	•	•
750.125-S	3 A	250 AC 50 DC	125	100	200	•	•	•	•	•	•
750.130-S	3 A	250 AC 50 DC	130	106	200	•	•	•	•	•	•
750.133-S	3 A	250 AC 50 DC	133	111	200	•	•	•	•	•	•
750.135-S	3 A	250 AC 50 DC	135	111	200	•	•	•	•	•	•
750.136-S	3 A	250 AC 50 DC	136	112	200	•	•	•	•	•	•
750.139-S	3 A	250 AC 50 DC	139	115	200	•	•	•	•	•	•
750.145-S	3 A	250 AC 50 DC	145	121	200	•	•	•	•	•	•
750.150-S	3 A	250 AC 50 DC	150	126	200	•	•	•	•	•	•
750.205-S	3 A	250 AC 60 DC	205	169	250	•	•	•	•	•	•
750.221-S	3 A	125 AC 60 DC	221	188	250	•	•	•			•

¹⁾ Toleranz / Tolerance: +0 / - 10 °C (IEC 60691)

Legende / Caption:

- I_N = Bemessungsstrom / Rated current
- U_N = Bemessungsspannung / Rated voltage
- T_N = Bemessungstemperatur / Rated functioning temp.
- T_H = Haltezeittemperatur / Holding temperature
- T_{max} = max. Grenztemperatur / max. temp. limit

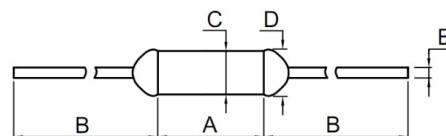

Dimensions (mm)

A	B	C(Φ)	D	E(Φ)
10±0.5	35±3	3.0±0.5	≤3.5	0.54±0.05

Temperatursicherungen 750.000-X Temperature-Fuses AC



Ø 3,3 x 10,0 mm



Spannung Voltage	250 V	Strom Current	3 A	Typ Type	Axial
----------------------------	--------------	-------------------------	------------	--------------------	--------------



Norm / Standard:	IEC 60691
Anschluss / Connection:	Rundstifte, Oberfläche verzinnt, steckbar und lötlbar / Round pins, Surface tin-plated, pluggable and solderable
Verpackungsmöglichkeiten / Packing options:	100 St. = lose geschüttet in Polybeutel / 100 pcs. = bulk in plastic bag

Bemessungswerte / Ratings:

Art. No.	I _N	U _N [V]	T _N ¹⁾ [°C]	T _H [°C]	T _{max} [°C]	UR	cUR	VDE	PSE	CCC	KC
750.084-X	3 A	250	84	65	200	●	●	●	●	●	●
750.102-X	3 A	250	102	80	200	●	●	●	●	●	●
750.115-X	3 A	250	115	99	200	●	●	●	●	●	●
750.125-X	3 A	250	125	105	200	●	●	●	●	●	●
750.130-X	3 A	250	130	107	200	●	●	●	●	●	●
750.135-X	3 A	250	135	115	200	●	●	●	●	●	●
750.138-X	3 A	250	138	118	200	●	●	●	●	●	●
750.145-X	3 A	250	145	126	200	●	●	●	●	●	●
750.150-X	3 A	250	150	128	200	●	●	●	●	●	●

¹⁾ Toleranz / Tolerance: +0 / - 10 °C (IEC 60691)

Legende / Caption:

- I_N = Bemessungsstrom / Rated current
- U_N = Bemessungsspannung / Rated voltage
- T_N = Bemessungstemperatur / Rated functioning temp.
- T_H = Haltetemperatur / Holding temperature
- T_{max} = max. Grenztemperatur / max. temp. limit

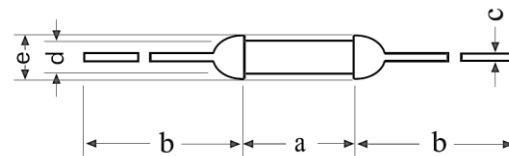

a	b	c	d	e
10,0±0,5	38±3	Ø0,6±0,02	Ø3,0±0,1	3,3 or below

Angaben / Dimension in [mm]

Ø 3,8 x 11,5 mm



Spannung 50 V - 250 V **Strom** 5 A - 7 A **Typ** Axial
Voltage **Current** **Type**



Norm / Standard: IEC 60691
 Anschluss / Connection: Rundstifte, Oberfläche verzinnt, steckbar und lötfar / Round pins, Surface tin-plated, pluggable and solderable
 Verpackungsmöglichkeiten / Packing options: 100 St. = lose geschüttet in Polybeutel / 100 pcs. = bulk in plastic bag

Bemessungswerte / Ratings:

Art. No.	I _N	U _N [V]	T _N ¹⁾ [°C]	T _H [°C]	T _{max} [°C]	UR	cUR	TÜV	PSE	CCC	KTL
755.076-S	5 A	250 AC	76	53	200			•	•	•	•
755.086-S	5A	250 AC 125 AC 50 DC	86	61	200	•	•	•	•	•	•
755.097-S	5 A	125 AC 50 DC	97	70	200	•	•				
755.102-S	5 A	250 AC 125 AC 50 DC	102	77	200	•	•	•	•	•	•
755.115-S	5 A 7 A	250 AC 50 DC	115	89	200	•	•	•	•	•	•
755.125-S	5 A 7 A	250 AC 50 DC	125	98	200	•	•	•	•	•	•
755.130-S	5 A 7 A	250 AC 50 DC	130	103	200	•	•	•	•	•	•
755.133-S	5 A 7 A	250 AC 50 DC	133	108	200	•	•	•	•	•	•
755.135-S	5 A 7 A	250 AC 50 DC	135	111	200	•	•	•	•	•	•
755.136-S	5 A 7 A	250 AC 50 DC	136	111	200	•	•	•	•	•	•
755.139-S	5 A 7 A	250 AC 50 DC	139	112	200	•	•	•	•	•	•
755.145-S	5 A 7 A	250 AC 50 DC	145	118	200	•	•	•	•	•	•
755.150-S	5 A 7 A	250 AC 50 DC	150	123	200	•	•	•	•	•	•
755.205-S	5 A	125 AC 60 DC 250 AC	205	167	250	•	•	•		•	•
755.221-S	5 A	125 AC 60 DC	221	186	250	•	•	•		•	•

¹⁾ Toleranz / Tolerance: +0 / - 10 °C (IEC 60691)

Legende / Caption:

- I_N = Bemessungsstrom / Rated current
- U_N = Bemessungsspannung / Rated voltage
- T_N = Bemessungstemperatur / Rated functioning temp.
- T_H = Haltemperatur / Holding temperature
- T_{max} = max. Grenztemperatur / max. temp. limit

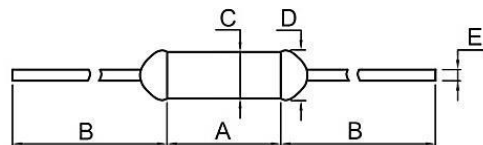

Dimensions (mm)

A	B	C (Φ)	D	E (Φ)
11.5 ± 0.5	35 ± 3	3.3 ± 0.5	≤ 3.8	0.8 ± 0.05

Temperatursicherungen 755.000-X Temperature-Fuses AC



Ø 3,6 x 11,5 mm



Spannung Voltage	250 V	Strom Current	5 A	Typ Type	Axial
----------------------------	--------------	-------------------------	------------	--------------------	--------------



Norm / Standard:	IEC 60691
Anschluss / Connection:	Rundstifte, Oberfläche verzinnt, steckbar und lötlbar / Round pins, Surface tin-plated, pluggable and solderable
Verpackungsmöglichkeiten / Packing options:	100 St. = lose geschüttet in Polybeutel / 100 pcs. = bulk in plastic bag

Bemessungswerte / Ratings:

Art. No.	I _N	U _N [V]	T _N ¹⁾ [°C]	T _H [°C]	T _{max} [°C]	UR	cUR	VDE	PSE	CCC	KC
755.084-X	5 A	250	84	65	200	●	●	●	●	●	●
755.102-X	5 A	250	102	80	200	●	●	●	●	●	●
755.115-X	5 A	250	115	99	200	●	●	●	●	●	●
755.125-X	5 A	250	125	105	200	●	●	●	●	●	●
755.130-X	5 A	250	130	107	200	●	●	●	●	●	●
755.135-X	5 A	250	135	115	200	●	●	●	●	●	●
755.138-X	5 A	250	138	118	200	●	●	●	●	●	●
755.145-X	5 A	250	145	126	200	●	●	●	●	●	●
755.150-X	5 A	250	150	128	200	●	●	●	●	●	●

¹⁾ Toleranz / Tolerance: +0 / - 10 °C (IEC 60691)

Legende / Caption:

- I_N = Bemessungsstrom / Rated current
- U_N = Bemessungsspannung / Rated voltage
- T_N = Bemessungstemperatur / Rated functioning temp.
- T_H = Haltetemperatur / Holding temperature
- T_{max} = max. Grenztemperatur / max. temp. limit

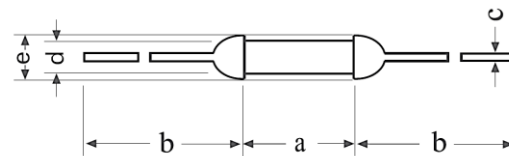

a	b	c	d	e
11,5 ± 0,5	38 ± 3	Ø0,6 ± 0,02	Ø3,3 ± 0,2	3,6 or below

Angaben / Dimension in [mm]

Ø 3,0 x 9,6 mm

G7-Series
 Version: lang-lang / long-long



Spannung
 Voltage **250 V / 24 V**

Strom
 Current **5 A**

Typ
 Type **Axial**



Norm / Standard:

IEC 60691

Anschluss / Connection:

Rundstifte (lang-lang),
 Oberfläche verzinnt, steckbar und lötlbar /
 Round pins (long-long),
 Surface tin-plated, pluggable and solderable

C: Verzinnetes Kupfer / Tin plated copper
 D: Versilbertes Kupfer / Silver plated copper

Verpackungsmöglichkeiten / Packing options:

2.000 St. = lose geschüttet in Polybeutel
 2.000 pcs. = bulk in plastic bag
 4.500 St. = auf Rolle gegurtet
 (= z.B.: 2.761.077) /
 4.500 pcs. = Taped and reeled
 (= e.g.: 2.761.077)

Bemessungswerte / Ratings:

Art. No.	T _N ¹⁾ [°C]	T _H [°C]	T _{max} [°C]
761.077	77	62	125
761.084	84	69	125
761.093	93	78	140
761.098	98	83	140
761.110	110	95	140
761.117	117	102	150
761.121	121	106	150
761.128	128	113	150
761.144	144	129	175
761.152	152	137	175
761.167	167	152	200
761.172	172	157	200
761.184	184	169	200
761.192	192	177	210

¹⁾ Toleranz / Tolerance: +0 / - 5 °C (IEC 60691)

I_N [A] / U_N [V]

UR / CSA		5 A / 250 V AC 5 A / 24 V DC
VDE		5 A / 250 V AC
CCC		5 A / 250 V AC 5 A / 24 V DC
PSE		5 A / 250 V AC
Korea		5 A / 250 V AC

Legende / Caption:

I_N = Bemessungsstrom / Rated current
 U_N = Bemessungsspannung / Rated voltage
 T_N = Bemessungstemperatur / Rated functioning temp.
 T_H = Haltetemperatur / Holding temperature
 T_{max} = max. Grenztemperatur / max. temp. limit

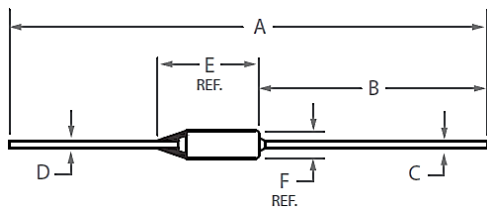

Maße / Dimensions:

A	Gesamtlänge / Overall length ± 3,0 mm	82,9 mm
B	Gehäuse-Pin Länge / Case lead length ±1,5 mm	34,9 mm
C	Durchmesser Leitung / Case lead diameter (Mit Gehäuse verbunden / Connected with case)	0,57 mm
D	Durchmesser Leitung / Case lead diameter (Isoliert von Gehäuse / Isolated from case)	0,57 mm
E · F	Gehäusemaße / Case dimensions	9,6 mm x 3,0 mm

Ø 4,0 x 14,7 mm

G4-Series
Version: kurz-lang / short-long



Spannung
Voltage **250 V / 24 V**

Strom
Current **5 A – 15 A**

Typ
Type **Axial**



Norm / Standard:

IEC 60691

Anschluss / Connection:

Rundstifte (kurz-lang),
Oberfläche verzinkt, steckbar und lötlbar /
Round pins (short-long),
Surface tin-plated, pluggable and solderable

C: Verzinktes Kupfer / Tin plated copper
D: Versilbertes Kupfer / Silver plated copper

(lang-lang-Version: ESKA 771.000) /
(long-long-version: ESKA 771.000)

Verpackungsmöglichkeiten / Packing options:

2.000 St. = lose geschüttet in Polybeutel
2.000 pcs. = bulk in plastic bag
4.500 St. = auf Rolle gegurtet
(= z.B.: 2.770.072) /
4.500 pcs. = Taped and reeled
(= e.g.: 2.770.072)

Bemessungswerte / Ratings:

Art. No.	T _N ¹⁾ [°C]	T _H [°C]	T _{max} [°C]
770.072	72	57	100
770.073	73	58	100
770.077	77	62	300
770.084	84	69	220
770.093	93	78	300
770.098	98	83	300
770.104	104	89	200
770.110	110	95	240
770.117	117	102	240
770.121	121	106	300
770.128	128	113	205
770.134	134	119	205
770.144	144	129	300
770.152	152	137	205
770.167	167	152	210
770.172	172	157	310
770.184	184	169	240
770.192	192	177	210
770.205	205	190	310
770.216	216	200	450
770.229	229	200	450
770.240	240	200	450
770.257	257	220	470

¹⁾ Toleranz / Tolerance: +0 / - 5 °C (IEC 60691)

		I _N [A] / U _N [V]
UR		10 A / 250 V AC
		15 A / 120 V DC
		21 A / 240 V AC
CSA		10 A / 250 V AC
		15 A / 120 V DC
		21 A / 240 V AC
VDE		5 A / 24 V DC
		10 A / 250 V AC
PSE		10 A / 250 V AC
CCC		10 A / 250 V AC
		5 A / 24 V DC
Korea		10 A / 250 V AC

Legende / Caption:

I_N = Bemessungsstrom / Rated current
U_N = Bemessungsspannung / Rated voltage
T_N = Bemessungstemperatur / Rated functioning temp.
T_H = Haltetemperatur / Holding temperature
T_{max} = max. Grenztemperatur / max. temp. limit

Maße / Dimensions:

A	Gesamtlänge / Overall length ± 3,0 mm	63,8 mm
B	Gehäuse-Pin Länge / Case lead length ± 1,5 mm	35,0 mm
C	Durchmesser Leitung / Case lead diameter (Mit Gehäuse verbunden / Connected with case)	1,0 mm
D	Durchmesser Leitung / Case lead diameter (Isoliert von Gehäuse / Isolated from case)	1,0 mm
E · F	Gehäusemaße / Case dimensions	14,7 mm x 4,0 mm

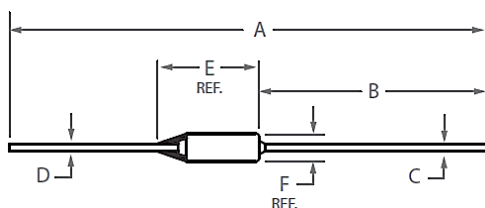

Ø 4,0 x 14,7 mm

G4-Series
Version: lang-lang / long-long



Spannung 250 V / 24 V
Voltage

Strom 5 A – 15 A
Current

Typ Axial
Type



Norm / Standard:

IEC 60691

Anschluss / Connection:

Rundstifte (lang-lang),
Oberfläche verzinnt, steckbar und lötlbar /
Round pins (long-long),
Surface tin-plated, pluggable and solderable

C: Verzinnertes Kupfer / Tin plated copper
D: Versilbertes Kupfer / Silver plated copper

(kurz-lang-Version: ESKA 770.000) /
(short-long-version: ESKA 770.000)

Verpackungsmöglichkeiten / Packing options:

2.000 St. = lose geschüttet in Polybeutel
2.000 pcs. = bulk in plastic bag
4.500 St. = auf Rolle gegurtet
(= z.B.: 2.771.072) /
4.500 pcs. = Taped and reeled
(= e.g.: 2.771.072)

Bemessungswerte / Ratings:

Art. No.	T _N ¹⁾ [°C]	T _H [°C]	T _{max} [°C]
771.072	72	57	100
771.073	73	58	100
771.077	77	62	300
771.084	84	69	220
771.093	93	78	300
771.098	98	83	300
771.104	104	89	200
771.110	110	95	240
771.117	117	102	240
771.121	121	106	300
771.128	128	113	205
771.134	134	119	205
771.144	144	129	300
771.152	152	137	205
771.167	167	152	210
771.172	172	157	310
771.184	184	169	240
771.192	192	177	210
771.205	205	190	310
771.216	216	200	450
771.229	229	200	450
771.240	240	200	450
771.257	257	220	470

¹⁾ Toleranz / Tolerance: +0 / - 5 °C (IEC 60691)

		I _N [A] / U _N [V]
UR		10 A / 250 V AC
		15 A / 120 V DC
		21 A / 240 V AC
CSA		10 A / 250 V AC
		15 A / 120 V DC
		21 A / 240 V AC
VDE		10 A / 250 V AC
PSE		10 A / 250 V AC
CCC		10 A / 250 V AC
		5 A / 24 V DC
Korea		10 A / 250 V AC

Legende / Caption:

I_N = Bemessungsstrom / Rated current
U_N = Bemessungsspannung / Rated voltage
T_N = Bemessungstemperatur / Rated functioning temp.
T_H = Haltetemperatur / Holding temperature
T_{max} = max. Grenztemperatur / max. temp. limit

Maße / Dimensions:

A	Gesamtlänge / Overall length ± 3,0 mm	84,7 mm
B	Gehäuse-Pin Länge / Case lead length ± 1,5 mm	35,0 mm
C	Durchmesser Leitung / Case lead diameter (Mit Gehäuse verbunden / Connected with case)	1,0 mm
D	Durchmesser Leitung / Case lead diameter (Isoliert von Gehäuse / Isolated from case)	1,0 mm
E · F	Gehäusemaße / Case dimensions	14,7 mm x 4,0 mm

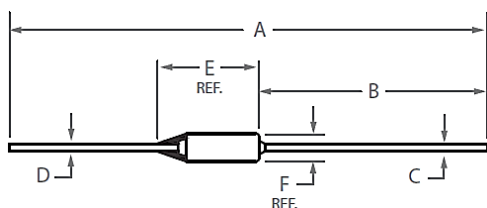

Temperatursicherungen 776.000 Temperature-Fuses AC



Ø 4,0 x 10,5 mm

Version: kurz-lang / short-long



Spannung Voltage	250 V / (125V)	Strom Current	10 A / (15A)	Typ Type	Axial
----------------------------	----------------	-------------------------	--------------	--------------------	-------



Spezifikation / Specification:

Anschluss / Connection:

Rundstifte (kurz-lang),
Oberfläche verzinkt, steckbar und lötfähig /
Round pins (short-long),
Surface tin-plated, pluggable and solderable

(lang-lang-Version: ESKA 777.000) /
(long-long-version: ESKA 777.000)

Max. Unterbrechungsstrom /
max. interrupting current

15 A @ 250V AC

Max. Transienter Überlastsstrom /
max. Transient overload current

3 ms @ 150 A DC

Verpackungsmöglichkeiten / Packing options:

500 St. = lose geschüttet in Polybeutel /
500 pcs. = bulk in plastic bag
4.500 St. = auf Rolle gegurtet /
4.500 pcs. = taped and reeled

Bemessungswerte / Ratings:

Art. No.	I _N	U _N [V]	T _N [°C]	T _H [°C]	T _{max} (VDE) [°C]	UR	cUR	VDE	TÜV	PSE	CCC	KC
776.072	10 A	250	72 (+2°C / -2°C)	57	200	●	●	●	●	●	●	●
776.077	10 A	250	77 (+0°C / -4°C)	62	200	●	●	●	●	●	●	●
776.084 ¹⁾	10 A	250	84 (+0°C / -5°C)	69	180	●	●	●	●	●	●	●
776.093 ¹⁾	10 A	250	93 (+0°C / -5°C)	78	180	●	●	●	●	●	●	●
776.098	10 A	250	98 (+2°C / -2°C)	83	190	●	●	●	●	●	●	●
776.110 ¹⁾	10 A	250	109 (+0°C / -5°C)	94	190	●	●	●	●	●	●	●
776.121 ¹⁾	10 A	250	121 (+0°C / -5°C)	106	200	●	●	●	●	●	●	●
776.128	10 A	250	128 (+0°C / -5°C)	113	200	●	●	●	●	●	●	●
776.144 ¹⁾	10 A	250	144 (+0°C / -5°C)	127	260	●	●	●	●	●	●	●
776.152	10 A	250	152 (+0°C / -4°C)	137	270	●	●	●	●	●	●	●
776.167	10 A	250	167 (+0°C / -4°C)	152	280	●	●	●	●	●	●	●
776.184	10 A	250	184 (+0°C / -6°C)	169	220	●	●	●	●	●	●	●
776.192	10 A	250	192 (+3°C / -3°C)	177	300	●	●	●	●	●	●	●
776.195	10 A	250	195 (+3°C / -6°C)	180	300	●	●	●	●	●	●	●
776.216 ¹⁾	10 A	250	216 (+0°C / -6°C)	200	370	●	●	●	●	●	●	●
776.222 ¹⁾	10 A	250	228 (+0°C / -6°C)	200	370	●	●	●	●	●	●	●
776.240 ¹⁾	10 A	250	240 (+0°C / -6°C)	200	370	●	●	●	●	●	●	●

¹⁾ Dual Ratings (UR approved): - 10A @ 250V and 15A @ 125V

Legende / Caption:

- I_N = Bemessungsstrom / Rated current
- U_N = Bemessungsspannung / Rated voltage
- T_N = Bemessungstemperatur / Rated functioning temp.
- T_H = Haltetemperatur / Holding temperature
- T_{max} = max. Grenztemperatur / max. temp. limit

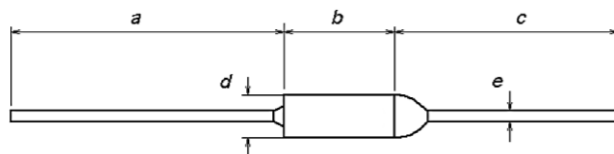

dimension(mm)	a	b	c	d	e
long	35.0 ±3.0	10.5 ±0.5	35.0 ±3.0	4.0 ±0.05	1.0
medium	22.0 ±3.0	10.5 ±0.5	25.0 ±3.0	4.0 ±0.05	1.0
short	35.0 ±3.0	10.5 ±0.5	18.0 ±3.0	4.0 ±0.05	1.0
special	65.0 ±1.0	10.5 ±0.5	40.0 ±1.0	4.0 ±0.05	1.0

Ø 4,0 x 10,5 mm

Version: lang-lang / long-long



Spannung Voltage	250 V / (125V)	Strom Current	10 A / (15A)	Typ Type	Axial
----------------------------	-----------------------	-------------------------	---------------------	--------------------	--------------



Spezifikation / Specification:

Anschluss / Connection:

Rundstifte (lang-lang),
 Oberfläche verzinnt, steckbar und lötfar /
 Round pins (long-long),
 Surface tin-plated, pluggable and solderable

(kurz-lang-Version: ESKA 776.000) /
 (short-lang-version: ESKA 776.000)

Max. Unterbrechungsstrom /
 max. interrupting current

15 A @ 250V AC

Max. Transienter Überlastsstrom /
 max. Transient overload current

3 ms @ 150 A DC

Verpackungsmöglichkeiten / Packing options:

500 St. = lose geschüttet in Polybeutel /
 500 pcs. = bulk in plastic bag
 4.500 St. = auf Rolle gegurtert /
 4.500 pcs. = taped and reeled

Bemessungswerte / Ratings:

Art. No.	I _N	U _N [V]	T _N [°C]	T _H [°C]	T _{max} (VDE) [°C]	UR	cUR	VDE	TÜV	PSE	CCC	KC
777.072	10 A	250	72 (+2°C / -2°C)	57	200	●	●	●	●	●	●	●
777.077	10 A	250	77 (+0°C / -4°C)	62	200	●	●	●	●	●	●	●
777.084 ¹⁾	10 A	250	84 (+0°C / -5°C)	69	180	●	●	●	●	●	●	●
777.093 ¹⁾	10 A	250	93 (+0°C / -5°C)	78	180	●	●	●	●	●	●	●
777.098	10 A	250	98 (+2°C / -2°C)	83	190	●	●	●	●	●	●	●
777.110 ¹⁾	10 A	250	109 (+0°C / -5°C)	94	190	●	●	●	●	●	●	●
777.121 ¹⁾	10 A	250	121 (+0°C / -5°C)	106	200	●	●	●	●	●	●	●
777.128	10 A	250	128 (+0°C / -5°C)	113	200	●	●	●	●	●	●	●
777.144 ¹⁾	10 A	250	144 (+0°C / -5°C)	127	260	●	●	●	●	●	●	●
777.152	10 A	250	152 (+0°C / -4°C)	137	270	●	●	●	●	●	●	●
777.167	10 A	250	167 (+0°C / -4°C)	152	280	●	●	●	●	●	●	●
777.184	10 A	250	184 (+0°C / -6°C)	169	220	●	●	●	●	●	●	●
777.192	10 A	250	192 (+3°C / -3°C)	177	300	●	●	●	●	●	●	●
777.195	10 A	250	195 (+3°C / -6°C)	180	300	●	●	●	●	●	●	●
777.216 ¹⁾	10 A	250	216 (+0°C / -6°C)	200	370	●	●	●	●	●	●	●
777.222 ¹⁾	10 A	250	228 (+0°C / -6°C)	200	370	●	●	●	●	●	●	●
777.240 ¹⁾	10 A	250	240 (+0°C / -6°C)	200	370	●	●	●	●	●	●	●

¹⁾ Dual Ratings (UR approved): - 10A @ 250V and 15A @ 125V

Legende / Caption:

- I_N = Bemessungsstrom / Rated current
- U_N = Bemessungsspannung / Rated voltage
- T_N = Bemessungstemperatur / Rated functioning temp.
- T_H = Haltetemperatur / Holding temperature
- T_{max} = max. Grenztemperatur / max. temp. limit

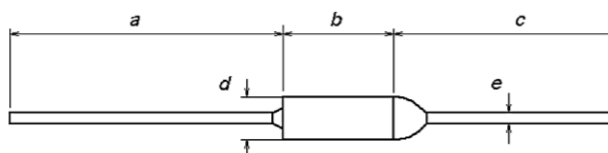

dimension(mm)	a	b	c	d	e
long	35.0 ±3.0	10.5 ±0.5	35.0 ±3.0	4.0 ±0.05	1.0
medium	22.0 ±3.0	10.5 ±0.5	25.0 ±3.0	4.0 ±0.05	1.0
short	35.0 ±3.0	10.5 ±0.5	18.0 ±3.0	4.0 ±0.05	1.0
special	65.0 ±1.0	10.5 ±0.5	40.0 ±1.0	4.0 ±0.05	1.0

Ø 4,2 x 10,5 mm

Version: kurz-lang / short-long



Spannung Voltage	250 V	Strom Current	20 A	Typ Type	Axial
----------------------------	--------------	-------------------------	-------------	--------------------	--------------



Spezifikation / Specification:

Anschluss / Connection:

Rundstifte (kurz-lang),
 Oberfläche verzinnt, steckbar und lötfar /
 Round pins (short-long),
 Surface tin-plated, pluggable and solderable

(lang-lang-Version: ESKA 779.000) /
 (long-long-version: ESKA 779.000)

Max. Unterbrechungsstrom /
 max. interrupting current

22,5 A @ 250V AC

Max. Transienter Überlastsstrom /
 max. Transient overload current

3 ms @ 300 A DC

Verpackungsmöglichkeiten / Packing options:

500 St. = lose geschüttet in Polybeutel /
 500 pcs. = bulk in plastic bag
 4.500 St. = auf Rolle gegurtert /
 4.500 pcs. = taped and reeled

Bemessungswerte / Ratings:

Art. No.	I _N	U _N [V]	T _N [°C]	T _H [°C]	T _{max} (VDE) [°C]	UR	cUR	VDE	TÜV	PSE	CCC	KC
778.072	20 A	250	72 (+2°C / -2°C)	47	120							●
778.077	20 A	250	77 (+0°C / -4°C)	52	120							●
778.084	20 A	250	84 (+0°C / -5°C)	59	150							●
778.093	20 A	250	93 (+0°C / -5°C)	68	220	●	●	●			●	●
778.098	20 A	250	98 (+0°C / -2°C)	73	220							●
778.109	20 A	250	109 (+0°C / -5°C)	94	190							●
778.121	20 A	250	121 (+0°C / -5°C)	96	230	●	●	●			●	●
778.128	20 A	250	128 (+0°C / -5°C)	103	270							●
778.144	20 A	250	144 (+0°C / -5°C)	119	290	●	●	●			●	●
778.152	20 A	250	152 (+0°C / -4°C)	127	290	●	●	●			●	●
778.167	20 A	250	167 (+0°C / -4°C)	142	290	●	●	●			●	●
778.184	20 A	250	184 (+0°C / -6°C)	159	300	●	●	●			●	●
778.195	20 A	250	195 (+0°C / -6°C)	170	300							●
778.216	20 A	250	216 (+0°C / -6°C)	200	370							●
778.228	20 A	250	228 (+0°C / -6°C)	200	370							●
778.240	20 A	250	240 (+0°C / -6°C)	200	370	●	●	●				●

Legende / Caption:

- I_N = Bemessungsstrom / Rated current
- U_N = Bemessungsspannung / Rated voltage
- T_N = Bemessungstemperatur / Rated functioning temp.
- T_H = Haltetemperatur / Holding temperature
- T_{max} = max. Grenztemperatur / max. temp. limit

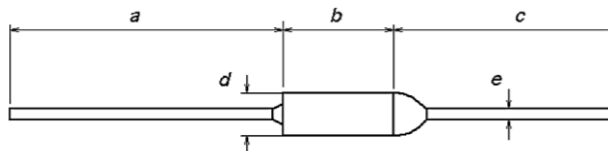

dimension(mm)	a	b	c	d	e
long	35.0 ±3.0	10.5 ±0.5	35.0 ±3.0	4.2 ±0.05	1.0
medium	22.0 ±3.0	10.5 ±0.5	25.0 ±3.0	4.2 ±0.05	1.0
short	18.0 ±3.0	10.5 ±0.5	20.0 ±3.0	4.2 ±0.05	1.0
special	65.0 ±1.0	10.5 ±0.5	40.0 ±1.0	4.2 ±0.05	1.0

Temperatursicherungen 779.000

Temperature-Fuses AC



Ø 4,2 x 10,5 mm

Version: lang-lang / long-long



Spannung Voltage	250 V	Strom Current	20 A	Typ Type	Axial
----------------------------	--------------	-------------------------	-------------	--------------------	--------------



Spezifikation / Specification:

Anschluss / Connection:

Rundstifte (lang-lang),
Oberfläche verzinnt, steckbar und lötfar /
Round pins (long-long),
Surface tin-plated, pluggable and solderable

(kurz-lang-Version: ESKA 778.000) /
(short-long-version: ESKA 778.000)

Max. Unterbrechungsstrom /
max. interrupting current

22,5 A @ 250 V AC

Max. Transienter Überlastsstrom /
max. Transient overload current

3 ms @ 300 A DC

Verpackungsmöglichkeiten / Packing options:

500 St. = lose geschüttet in Polybeutel /
500 pcs. = bulk in plastic bag
4.500 St. = auf Rolle gegurtert /
4.500 pcs. = taped and reeled

Bemessungswerte / Ratings:

Art. No.	I _N	U _N [V]	T _N [°C]	T _H [°C]	T _{max} (VDE) [°C]	UR	cUR	VDE	TÜV	PSE	CCC	KC
779.072	20 A	250	72 (+2°C / -2°C)	47	120							●
779.077	20 A	250	77 (+0°C / -4°C)	52	120							●
779.084	20 A	250	84 (+0°C / -5°C)	59	150							●
779.093	20 A	250	93 (+0°C / -5°C)	68	220	●	●	●			●	●
779.098	20 A	250	98 (+0°C / -2°C)	73	220							●
779.109	20 A	250	109 (+0°C / -5°C)	94	190							●
779.121	20 A	250	121 (+0°C / -5°C)	96	230	●	●	●			●	●
779.128	20 A	250	128 (+0°C / -5°C)	103	270							●
779.144	20 A	250	144 (+0°C / -5°C)	119	290	●	●	●			●	●
779.152	20 A	250	152 (+0°C / -4°C)	127	290	●	●	●			●	●
779.167	20 A	250	167 (+0°C / -4°C)	142	290	●	●	●			●	●
779.184	20 A	250	184 (+0°C / -6°C)	159	300	●	●	●			●	●
779.195	20 A	250	195 (+0°C / -6°C)	170	300							●
779.216	20 A	250	216 (+0°C / -6°C)	200	370							●
779.228	20 A	250	228 (+0°C / -6°C)	200	370							●
779.240	20 A	250	240 (+0°C / -6°C)	200	370	●	●	●				●

Legende / Caption:

- I_N = Bemessungsstrom / Rated current
- U_N = Bemessungsspannung / Rated voltage
- T_N = Bemessungstemperatur / Rated functioning temp.
- T_H = Haltetemperatur / Holding temperature
- T_{max} = max. Grenztemperatur / max. temp. limit

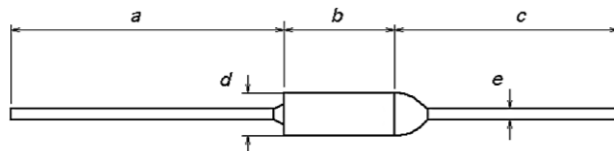

dimension(mm)	a	b	c	d	e
long	35.0 ±3.0	10.5 ±0.5	35.0 ±3.0	4.2 ±0.05	1.0
medium	22.0 ±3.0	10.5 ±0.5	25.0 ±3.0	4.2 ±0.05	1.0
short	18.0 ±3.0	10.5 ±0.5	20.0 ±3.0	4.2 ±0.05	1.0
special	65.0 ±1.0	10.5 ±0.5	40.0 ±1.0	4.2 ±0.05	1.0

Temperatursicherungen 780.000

Temperature-Fuses AC



Ø 4,0 x 14,7mm

G5-Series
Version: kurz-lang / short-long



Spannung Voltage	120 V / 240 V / 250 V / 277 V	Strom Current	15 A – 25 A	Typ Type	Axial
----------------------------	----------------------------------	-------------------------	-------------	--------------------	--------------



Norm / Standard:

IEC 60691

Anschluss / Connection:

Rundstifte (kurz-lang),
Oberfläche verzinnt, steckbar und lötlbar /
Round pins (short-long),
Surface tin-plated, pluggable and solderable

C: Verzinnertes Kupfer / Tin plated copper
D: Versilbertes Kupfer / Silver plated copper

(lang-lang-Version: ESKA 781.000) /
(long-long-version: ESKA 781.000)

Verpackungsmöglichkeiten / Packing options: 2.000 St. = lose geschüttet in Polybeutel
2.000 pcs. = bulk in plastic bag
4.500 St. = auf Rolle gegurtet
(= z.B.: 2.780.072) /
4.500 pcs. = Taped and reeled
(= e.g.: 2.780.072)

Bemessungswerte / Ratings:

Art. No.	T _N ¹⁾ [°C]	T _H [°C]	T _{max} [°C]
780.072	72	57	410
780.077	77	62	410
780.084	84	69	220
780.093	93	78	410
780.098	98	83	410
780.104	104	89	225
780.110	110	95	225
780.117	117	102	410
780.121	121	106	410
780.128	128	113	235
780.144	144	129	410
780.152	152	137	410
780.167	167	152	410
780.184	184	169	410
780.192	192	177	350
780.205	205	190	410
780.216	216	200	410
780.229	229	200	410
780.240	240	200	410

¹⁾ Toleranz / Tolerance: +0 / - 5 °C (IEC 60691)

	I _N [A] / U _N [V]
UR / CSA	20 A / 250 V AC
	20 A / 277 V AC
	21 A / 240 V AC
VDE	25 A / 120 V AC
	20 A / 250 V AC
CCC	20 A / 250 V AC
PSE	15 A / 250 V AC
Korea	16 A / 250 V AC

Legende / Caption:

I_N = Bemessungsstrom / Rated current
U_N = Bemessungsspannung / Rated voltage
T_N = Bemessungstemperatur / Rated functioning temp.
T_H = Haltetemperatur / Holding temperature
T_{max} = max. Grenztemperatur / max. temp. limit

Maße / Dimensions:

A	Gesamtlänge / Overall length ± 3,0 mm	63,8 mm
B	Gehäuse-Pin Länge / Case lead length ± 1,5 mm	35,0 mm
C	Durchmesser Leitung / Case lead diameter (Mit Gehäuse verbunden / Connected with case)	1,0 mm
D	Durchmesser Leitung / Case lead diameter (Isoliert von Gehäuse / Isolated from case)	1,0 mm
E · F	Gehäusemaße / Case dimensions	14,7 mm x 4,0 mm

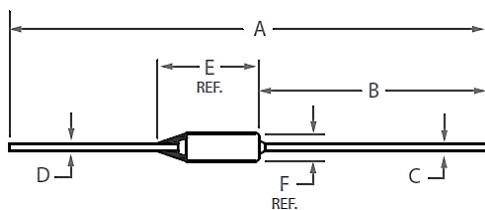

Temperatursicherungen 781.000

Temperature-Fuses AC



Ø 4,0 x 14,7mm

G5-Series
Version: lang-lang / long-long



Spannung Voltage	120 V / 240 V / 250 V / 277 V	Strom Current	15 A – 25 A	Typ Type	Axial
----------------------------	----------------------------------	-------------------------	-------------	--------------------	--------------



Norm / Standard:

IEC 60691

Anschluss / Connection:

Rundstifte (lang-lang),
Oberfläche verzinnt, steckbar und lötlbar /
Round pins (long-long),
Surface tin-plated, pluggable and solderable

C: Verzinntes Kupfer / Tin plated copper
D: Versilbertes Kupfer / Silver plated copper

(lang-lang-Version: ESKA 780.000) /
(long-long-version: ESKA 780.000)

Verpackungsmöglichkeiten / Packing options: 2.000 St. = lose geschüttet in Polybeutel
2.000 pcs. = bulk in plastic bag
4.500 St. = auf Rolle gegurtet
(= z.B.: 2.781.072) /
4.500 pcs. = Taped and reeled
(= e.g.: 2.781.072)

Bemessungswerte / Ratings:

Art. No.	T _N ¹⁾ [°C]	T _H [°C]	T _{max} [°C]
781.072	72	57	410
781.077	77	62	410
781.084	84	69	220
781.093	93	78	410
781.098	98	83	410
781.104	104	89	225
781.110	110	95	225
781.117	117	102	410
781.121	121	106	410
781.128	128	113	235
781.144	144	129	410
781.152	152	137	410
781.167	167	152	410
781.184	184	169	410
781.192	192	177	350
781.205	205	190	410
781.216	216	200	410
781.229	229	200	410
781.240	240	200	410

¹⁾ Toleranz / Tolerance: +0 / - 5 °C (IEC 60691)

	I _N [A] / U _N [V]
UR / CSA	20 A / 250 V AC
	20 A / 277 V AC
	21 A / 240 V AC
VDE	25 A / 120 V AC
	20 A / 250 V AC
CCC	20 A / 250 V AC
PSE	15 A / 250 V AC
Korea	16 A / 250 V AC

Legende / Caption:

I_N = Bemessungsstrom / Rated current
U_N = Bemessungsspannung / Rated voltage
T_N = Bemessungstemperatur / Rated functioning temp.
T_H = Haltetemperatur / Holding temperature
T_{max} = max. Grenztemperatur / max. temp. limit

Maße / Dimensions:

A	Gesamtlänge / Overall length ± 3,0 mm	84,7 mm
B	Gehäuse-Pin Länge / Case lead length ± 1,5 mm	35,0 mm
C	Durchmesser Leitung / Case lead diameter (Mit Gehäuse verbunden / Connected with case)	1,0 mm
D	Durchmesser Leitung / Case lead diameter (Isoliert von Gehäuse / Isolated from case)	1,0 mm
E · F	Gehäusemaße / Case dimensions	14,7 mm x 4,0 mm

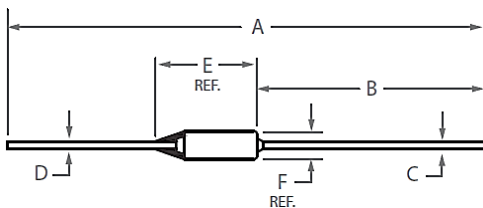

Temperatursicherungen 785.000

Temperature-Fuses AC

Ø 4,0 x 14,7mm

G8-Series
Version: lang-lang / long-long



Spannung Voltage	250 V / 277 V	Strom Current	20 A / 25 A	Typ Type	Axial
----------------------------	----------------------	-------------------------	--------------------	--------------------	--------------



Norm / Standard: IEC 60691

Anschluss / Connection: Rundstifte (lang-lang), Oberfläche verzinnt, steckbar und lötlbar / Round pins (long-long), Surface tin-plated, pluggable and solderable

C: Verzinnertes Kupfer / Tin plated copper
D: Versilbertes Kupfer / Silver plated copper

Verpackungsmöglichkeiten / Packing options: 2.000 St. = lose geschüttet in Polybeutel
2.000 pcs. = bulk in plastic bag
4.500 St. = auf Rolle gegurtet (= z.B.: 2.785.072) / 4.500 pcs. = Taped and reeled (= e.g.: 2.785.072)

Bemessungswerte / Ratings:

Art. No.	T _N ¹⁾ [°C]	T _H [°C]	T _{max} [°C]
785.072	72	47	410
785.077	77	62	410
785.084	84	69	220
785.093	93	78	410
785.098	98	83	410
785.104	104	89	225
785.110	110	95	225
785.117	117	102	410
785.121	121	106	410
785.128	128	113	235
785.144	144	119	410
785.167	167	152	410
785.184	184	169	410
785.192	192	177	350
785.229	229	200	410
785.240	240	200	410

¹⁾ Toleranz / Tolerance: +0 / - 5 °C (IEC 60691)

I _N [A] / U _N [V]	
UR / CSA	20 A / 277 V AC 25 A / 250 V DC
VDE	25 A / 250 V AC
CCC	25 A / 250 V AC
PSE	25 A / 250 V AC

Legende / Caption:

I_N = Bemessungsstrom / Rated current
U_N = Bemessungsspannung / Rated voltage
T_N = Bemessungstemperatur / Rated functioning temp.
T_H = Haltetemperatur / Holding temperature
T_{max} = max. Grenztemperatur / max. temp. limit

Maße / Dimensions:

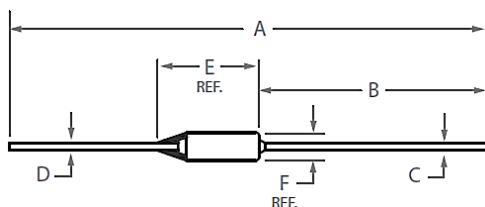

A	Gesamtlänge / Overall length ± 3,0 mm	84,7 mm
B	Gehäuse-Pin Länge / Case lead length ±1,5 mm	35,0 mm
C	Durchmesser Leitung / Case lead diameter	1,0 mm
D	Durchmesser Leitung / Case lead diameter (Isoliert von Gehäuse / Isolated from case)	1,0 mm
E · F	Gehäusemaße / Case dimensions	14,7 mm x 4,0 mm