

# HUMAN CENTRIC LIGHTING BIOLUX

Installation  
Q&A

A group of diverse business professionals are seated around a table in a modern office setting, engaged in a meeting. A woman in the center is smiling and gesturing while speaking. The background shows a blurred office environment with other people working.

# INSTALLATION

## Content of Packaging

### BIOLUX HCL CONTROL UNIT

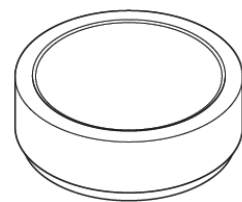

control unit /  
steering wheel



control unit insert

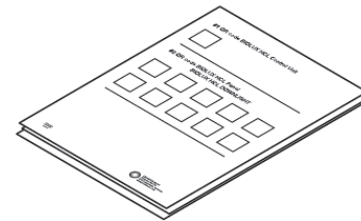

documentation paper  
- User Instruction  
- QR code leaflet

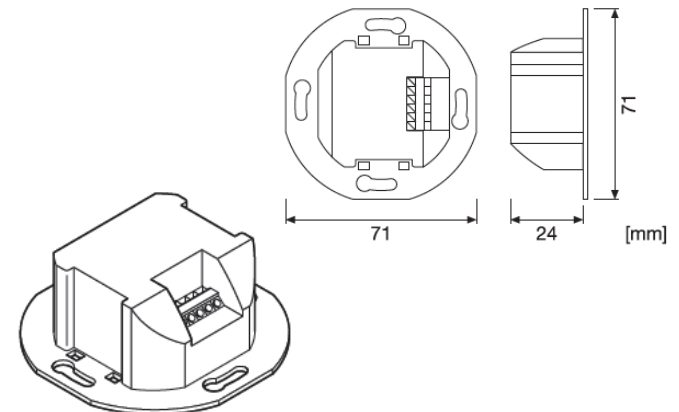

# INSTALLATION

## BIOLUX HCL CONTROL UNIT



### Required for the installation

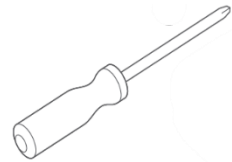

screwdriver



smart device

standard flush-mounted box  
(60mm) which is typical  
used for light switches

power cable for  
connection from  
light switch to  
control unit

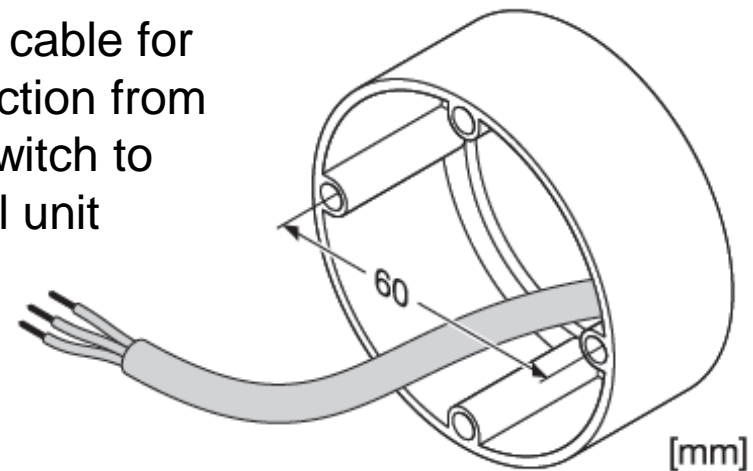

# INSTALLATION

## BIOLUX HCL CONTROL UNIT



## Preparation for the wireless Connection between HCL Control Unit and HCL Luminaires

Take QR code from BIOLUX HCL Control Unit and stick it on the QR code leaflet.

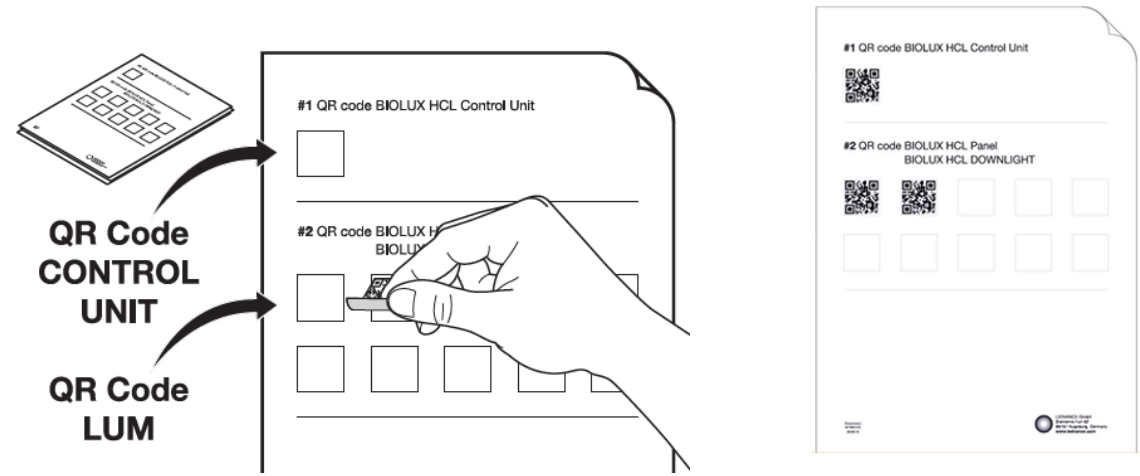
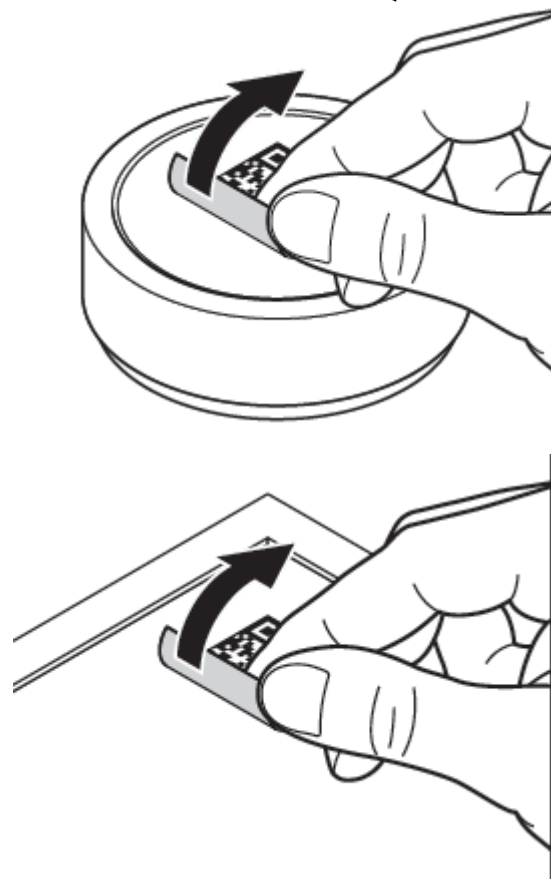

The QR code leaflet is for the later connection between the HCL Control Unit and HCL Luminaire required.

# INSTALLATION

## BIOLUX HCL LUMINAIRES



## HCL Luminaire installation

Make sure you turn mains  
of before installation

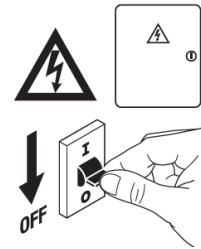

### BIOLUX HCL Panel

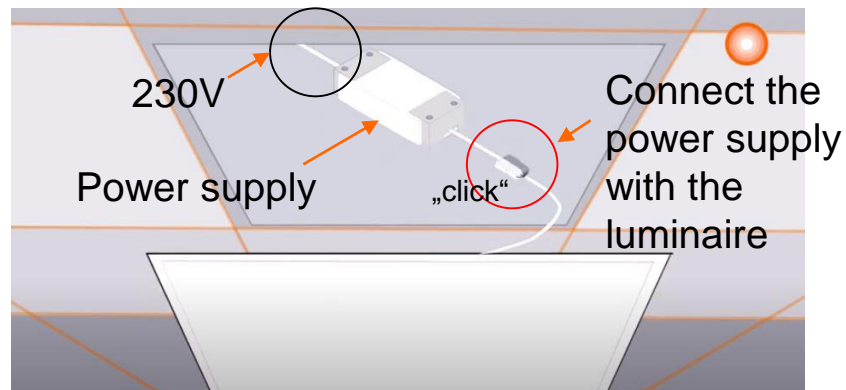

### BIOLUX HCL Downlight

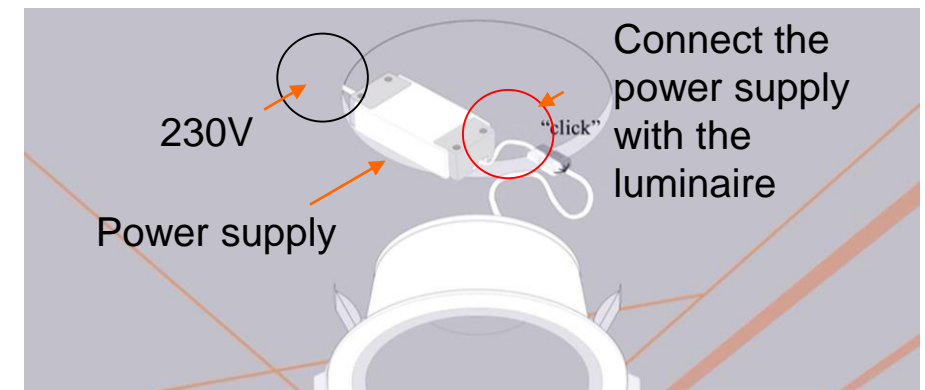

1. Connect the HCL luminaire power supply with 230V
2. Connect / "Click" the power supply with the luminaire
3. Put the luminaire in the ceiling

# INSTALLATION

## BIOLUX HCL CONTROL UNIT



## Installation of flush mounting box

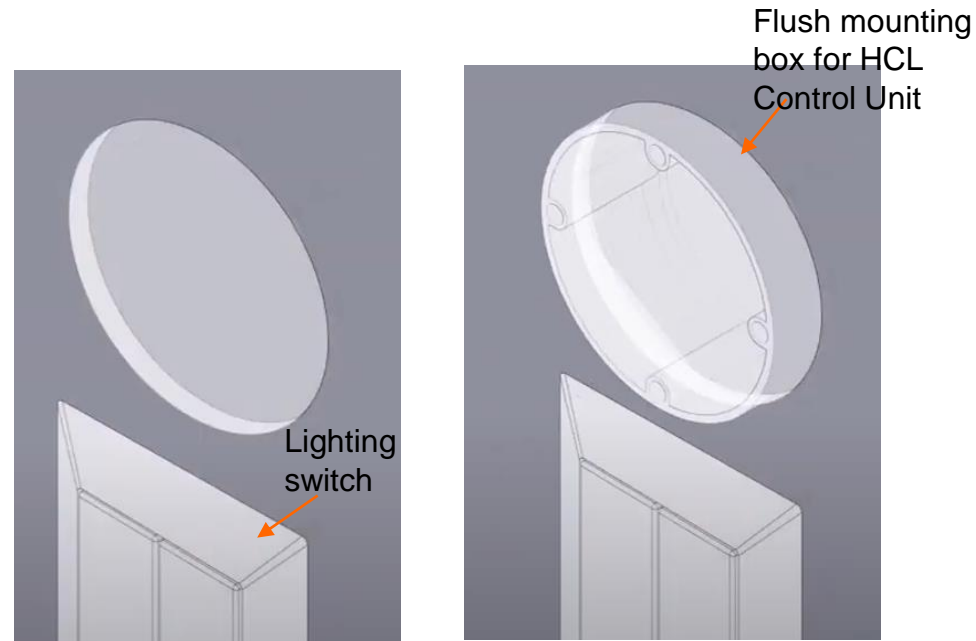

Fixing of the flush-mounted box above of the lighting switch.

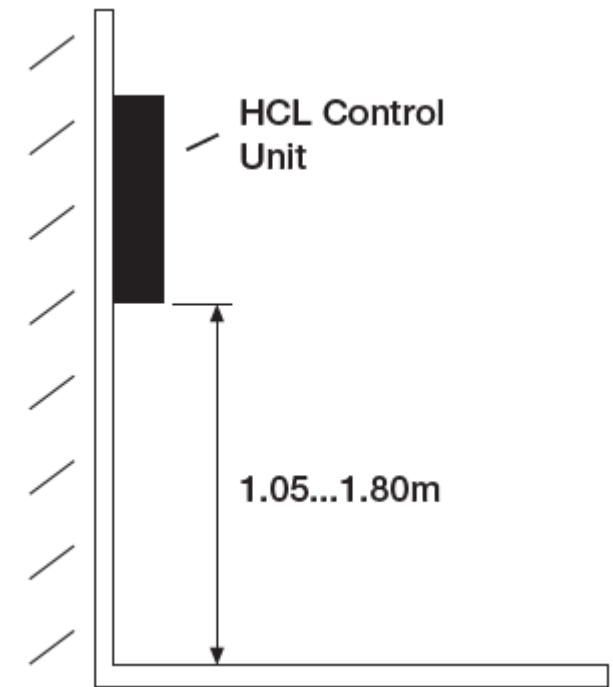

For ergonomical reasons installation height should be between 1.05 and 1.80 m

# INSTALLATION

## BIOLUX HCL CONTROL UNIT



### Hint

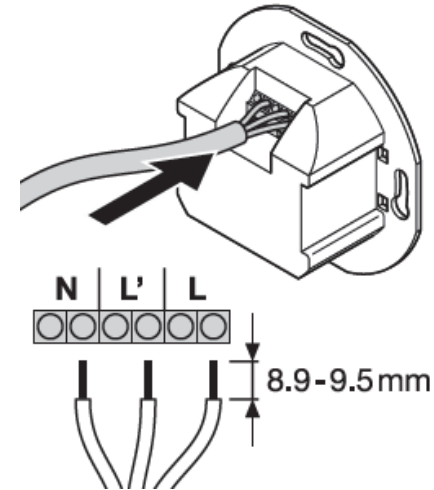

The light switch is still used to turn lighting on and off.

The control unit needs to be electrical connected to the light switch.  
See next slide.

# INSTALLATION

## BIOLUX HCL CONTROL UNIT



### Wiring diagram

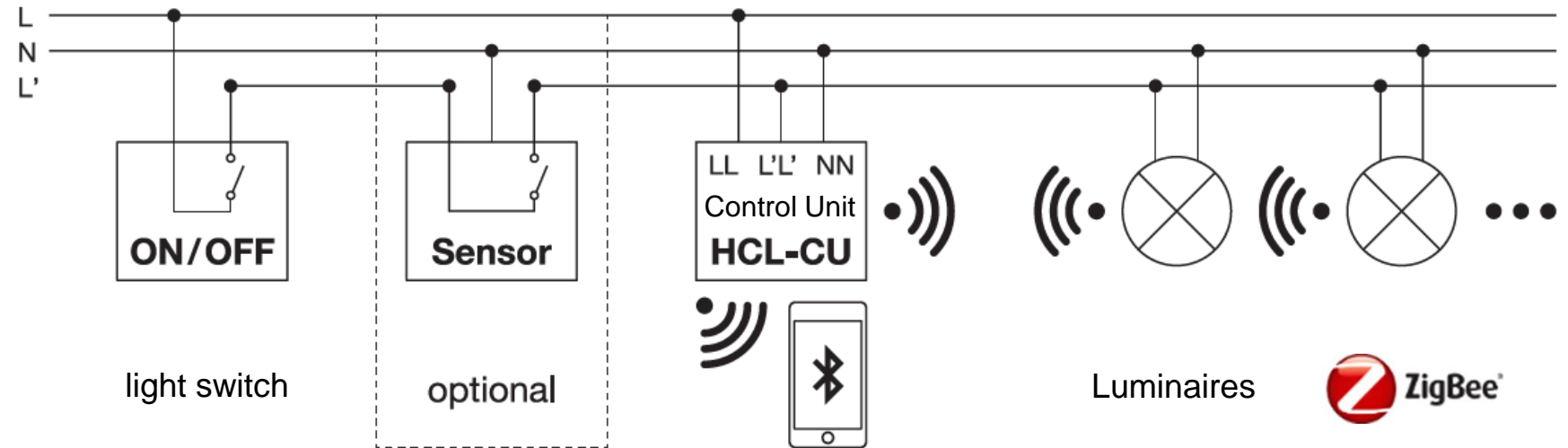

The connection of the HCL Luminares with HCL Control Unit happens with the LEDVANCE BIOLUX APP – see page 12 for further information



# INSTALLATION

## Installation of HCL Control Unit in flush-mount box

### BIOLUX HCL Control unit



1. Electrical connection of HCL Control Unit with the light switch – see page 21, wiring diagram

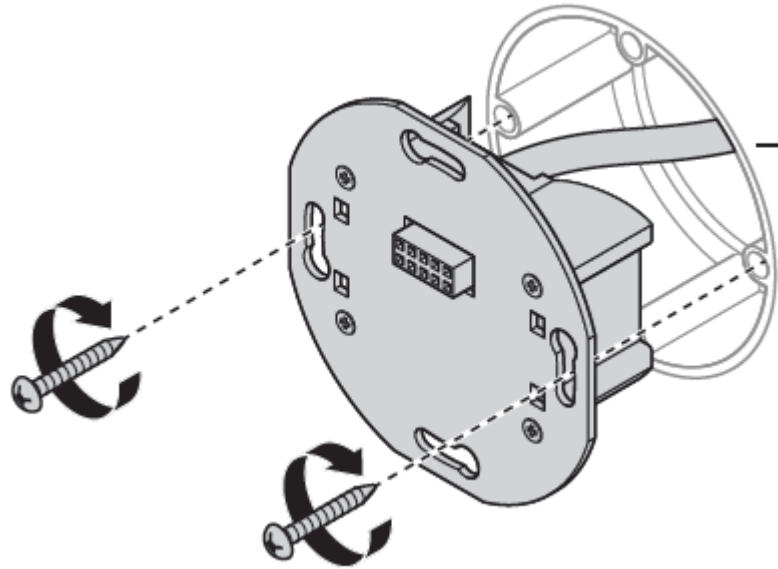

2. Fix BIOLUX HCL Control Unit in flush-mount box

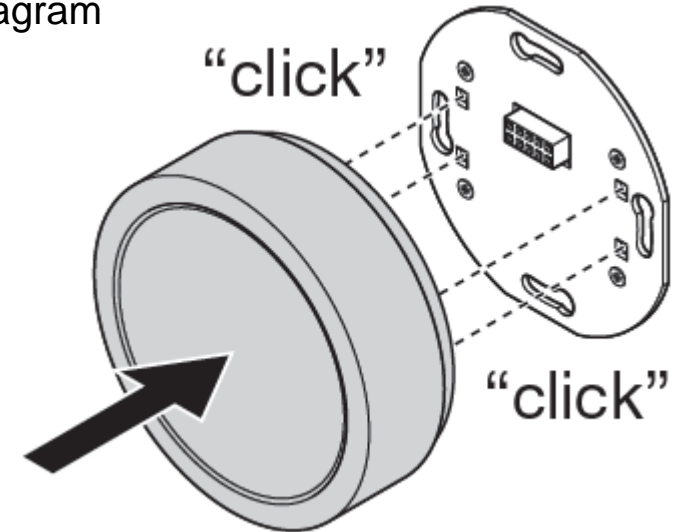

3. Click in BIOLUX HCL Control steering unit

# INSTALLATION

## BIOLUX HCL CONTROL UNIT



### Hint

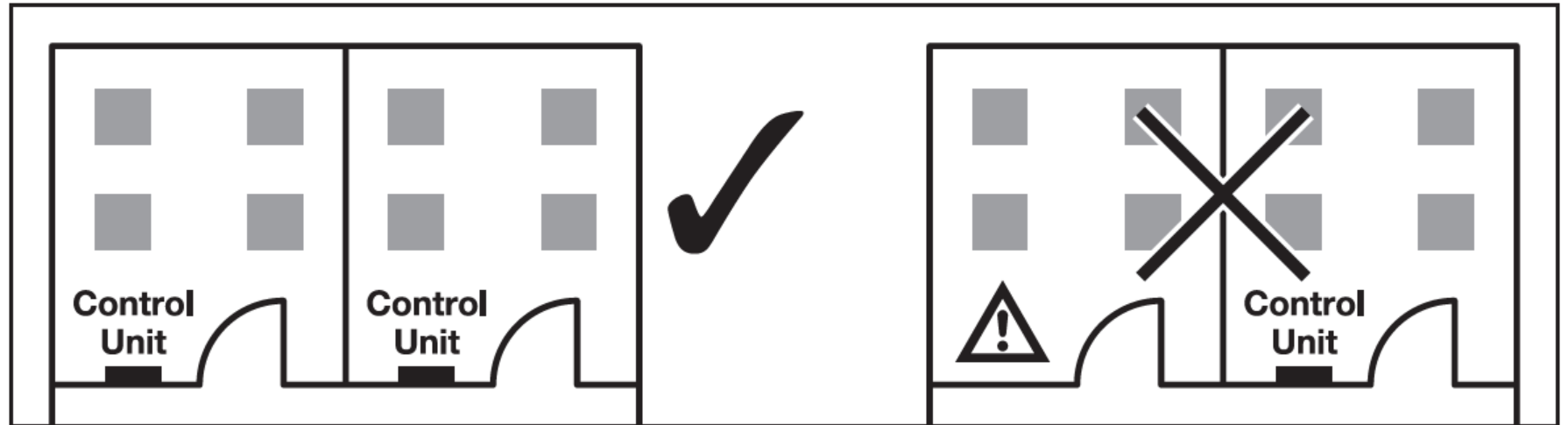

One Control Unit for luminaires in one room

# INSTALLATION

## BIOLUX HCL Control unit



### Hint

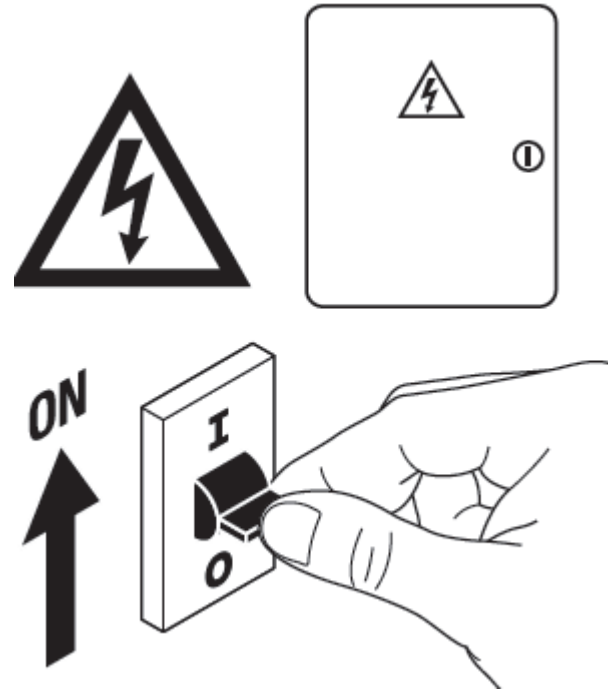

Turn power back on

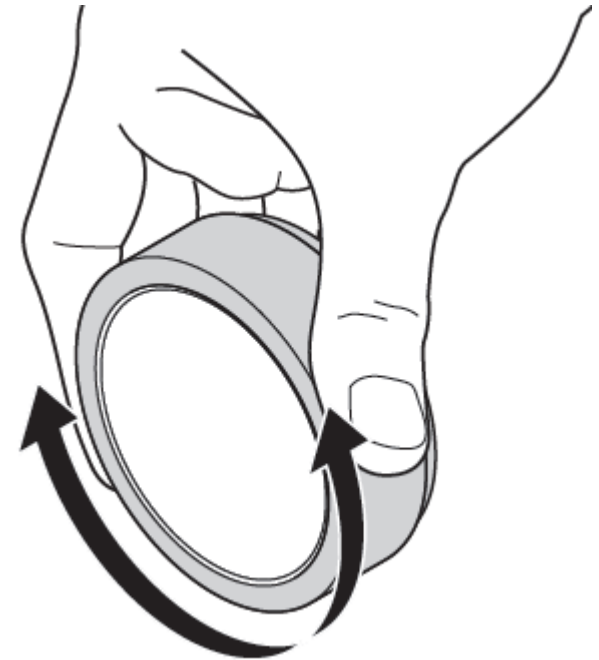

Installation of HCL System is finished now

## SET UP

### Connection of installed HCL Luminaires with the HCL Control Unit with the BIOLUX App

via BIOLUX app



**The purpose of the App is to connect the HCL Luminaires with the HCL Control Unit**

1. Download the BIOLUX APP on your Smartphone or Tablett
2. Start the App



# SET UP

via BIOLUX app

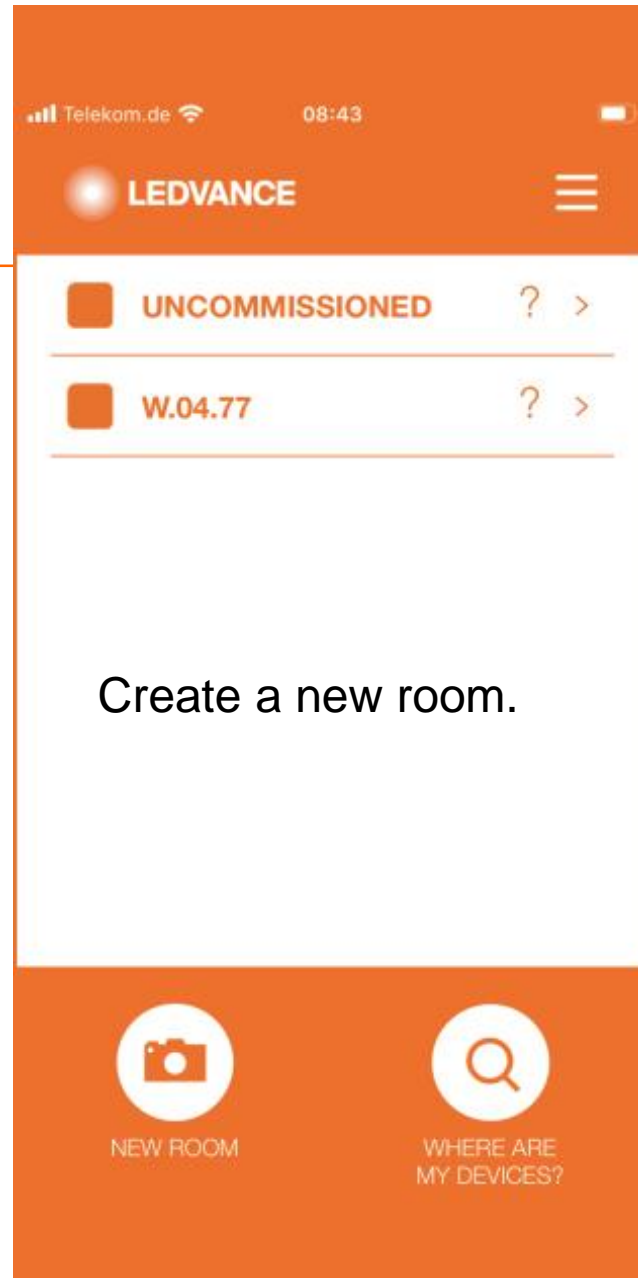

Create a new room.

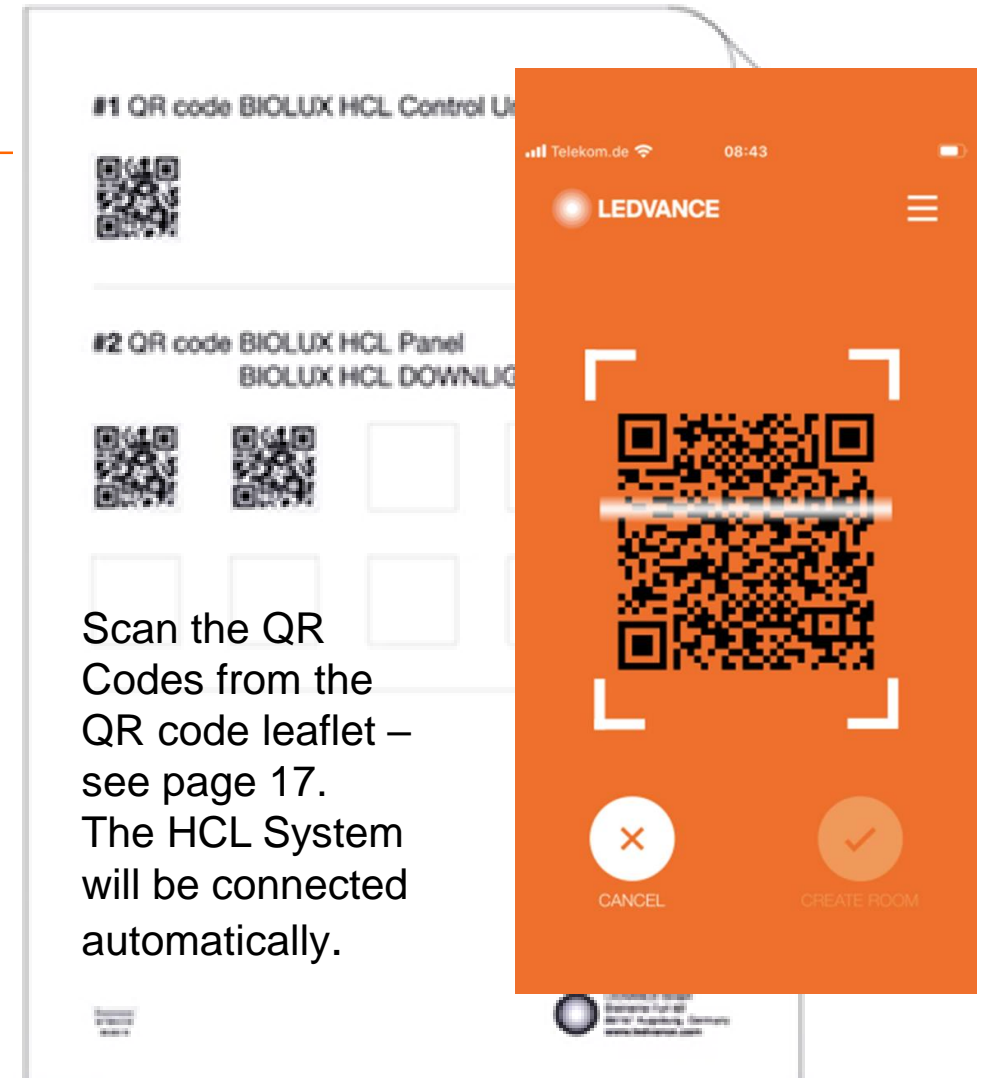

Scan the QR Codes from the QR code leaflet – see page 17. The HCL System will be connected automatically.

# SET UP

via BIOLUX app

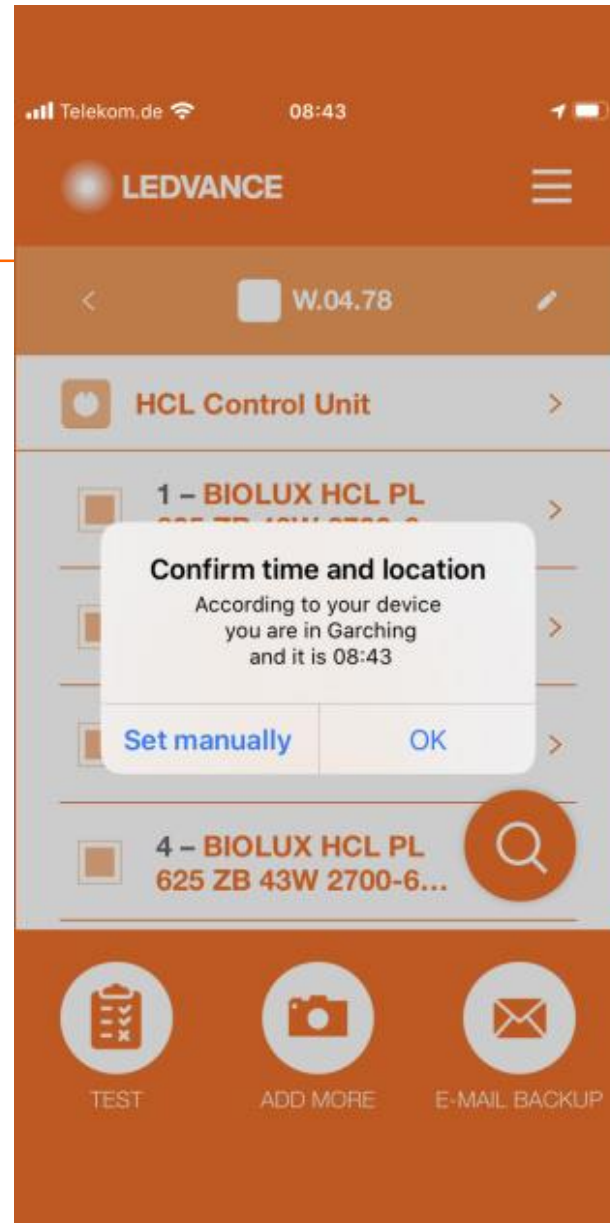

No manual programming required:

**Location and time is automatically detected via BIOLUX HCL app.**

Artificially light will change according to natural light at the place it is installed.

# SET UP

via BIOLUX app



## Hint



The system creates a ZigBee network between the installed HCL products.

When all luminaires are flashing, system is ready. The HCL system is now completely installed and ready to use.

# SET UP

easy via  
BIOLUX  
smartphone  
app

## Hint

Commissioning process to connect the HCL products has to be finalized within one hour.

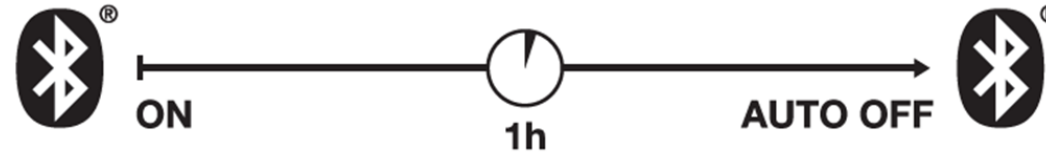

Reset of control unit: Turn control unit in following order:

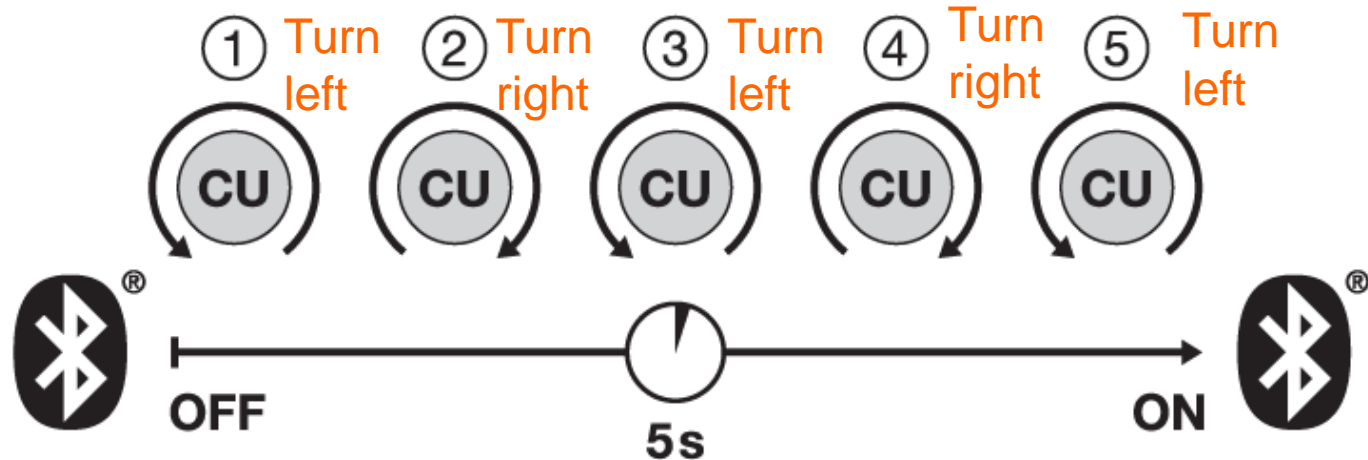



---

# Q&A

## Q&A

---

### How can I do the commissioning / initial configuration of my BIOLUX system?

The wiring and installation of the luminaires and the HCL Control Unit needs to be done by a qualified electrician. The peelable QR-codes of each BIOLUX HCL device need to be collected on the leaflet of the Control Unit. Write the name of the room to the leaflet!

After the electrical installation, you need the HCL BIOLUX app for commissioning of the luminaires. Just simply select the “New Room”, scan the QR-codes 1 by 1 and when you finished, give a name to the room. The app tries to detect where is the installation and what is the exact time. If the detected values are right, just simply accept them. If the Control Unit is in Bluetooth® LE range, the configuration data will be automatically up-loaded and the commissioning of the wireless network starts.

The process is fully automated from this point and does not require any human interaction. A kind of radar icon will be visible on the display of the Control Unit. As soon as the process has been finished, the Control Unit changes to NATURAL mode and the lights will change their intensity and color temperature according to the right setting.

Important precondition: All new devices shall be powered and shall be in factory reset status!

### What is the content of the QR-codes on the devices?

The QR-code contains the type, manufacturer code, the MAC addresses and the secret installation code of the device. This code is needed for setting up secure connection between the devices. This QR-code is known only by the installer or owner of the system. Please do not share it with anyone else.

The QR-code is unique for each single luminaire driver and cannot be used for any other luminaire driver, also not the same type.

## Q&A

---

### **Can I control the lights of other manufacturers with the CU?**

No. Only luminaires of the LEDVANCE BIOLUX series can be used. Luminaires from other manufacturers as well as other LEDVANCE luminaires than the BIOLUX series cannot be used.

### **Can I integrate the lights in the controls of other manufacturers? If so, which one?**

The luminaires themselves - without connection to the HCL CU - can be integrated into any Zigbee system like other Zigbee luminaires. The HCL functionality of the LEDVANCE HCL Control Unit will not be possible in this case. The user is responsible for a suitable control of the luminaires himself. If the lights are connected to the HCL-CU, they can not be integrated into a second controller. Then it is only possible to switch the lights on and off by disconnecting the power supply, similar to the presence sensor.

### **How I can check if the devices are in factory reset mode?**

If the luminaires are in factory reset mode, they are playing a blinky pattern with cold white, warm white, cold white and ending with 4000 K after each power up. Luminaires in factory reset mode cannot be controlled and will always show 100% light output at 4000 K after the blinking sequence described above. The Control Unit is in factory reset mode if its room name in the HCL BIOLUX app is “UNCOMMISSIONED”.

### **How I can do factory reset of the luminaires?**

Follow a special power-on / off sequence: power-on, wait 5s, power-off, wait 5s – and repeat it 5 times. After this procedure the luminaires will play the blinky pattern with cold white, warm white, cold white and ending with 4000 K after each power up.

## Q&A

---

### **Can I use more than one CU in the room or connect it to the lights?**

For each CU, the commissioning process determines which lights are connected to it and thus which lights are controlled by the CU.

Each luminaire can only be connected to one CU.

If you install several CUs and connect different luminaires in one room, each with a CU, the room is treated as if it were several separate rooms each with a single CU.

For example, a large meeting room, which is separated in the middle would require two CUs.

Currently it is not possible to control two groups of luminaires with a single CU.

It is also not possible to connect the same luminaires to several CUs, so that all luminaires in a room can be controlled by one or the other CU.

### **Is it possible to combine the system with a presence sensor?**

Yes. The sensor switches the lights on or off. The sensor is connected in series with the power supply of the luminaires and switches the luminaires on and off. The switched signal must be given to the L' connection of the CU.

Any external presence detector can be used to switch on the power for the luminaires. The L' connection does not have a switching function.

It is only needed as a signal to the CU to indicate the status of the luminaires.

Zigbee sensors or other sensors that give only one control signal can not be used.

## Q&A

---

### **How can I do a factory reset of the Control Unit?**

Select it in the HCL BIOLUX app, go to the HCL Control Unit and use the “Factory reset menu”. If the luminaires are in range and in the low-power radio network, the Control Unit setting them also automatically to factory reset mode.

### **What handheld device I can use for the configuration?**

The HCL BIOLUX application is available for Android® and iOS® operating systems. The app needs to know the location of the installation for the accurate astronomic calculations, therefore only GPS enabled devices can be used, eg. some iPads are not supported. Devices without GPS system may support to enter the location manually.

### **Can I configure the system without the HCL BIOLUX application on a mobile device?**

No.

### **Can I do the configuration before the installation?**

Yes, the on-site paper work can be avoided. The HCL BIOLUX app is able to read the QR-code contents and save the settings with a given room name. After the physical installation of the devices, the application can connect to the Control Unit and upload the configuration.

## Q&A

---

### **Is a username and password required? How can I register?**

You do not need to register at all. If you have physical access to the QR-codes of the luminaires and the Control Unit, you can do initial set-up or maintenance.

### **Does the BIOLUX app or the Control Unit share any data to LEDVANCE or any other third party?**

No, the HCL BIOLUX app is only communicating to the HCL Control Unit to do the setup. The time and the geographic location is not shared outside the system of HCL BIOLUX app and HCL Control Unit. Communication includes the following data:

- check on the LEDVANCE server if a software update for the CU or for the luminaires is available. Only version numbers of the software and the products is required for this. Data will not be stored on any system. If accepted the updates will be downloaded by the mobile phone and transferred to the Control Unit. This function will only be initiated if internet connection is established on the mobile phone.
- time and geographic location is transferred from the mobile phone to the BIOLUX app and saved to the Control Unit, if allowed in the settings of the mobile phone. Otherwise the user has the option to add the location manually. The geographic location received by the mobile device is rounded by the BIOLUX app to two digits, corresponding to a range of some miles to avoid exact determination of the location. It still allows calculation of the time of sunrise and sunset with an accuracy better than 2 minutes.
- if the user decides to send a backup by email it is in his own responsibility to keep this email and the content safe. Data will only be sent to the addresses entered by the user. The BIOLUX app does not use an own emailing system, but is only creating a draft for an email in the user's email system, which can be sent by the user.

## Q&A

---

### **Can I commission the system to a different place?**

As long as this different place is in the same time zone, it is easy to select the location manually by not confirming the automatically detected location and select a different place on the map which will be shown.

If the different place is in a different time zone the correct time and timezone for this place has to be set up in the settings of the mobile phone before and automated setting of time and time zone disabled, which requires some expertise.

The user is responsible not to misuse this feature to set the system to inappropriate time settings.

### **How can I add a new luminaire to an existing system?**

If you are on-site, just click to the name of the room and use the “Add more” menu. Scan the QR-code of the luminaire(s) and after you finished the Control Unit starts to join them to the network.

Important precondition: All device shall be powered and all device shall be in factory reset state!

### **How can I replace a luminaire in an existing system?**

If you are on-site, select the replaceable luminaire in the list, click to its name and use the “Delete” menu. The Control Unit will remove it from the network and reset the luminaire to factory reset mode. As a next step, use the “Add more” menu with the new luminaire.

## Q&A

---

### **I have 20 pcs same type luminaires in the system, how I can find which one is the replaceable one?**

Use the magnifier menu in the application and scan the QR-code of the this luminaire (you can find it either on the leaflet, or on the back side of the luminaire or on the driver of the luminaire. Both are the same!)

How can I replace the Control Unit in an existing system?

If you are on-site, select the room name in the application and the HCL Control Unit in the list. Use the “Replace” feature in the menu. You need another Control Unit also!

### **The luminaires do not connect to the Control Unit during the commissioning process. What should I do?**

Please check if the luminaires are really in factory reset mode. If not, please reset them.

### **The luminaires are almost immediately blinking one after I powered-on them, but not joining later to the Control Unit. What should I do?**

The luminaires are joining to a different open low-power network in the neighborhood. Please find out, where is it and ask its owner to close the permit join window because it bothers other systems in the building.

The BIOLUX Control Unit enables to join only the already scanned (QR-code) luminaires and does not “steal” the control of not intended devices. You need to reset those luminaires which have joined to a different system to factory reset mode before trying to recommission them.



## Q&A

---

### **How can I do the factory reset of a luminaire?**

If the luminaire is commissioned to a BIOLUX Control Unit, delete it from the list shown in the HCL BIOLUX app.

If the luminaire cannot be addressed by the BIOLUX app, you need to do a hard reset. Do a cycle of five times power on and power off for five seconds each. Luminaires which are reset are blinking in a pattern of cold white - warm white – cold white – 4000 K after power on.

### **Can I use a presence sensor together with the system?**

Yes. You can use a sensor that can cut the line power of the luminaires.

Important: during the commissioning of the luminaires, please avoid their power cut!

Presence sensors which send control signals, but do not cut the power line to the luminaires cannot be used.

### **Can I use Daylight Harvesting with the BIOLUX HCL system?**

No. This system is designed to rooms where there is not enough daylight. DH and HCL together is often not adequate. Integration of a daylight sensor will be a future feature which may be provided by a software update at a given time.

### **How can I add a new luminaire to an existing system?**

If you are on-site, just click to the name of the room and use the “Add more” menu. Scan the QR-code of the luminaire(s) and after you finished the Control Unit starts to join them to the network.

Important precondition: All new devices shall be powered and shall be in factory reset mode!

## Q&A

---

### **How can I exchange the HCL Control Unit if it is not functional?**

Select the room and the Control Unit to be replaced and click „Replace“.

If a connection from the HCL BIOLUX app to the Control Unit can still be established, confirm by pressing the second „Replace“, Scan the QR-code of the replacement CU, and press „Replace“ again. The old Control Unit and the luminaires will be reset, the configuration will be transferred to the new one and the luminaires will be commissioned to the new CU automatically.

If the old CU cannot be connected any more, you still can connect a new CU. But as the luminaires are still commissioned to the old CU, the luminaires need to be reset to factory mode manually before (see related Q&A). In the HCL BIOLUX app select the room and the old CU and click on „Replace“. The configuration will be transferred to the new CU and if the luminaires are in factory reset mode, they will be commissioned to the new CU.

### **Can I work together with my colleagues on the installation and the later maintenance?**

The configuration can be exported and sent by e-mail to the colleagues. The HCL BIOLUX app can read the special e-mail attachment and import into its own database.

This export is also suitable for configuration backup. The settings can be recovered if the e-mail is available.

To do this select the \*.ldv-file in the email program on the mobile phone where the BIOLUX app is installed and share it to the BIOLUX app. Then click „Import“ in the BIOLUX app.

## Q&A

---

### **Can I change the intensity level or the Color Temperature of the luminaires with the HCL BIOLUX application?**

The application cannot be used as a remote control. The application is not intended to change the dim level or the color temperature directly, as the user also cannot do it directly with the Control Unit. The user can select operating mode like RELAX or NATURAL or BOOST and the Control Unit calculates the relevant intensity and color temperature values, according to the geo-location and the date&time.

The goal of this system to provide the right light at the right time and to prevent inadequate stimulation of the biological system at the wrong time. Manual adjustment of the intensity or color temperature could compromise this behavior.

### **How can I do the later maintenance if I lost my mobile phone or if it has been seriously damaged?**

There are two options.

- a. if the configuration was exported by e-mail just simple send back the e-mail to the new phone and open the attached \*.ldv-file. The settings will be automatically imported.
- b. go onsite. Try to connect to the Control Unit with the HCL BIOLUX app. It will ask to scan the QR-code of the Control Unit.
  - use the existing leaflet, which was stored at a safe place after installation or
  - remove the outer-side of the Control Unit from the in-wall part, scan, put back the Control Unit to its place and the app can automatically download the settings of the whole system

## Q&A

---

### **How can I add a new luminaire to an existing system?**

If you are on-site, just click to the name of the room and use the “Add more” menu. Scan the QR-code of the new luminaire(s) and after you finished the Control Unit will start to join them to the network.

Important precondition: All new luminaires shall be powered and all new devices shall be in factory reset state before starting the joining process!

### **I cannot see the operating mode on the display of the Control Unit, but I can see 3 quickly changing circles. What should I do?**

The Control Unit has detected some sort of error condition. Like loss of the time settings after a long power cut. The HCL BIOLUX app can correct the time settings automatically after the connection has been established.

### **I can see just a white point at the center of the Control Unit? What should I do?**

The luminaires have no line power because the wall-switch is in OFF state or the L' pin of the Control Unit has not been wired well. Switch on the luminaires with the wall-switch. If it does not help, call a service person to check correct wiring.

## Q&A

---

### **After the power-on of the luminaires, they are not reacting immediately to the operating mode change. What should I do?**

These luminaires originally designed to having continuous power. They need some time after the power-on to establish their low-power wireless connection again. Depends on the size of the network, it takes up to 15s. Wait a bit and then select the desired mode.

### **I am frequently installing HCL BIOLUX systems. How does the app help me to organize different projects?**

The app automatically puts to the top of the list the rooms which are in Bluetooth® range. The most recent installations are also on the top section of the list. The older installations are automatically moved to the “Archived Rooms” section. If you do not need one configuration, you can delete it, either with left swipe gesture or in the room name per HCL Control Unit page under “Factory reset” with the “Delete” option.