



INSTRUCTION

SRGVU/1500 - ...

1901 550

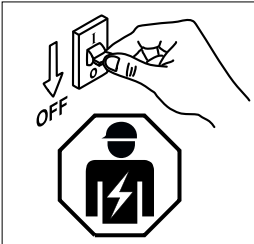

REGIOLUX

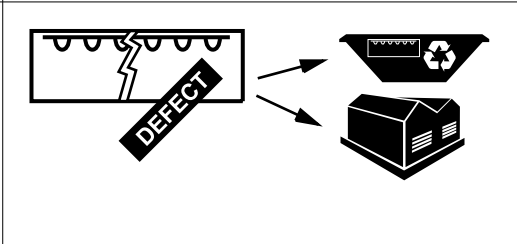
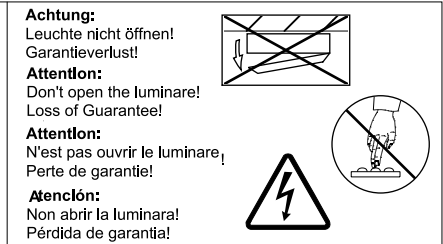
Regiolux GmbH
 Hellinger Str. 3
 D-97486 Königsberg/Bay.
 Telefon (0 95 25) 89-0
 Telefax (0 95 25) 89 73 4
<http://www.regiolux.de>
 e-Mail: info@regiolux.de

			<p>Achtung: Leuchte nicht öffnen! Garantieverlust!</p> <p>Attention: Don't open the luminaire! Loss of Guarantee!</p> <p>Atención: N'est pas ouvrir le luminaire, Perte de garantie!</p> <p>Atención: Non abrir la luminara! Pérdida de garantía!</p> 
---	---	--	---

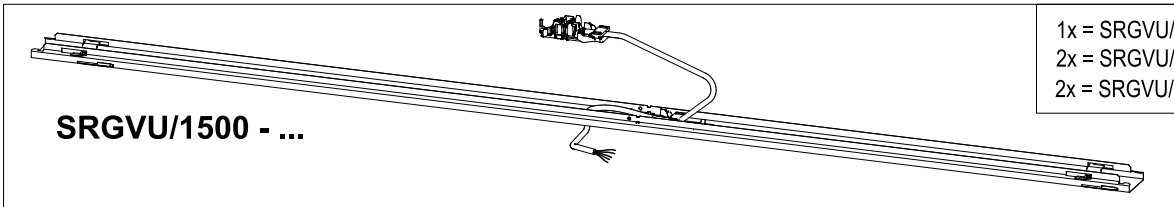
SRGVU/1500 - ...



1x = SRGVU/1500-130	
2x = SRGVU/1500-240	
2x = SRGVU/1500-355	
-130	-240/-355
 2x	 2x

+SRT (192.)

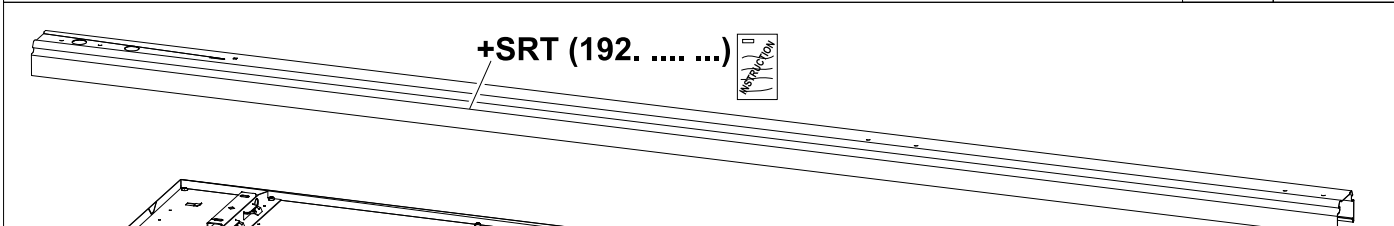

+alevo AVA (6571)

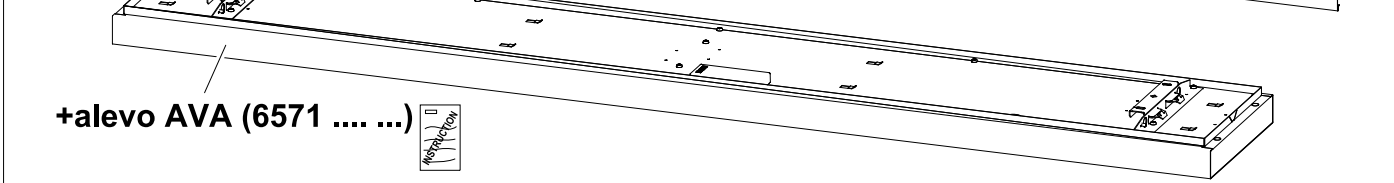

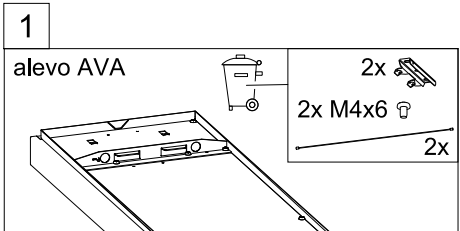
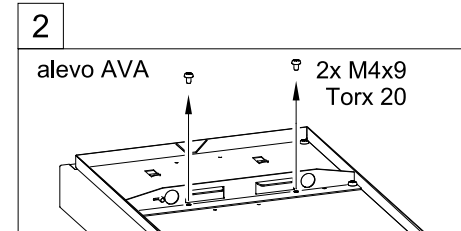
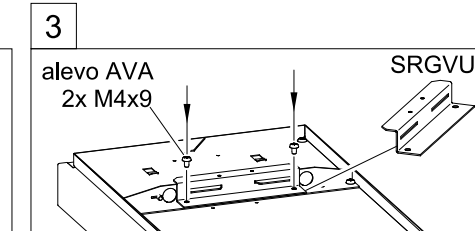
<p>1</p> <p>alevo AVA</p>  <p>2x M4x6 2x</p>	<p>2</p> <p>alevo AVA</p>  <p>2x M4x9 Torx 20</p>	<p>3</p> <p>alevo AVA</p>  <p>2x M4x9</p> <p>SRGVU</p>
--	--	--

4

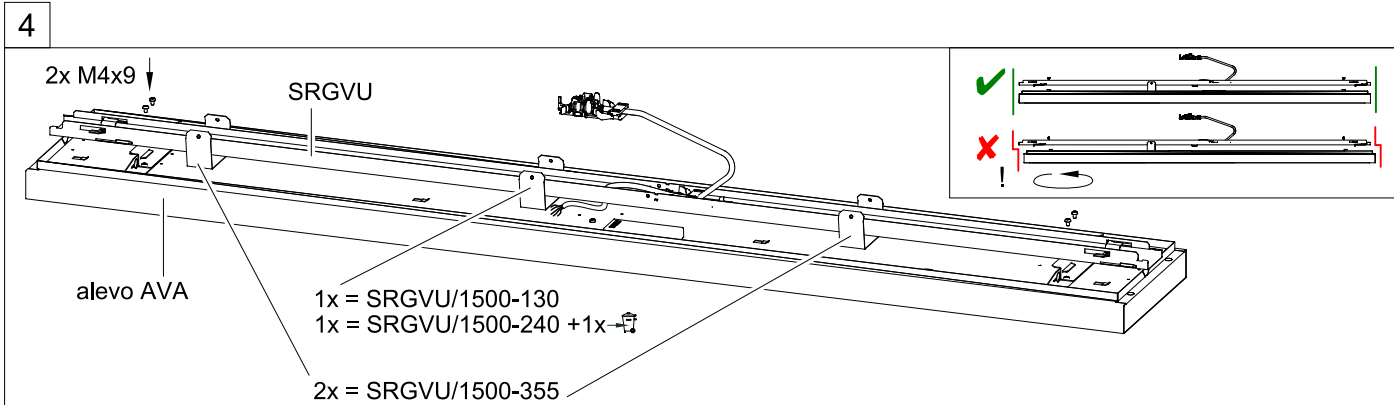

2x M4x9

SRGVU

alevo AVA

1x = SRGVU/1500-130
 1x = SRGVU/1500-240 + 1x →

2x = SRGVU/1500-355

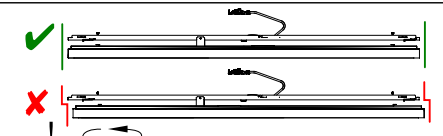

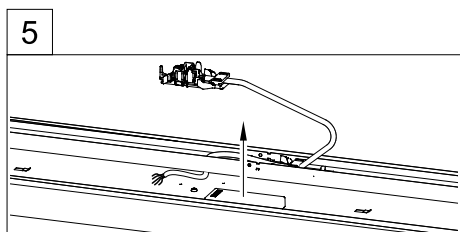
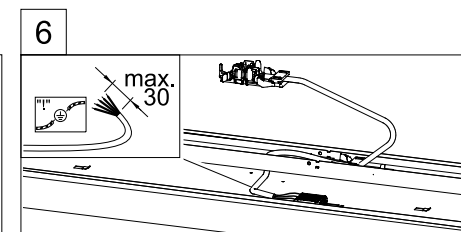
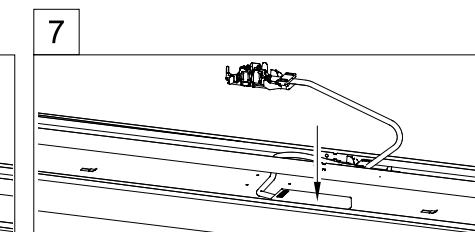
<p>5</p> 	<p>6</p>  <p>max. 30</p>	<p>7</p> 
---	---	---

