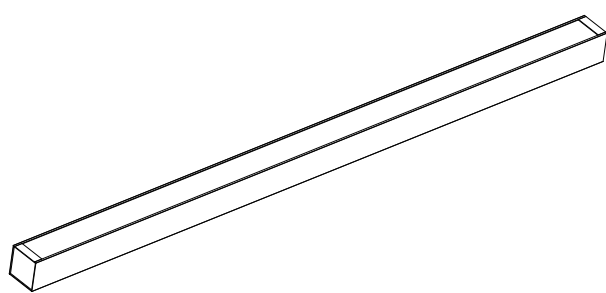
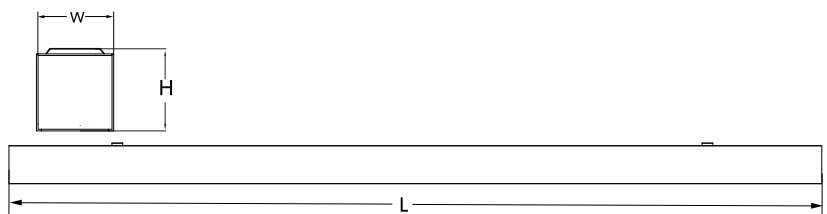

LEDLima BLE

Item Code	CCT	kg
542005004900	3000K	2.5 kg
542005004800	4000K	2.5 kg
542005004700	3000K	3.1 kg
542005004600	4000K	3.1 kg
542005004500	3000K	2.5 kg
542005004400	4000K	2.5 kg
542005004300	3000K	3.1 kg
542005004200	4000K	3.1 kg
599006009000*	/	0.09 kg

* Accessories should be purchased separately.

Model	L (mm)	W (mm)	H (mm)
LEDLima L12-15W-U19-BLE	1200	70	75
LEDLima L15-18W-U19-BLE	1500	70	75
LEDLima L12-30W-U22-BLE	1200	70	75
LEDLima L15-36W-U22-BLE	1500	70	75

Suspending

①  OFF
*Suspension Kit sold separately.

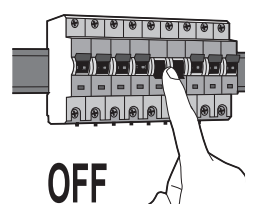
② 

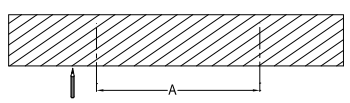
Model	A
LEDLima L12-15W-U19-BLE	800mm
LEDLima L15-18W-U19-BLE	800mm
LEDLima L12-30W-U22-BLE	1100mm
LEDLima L15-36W-U22-BLE	1100mm

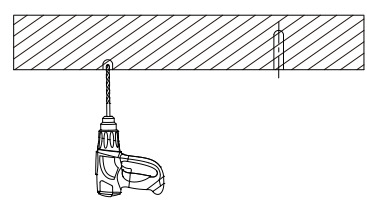
③ 

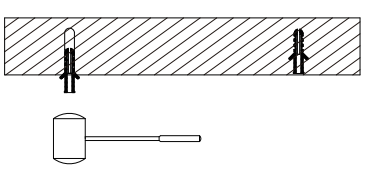
④ 

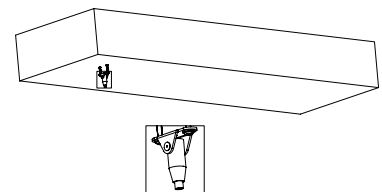
⑤ 

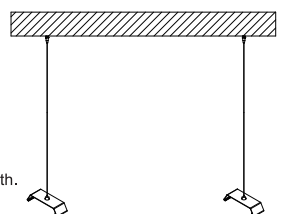
⑥  Press
Insert rope
Adjust length.

⑦  open

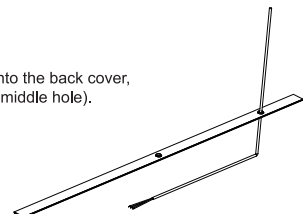
⑧  Insert 230V cable into the back cover, from side hole (not middle hole).

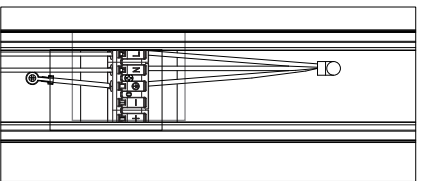
⑨ 

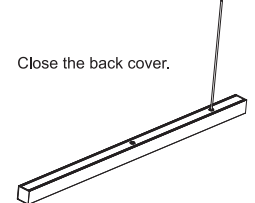
⑩  Close the back cover.

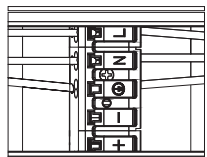
⑪  Line (Brown)
Neutral (Blue)
PE (Ground)

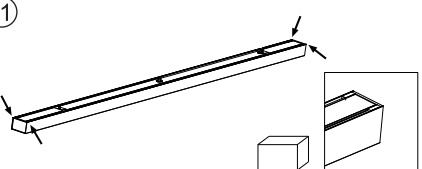
⑪  Push into the 4 sealing rubbers.

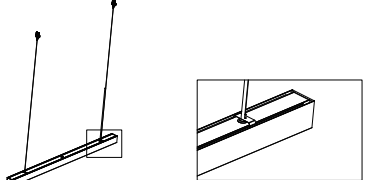
⑫  Mount the luminaire with bracket.

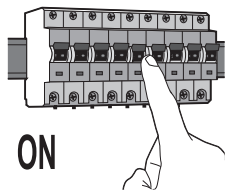
⑬  ON

Ceiling

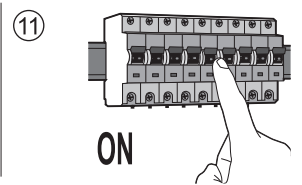
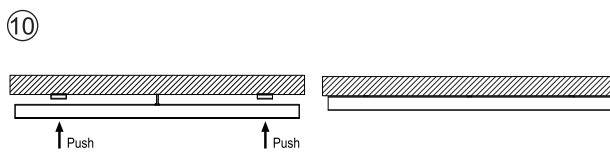
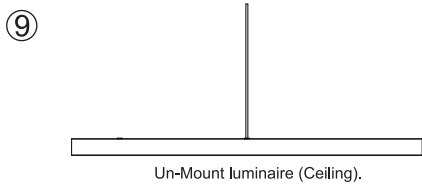
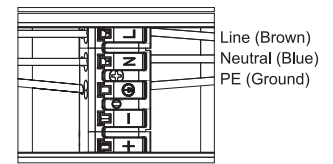
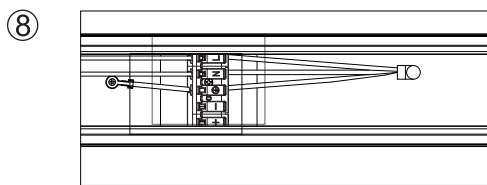
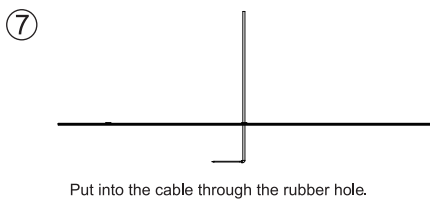
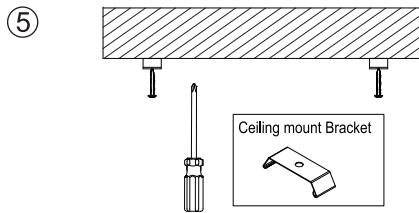
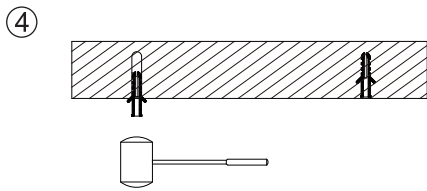
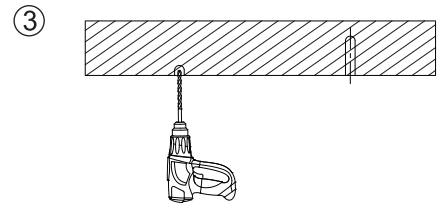
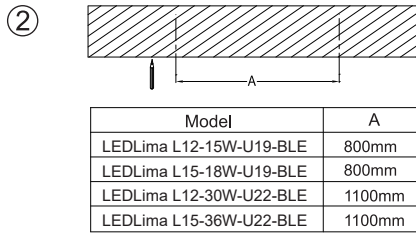
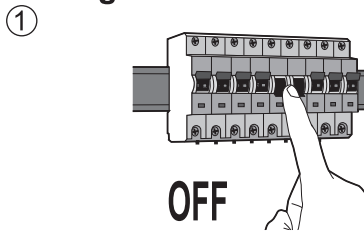

Unmount luminaire

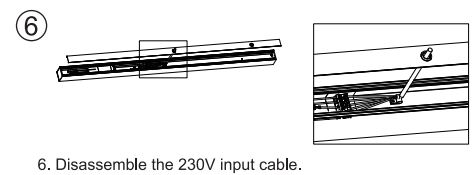
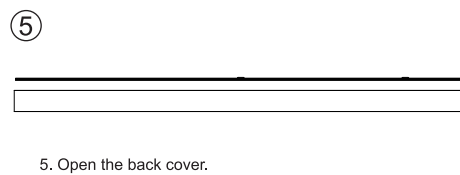
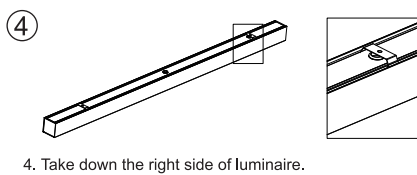
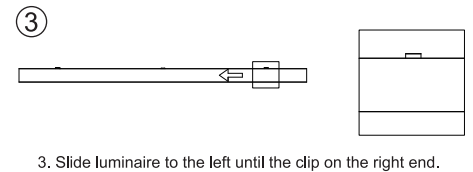
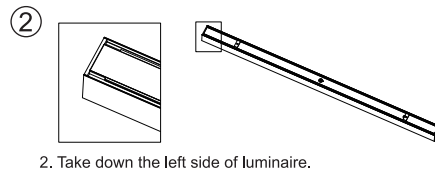
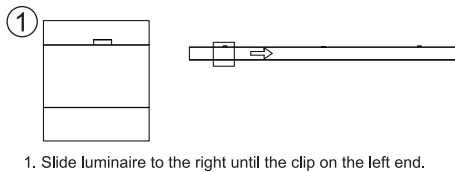

In case of damage to the wire, it has to be replaced only by the manufacturer, distributor or by an expert, to avoid risks.

Caution: Any operation on LED module is forbidden while power-on.

Zur Vermeidung von Risiken müssen defekte Leitungen ausschließlich vom Hersteller, Inverkehrbringer oder Fachmann ausgetauscht werden.

Achtung: In Betrieb ist keine Arbeit am LED-Modul erlaubt.

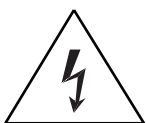

For non-user replaceable light sources.

The light source contained in this luminaire shall only be replaced by the manufacturer or his service agent or a similar qualified person.

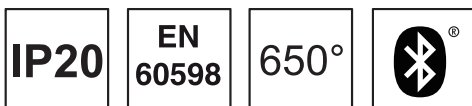

Bluetooth Operating Frequency: 2402-2480 MHz
Bluetooth Max Transmission Power: <20dBm

Suzhou Opple Lighting Co., Ltd.
215200
East Side, Fenyang Road,
Fenhu Economic Development Zone,
Wujiang City, Jiangsu Province,
P.R.China

OPPLE Lighting B.V.
Materiaalweg 6-6A
5681 RJ Best
The Netherlands
service@opple.com
www.opple.com