

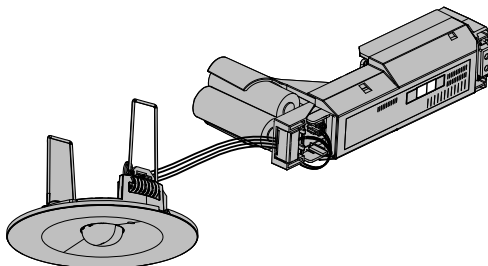

Voyager Star MR CR E3D

EMpowerLED PRO



EN Mounting instructions
Important notices. Please, read first! Keep the instructions safe! Specifications are subject to change without notice! If you have questions, please contact the manufacturer.

DE Montageanleitung
Wichtige Hinweise. Bitte zuerst lesen! Anleitung aufbewahren! Technische Änderungen vorbehalten! Bei Fragen wenden Sie sich an den Hersteller.

FR Notice de montage
Remarques importantes. À lire en premier lieu! Conservez cette notice! Modifications techniques sans préavis! Si vous avez des questions, veuillez contacter le fabricant.

IT Istruzioni di montaggio
Nota importanti. Si prega di leggere prima! Conservare le istruzioni! Modifiche tecniche senza preavviso! Per chiarimenti rivolgersi al produttore.

ES Instrucciones de montaje
Notas importantes. Por favor, lea primero! ¡Guarde las instrucciones! ¡Reservado el derecho de realizar modificaciones técnicas sin preaviso! Si tiene alguna pregunta, póngase en contacto con el fabricante.

NL Montagehandleiding
Belangrijke informatie. Gelieve eerst te lezen! Houd deze gebruiksaanwijzingen zorgvuldig bij! Technische wijzigingen blijven voorbehouden! Als u vragen hebt, kan u contact opnemen met de fabrikant.

SV Installationsanvisning
Viktigt information. Läs först! Spara anvisningen! Med reservation för tekniska ändringar! Om du har frågor ber vi dig ta kontakt med tillverkaren.

FI Asennusohje
Tärkeä huomautus. Lue ensin! Säilytä käyttöopas! Oikeudet teknisiin muutoksiin pidätetään! Lähetä mahdolliset kysymykset valmistajalle.

RU Инструкция по монтажу
Важная информация. Просьба ознакомиться перед началом работ! Сохраняйте инструкцию! Компания сохраняет за собой право на внесение технических изменений. При возникновении вопросов обращайтесь к производителю.

PL Instrukcja montażu
Ważne wskazówki/ uwagi. Proszę pierwsze przeczytać całość instrukcji. Proszę zachować instrukcję! Zastrzega się prawo do wprowadzania zmian technicznych. W razie pytań skontaktuj się z producentem.

ZH 安装说明
重要提示。请先阅读！保留本说明！
请勿执行技术变动！
如有问题，请咨询制造商。

AR تعليمات التركيب
ملاحظات هامة. يرجى القراءة أولاً!
إبقاء التعليمات!
تخضع المواصفات للتغيير دون تقديم إشعار!
إذا كان لديك أسئلة، الرجاء الاتصال بالشركة المصنعة.

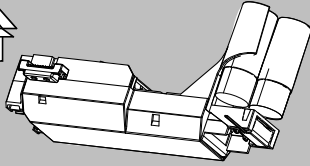

antipanic

spot

escape

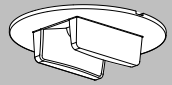

i **OPTION**
concrete casting surround:
22170982

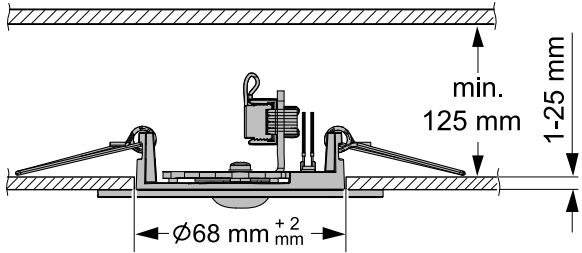
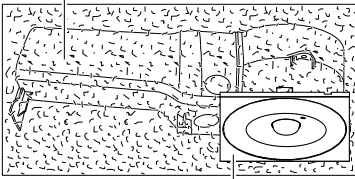

OPTION
quadratic cover:
22166854 (WH-white)
22166855 (SR-silver)

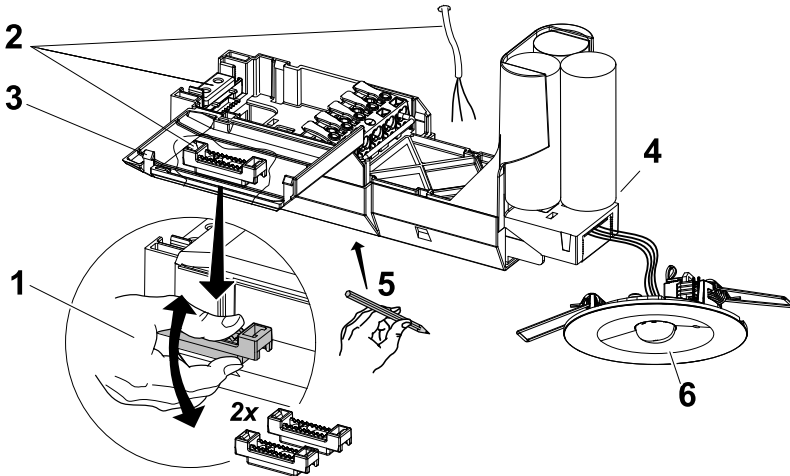

i **only spot version**

Die Leuchte sollte so positioniert sein, dass in einem Abstand näher als **0,71 m** vermieden wird, dauerhaft in die Leuchte zu starren.

The luminaire should be positioned so that prolonged staring into the luminaire at a distance closer than **0,71 m** is not expected.

Le luminaire doit être positionné de façon à ce que personne ne puisse le fixer du regard de manière prolongée à une distance inférieure à **0,71 m**.

Posizionare l'apparechio di illuminazione in modo da evitare di guardarvi a lungo ad una distanza inferiore a **0,71 m**. De armatuur moet zo worden geplaatst dat langdurig staren in de armatuur op een afstand van minder dan **0,71 m** niet worth verwacht.



Chemische Beständigkeit beachten. Nur kunststoffverträgliche Reinigungsmittel verwenden.

Note: Due to problems with chemical resistance, choose cleaning materials which are suitable for plastic.

Respectez la résistance chimique du matériel: n'utilisez que des détergents compatibles avec les matières synthétiques.

Rispettare la resistenza chimica del materiale: utilizzare solo detersivi compatibili con materiali plastici.

Rekening houden met chemische weerstand. Gelieve enkel reinigingsmiddelen te gebruiken die Kunststoffvriendelijk zijn.



escape

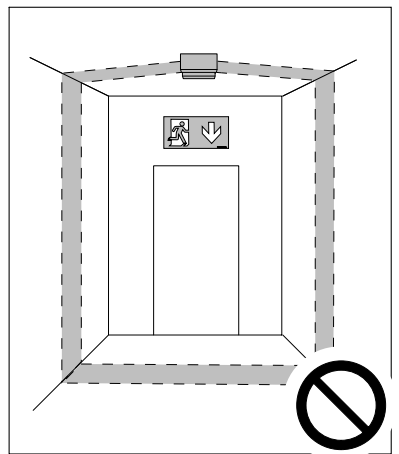
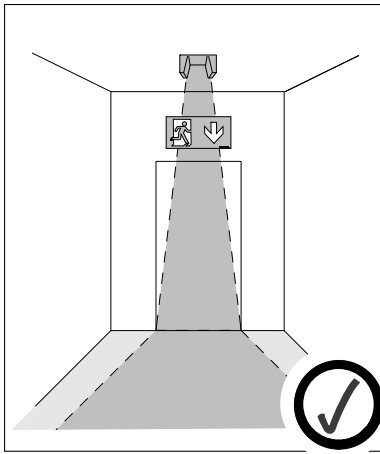
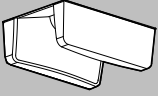

2

i (page 5)

max. (5x) 2,5 mm² (solid/stranded wire)
E30: max. (5x) 2,5 mm² (solid/stranded wire)

OPTION!



max. 2,5 mm²

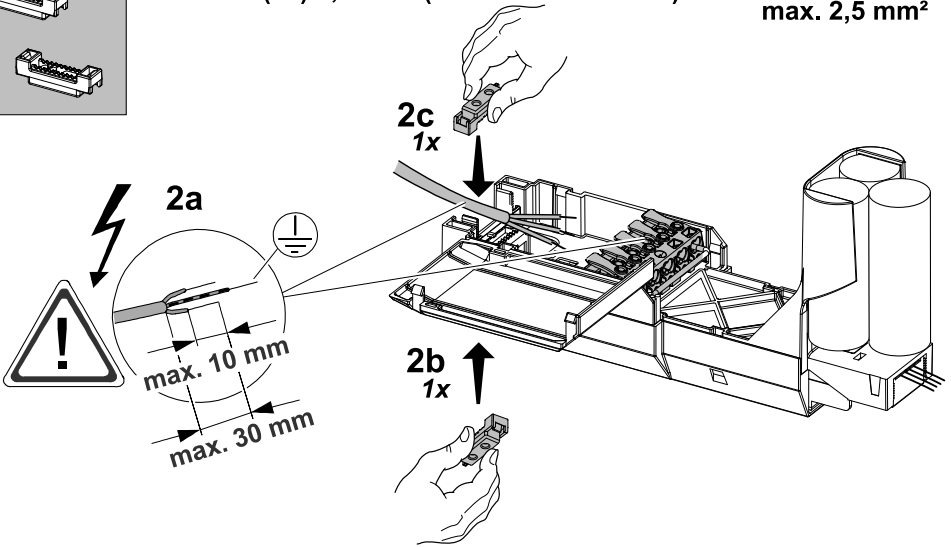
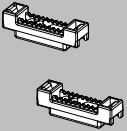

3

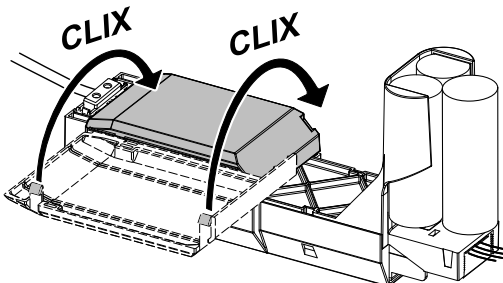

4

4a

Commissioned Date:
Inbetriebnahme:

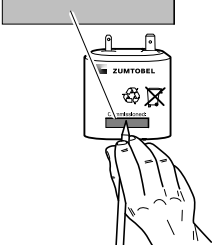

4b

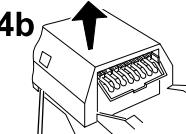

4d



4c

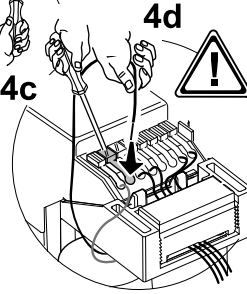

5

i

(page 5)

5a

(acc. IEC/EN 60598-2-22)
mode of operation: 0...6
facilities: A...F

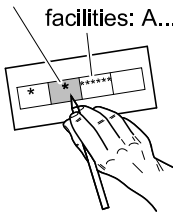

5b

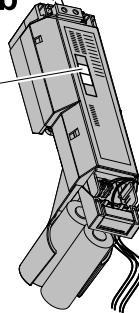

6

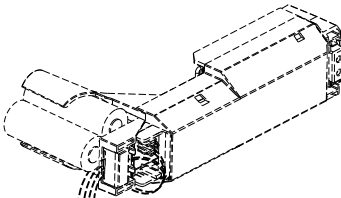

6b

6b

6a

6a

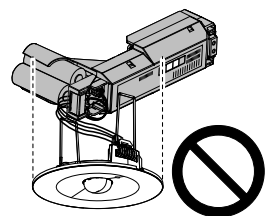
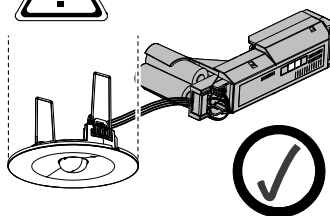
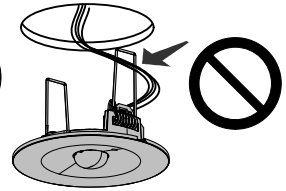
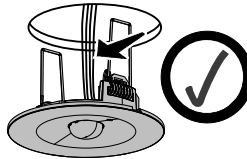
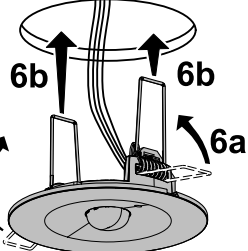

i E3D Status LED

| LED GREEN / GRÜN | Status |
|------------------|---|
| | Everything okay Alles o. k. |
| | Function test Funktionstest |
| | Service life test Betriebsdauerstest |
| | Disabled Blockiert |

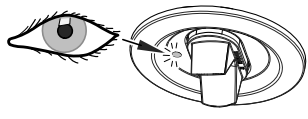

| LED RED / ROT | Status |
|---------------|-----------------------------------|
| | Lamp failure Lampenfehler |
| | Charging failure Ladefehler |
| | Battery failure Batteriefehler |

Change battery
Akku wechseln

i Luminaire marking (acc. IEC/EN 60598-2-22)

Supply version
X: self-contained version
Z: central battery version

Mode of operation
0: non-maintained mode
1: maintained mode

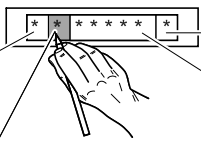

Facilities

- A:** including test device
- B:** including remote rest mode
- C:** including inhibiting mode
- D:** high risk task area luminaire
- E:** with non-replaceable lamp(s) and/or batteries
- F:** Control gear with automatic test facility according to IEC 61347-2-7, marked with EL-T
- G:** internally-lit safety sign

Autonomy time

- 60:** 1 hour
- 120:** 2 hours
- 180:** 3 hours
- 480:** 8 hours

! switching mode / DALI

Bereitschaftsschaltung;
Non-maintained mode;
Eclairage non permanent;
Circuito in emergenza;
Stand-byschakeling;
Encendido no permanente

Dauerschaltung;
maintained mode;
Mode permanent;
Circuito permanente;
Permanente schakeling;
Encendido permanente

Wire bridge

Geschaltetes Dauerlicht;
Switched maintained mode;
Ecl permanent active;
luce accesa permanente;
geschakelt permanent licht;
Luz constante encendida

Fuse

Wire bridge

i **Do not remove Jumper or change Jumper position. Jumper configures autonomy time. (manufacturer internal-only configuration)**

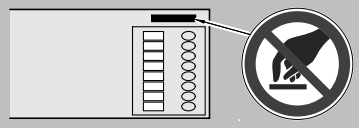

(DE) Hinweise für die Montage und den Betrieb!

Die Montage und Inbetriebnahme der Leuchte sowie jede Veränderung an der Leuchte darf nur von autorisierten Fachkräften (qualifizierter Elektriker) durchgeführt werden. Die nationalen Errichterbestimmungen sind zu beachten. Vor jeder Arbeit an der Leuchte ist diese vom Netz zu trennen. **Hot Plug-in ist nicht möglich und kann zu Schäden an der Leuchte führen!**



Der Hersteller haftet nicht für Schäden, die aus fehlerhafter Montage, unsachgemäßem Betrieb oder unautorisierten Veränderungen an der Leuchte resultieren.

Vorsicht, Gefahr eines elektrischen Schlags.

Technische Änderungen vorbehalten! Bei Fragen wenden Sie sich an den Hersteller.

(EN) Instructions for installation and operation!

The installation and commissioning of the luminaire as well as any modification to the luminaire may only be performed by authorized personnel (qualified electrician). National installation regulations must be observed. Before any work on the appliance is done, it must be disconnected from mains.

Hot plug-in is not an option and may cause damage to the lamp or luminaire!



The manufacturer is not liable for damages resulting from improper or faulty installation or operation or from unauthorized modifications to the luminaire.

Caution, risk of electric shock! Specifications are subject to change without notice!

If you have questions, please contact the manufacturer.

(FR) Instructions pour l'installation et l'utilisation!

L'installation et la mise en service du luminaire ainsi que toute modification au luminaire doivent être effectuées par un personnel autorisé (électricien qualifié). Les règles nationales d'installation doivent être respectées. Avant toute intervention sur l'appareil, il doit être débranché de son alimentation.

Le branchement à chaud est interdit, et peut endommager à la lampe ou le luminaire!



Le fabricant décline toute responsabilité pour les dommages résultant d'une mauvaise installation ou opération, ou d'une modification non autorisée du luminaire.

Avertissement, risque de choc électrique. Sous réserve de modifications des spécifications techniques! Pour toute question, contactez le fabricant.

(IT) Istruzioni per l'installazione e il funzionamento!

L'installazione e la messa in servizio degli apparecchi, nonché qualsiasi modifica dell'apparecchio può essere eseguita solo da personale autorizzato (elettricista qualificato). Le norme nazionali di installazione devono essere rispettate. Prima di qualsiasi intervento sull'apparecchio, questo deve essere scollegato dalla rete.

Non è possibile un Hot Plug In e può causare danni alla lampada o all'apparecchio!



Il produttore non si assume alcuna responsabilità per i danni derivanti da un'installazione impropria o difettosa, o per modifiche non autorizzate apportate all'apparecchio.

Attenzione, rischio di folgorazione! Modifiche tecniche sono soggette a cambiamenti senza preavviso! Se avete domande, si prega di contattare il produttore.

(NL) Aanwijzingen voor installatie en bediening!

De installatie en inbedrijfstelling van het armatuur, alsook elke wijziging in of aan het armatuur mogen alleen door bevoegd personeel (elektricien) worden uitgevoerd. De nationale installatie voorschriften moeten worden nageleefd. Voor alle werkzaamheden aan het apparaat, moet deze worden losgekoppeld van het net.

Hot plug-in is niet mogelijk en kan schade aan de lichtbron of het verlichtingstoestel veroorzaken!



De fabrikant is niet aansprakelijk voor schade als gevolg van onjuiste of foutieve installatie, bediening of schade welke het gevolg zijn van niet geautoriseerde wijzigingen aan het armatuur.

WAARSCHUWING: Gevaar voor elektrische schokken.

Technische wijzigingen voorbehouden! Als u vragen hebt, kunt u contact opnemen met de fabrikant.

i Info on (non-) replaceability:

