

[CZ] Montážní návod
 [DE] Montageanleitung
 [DK] Monteringsvejledning
 [EE] Paigaldusjuhend
 [FI] Asennusohje
 [FR] Notice de montage
 [HU] Szerelési útmutató
 [IT] Istruzioni di montaggio

[LT] Montavimo Instrukcijos
 [LV] Instalācijas instrukcija
 [NO] Monteringsanvisning
 [PL] Instrukcja montażu
 [RU] Инструкция по монтажу
 [SE] Installationsanvisning
 [UK] Installation Instructions

THORN



Main Office

Thorn Lighting
 Durhamgate
 Spennymoor
 County Durham
 DL16 6HL
 United Kingdom
 T +44 0 191 365 2222
 info.uk@zumtobelgroup.com

Punch 3 LV

Surface / Suspended
 Continuous row

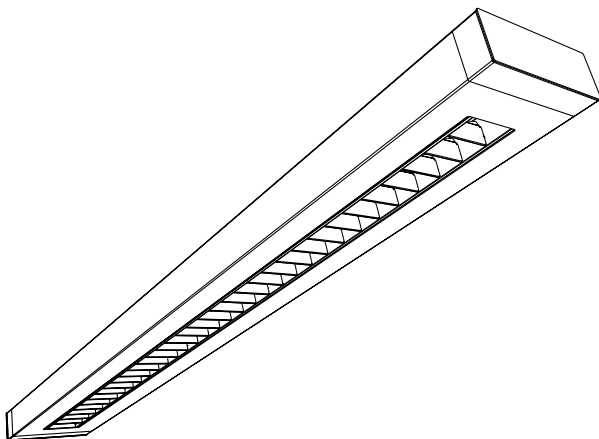

A Surface-mounted

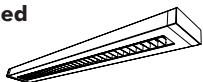

B Suspended

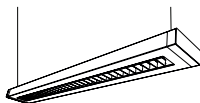

C Suspended continuous row

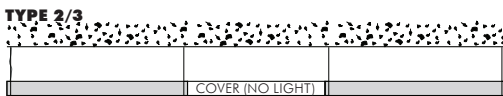
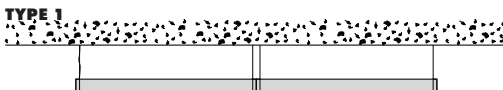
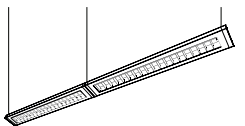

GET IN TOUCH
<http://www.thornlighting.com/PNC3>

THORN

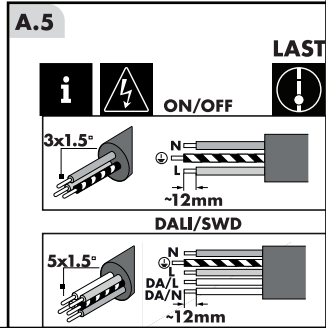
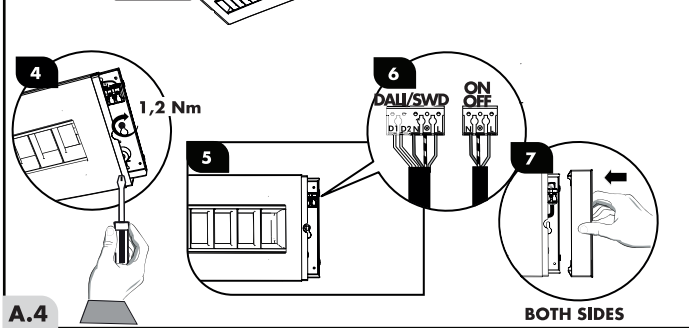
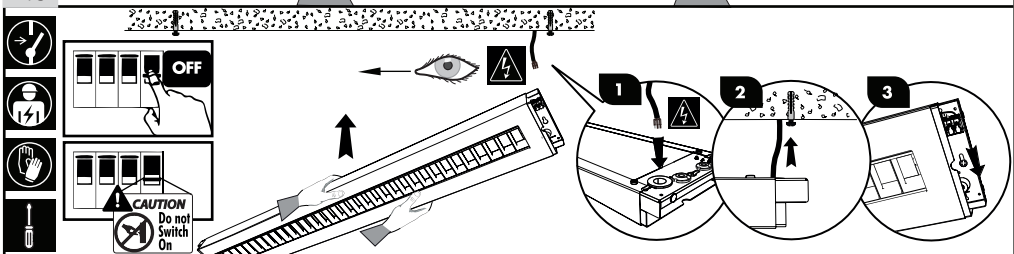
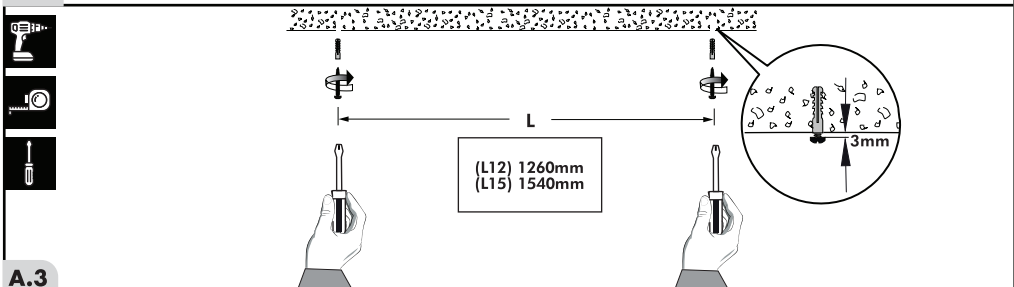
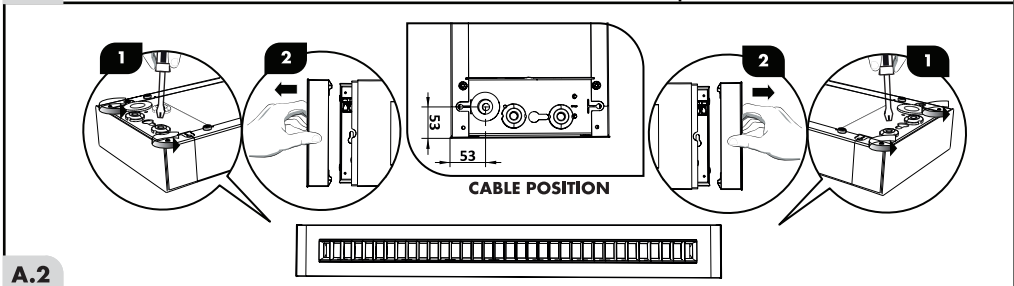
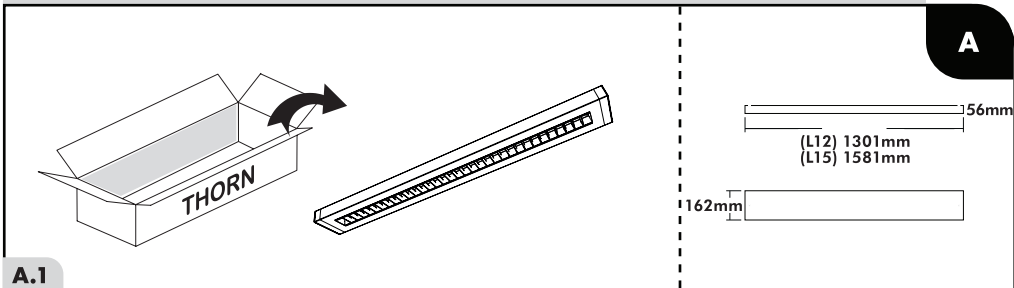

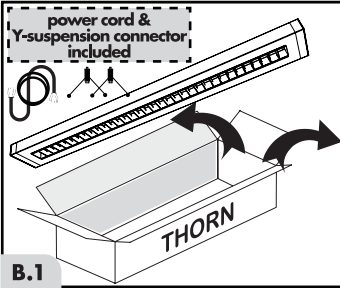

suspension kit

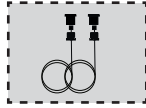

i ceiling rose & suspension cord must be ordered separately

art.code 96667068

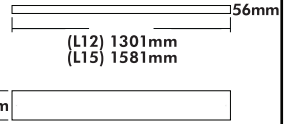

B.1

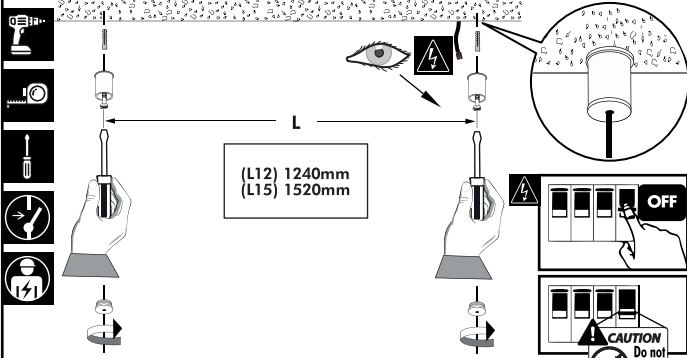

B.2

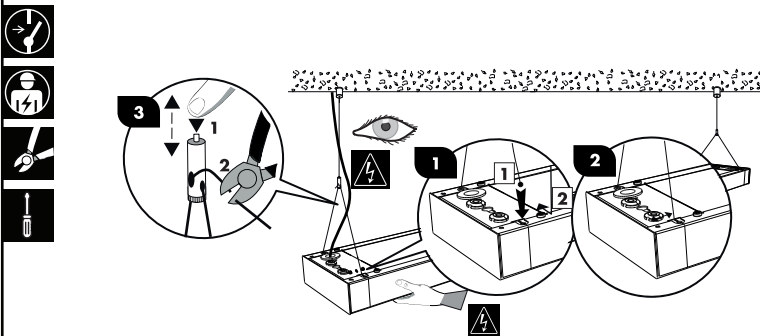

B.3

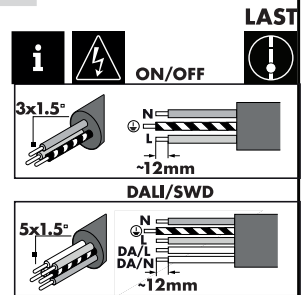

B.4

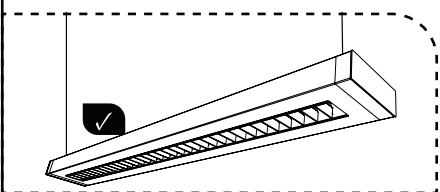

Punch 3 LV (MSP) "Suspended continuous row"

power cord & Y-suspension connector included

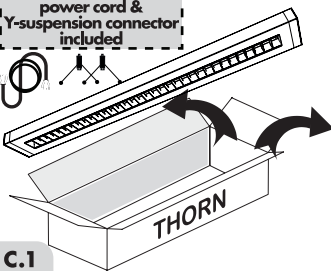

continuous row
Type 1
(1pcs)
L:54mm

continuous row
Type 2/3
(1pcs)
L:900mm
L:1500mm

suspension kit

through wiring
(1.8m)

ceiling rose & suspension cord must be ordered separately

56mm

(L12) 1301mm
(L15) 1581mm

162mm

C.1

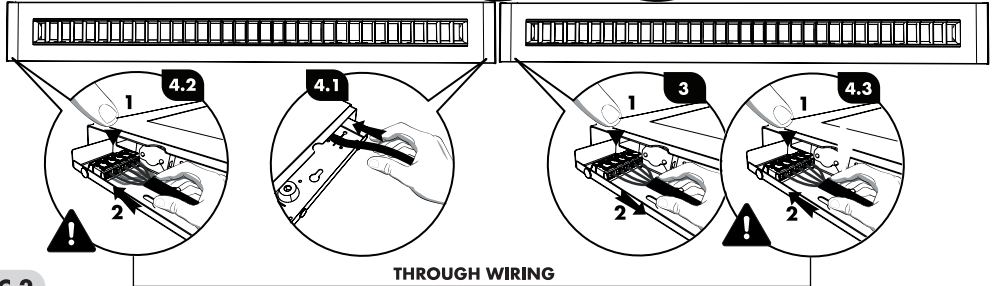
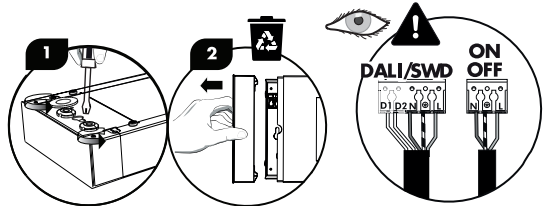
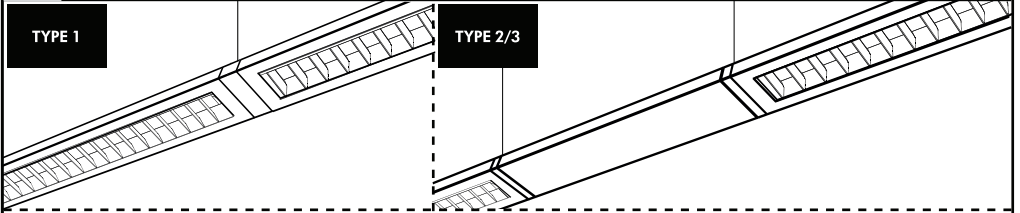

C.2

(L12) 1240mm
(L15) 1520mm

C.4

LAST

i **ON/OFF**

3x1.5° -12mm

DALI/SWD

5x1.5° -12mm

CAUTION
Do not Switch On

C.3

TYPE 1

TYPE 2/3

through wiring individual power supply

through wiring

individual power supply

C.4



After the installation steps and commissioning of the luminaire according your mounting type (MSC) or (MSP), the steps below are only for version with Emergency kit

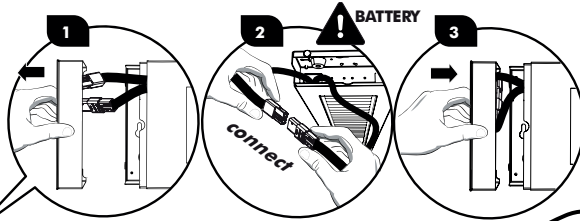

POWER CORD

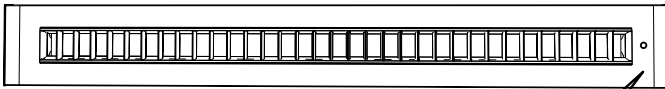
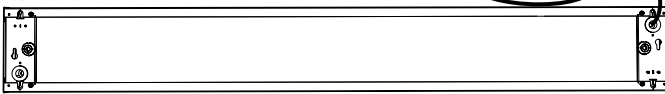

Status LED

- Intermittent green: battery regeneration after commissioning as well as after each battery replacement
- Permanent green: battery correctly connected, battery charged or self-test operation
- Flashing red: defective battery charge, battery not connected or battery capacity too low
- Flashing intermittent red: defective or unconnected LED luminaire unit
- Off: battery totally flat, defective emergency lighting unit or in emergency operation

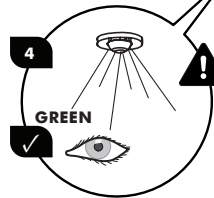

EMERGENCY LED STATUS

LAST

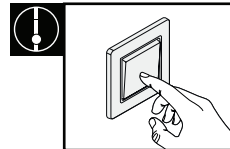

• Please indicate the Commissioned Date on the label

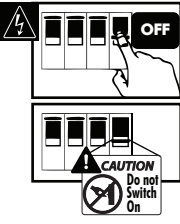

Replace the battery (order art. N 96636058)

This manual contains important information regarding the proper replacement of battery pack of this luminaire. Before installing and use of the luminaire, read and understand all instructions, cautions, notes and warnings, as well as all of the labels affixed to the luminaire.

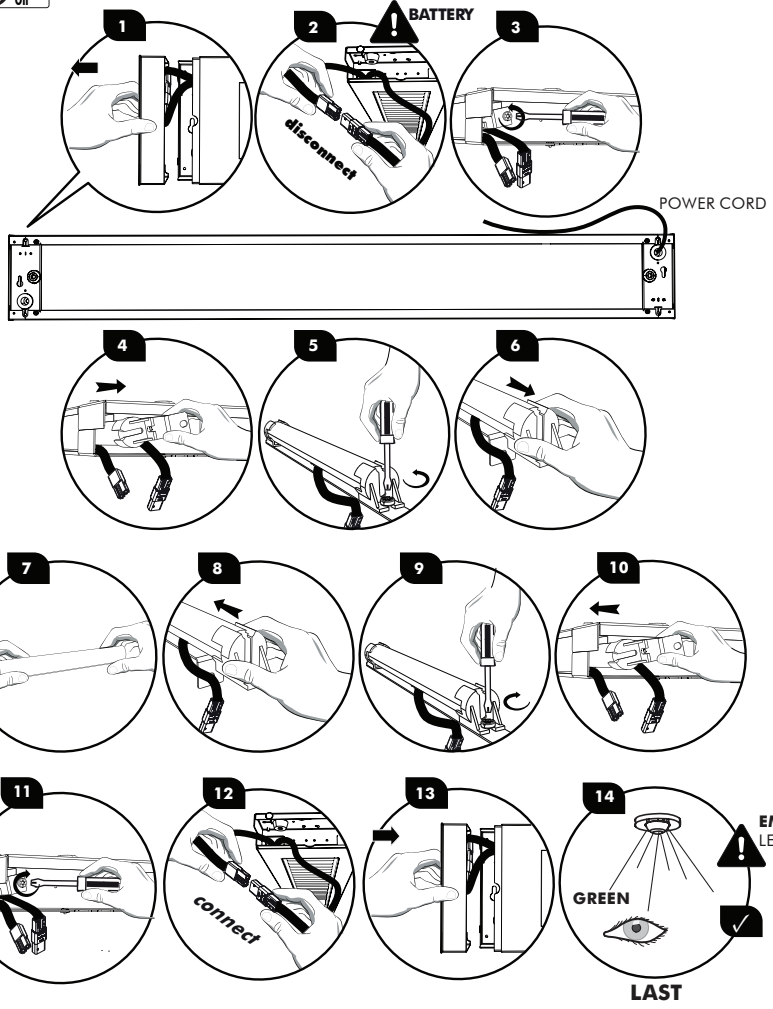

• Please indicate the Commissioned Date on the label

High Temp. LFP Battery
Installation date:

1	2	3	4	5	6	7	8	9	10	11	12
2021	2022	2023	2024	2025	2026	2027					



LiFePO4 3.2V - 4.5 Ah - 14.4Wh