

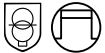

25W Multiple-Stage Constant Current Mode LED Driver

LCM-25DA series



AC Input: 200-240Vac
(for DA2-Type only)

IS 15885(Part 2/Sec13)
R-41027766
(except for DA2-Type)(except for DA2-Type)

Features

- Constant Current mode output with multiple levels selectable by dip switch
- Emergency lighting application is available according to IEC61347-2-13
- Built-in active PFC function and class II design
- Standby power consumption <0.5W
- Functions: DALI interface(logarithm or linear dimming curve selectable), push dimming synchronization up to 10units
- 3 years warranty

Applications

- LED indoor lighting
- LED office lighting
- LED commercial lighting
- LED panel lighting
- Industrial lighting

GTIN CODE

MW Search: <https://www.meanwell.com/serviceGTIN.aspx>

Description

LCM-25DA series is a 25W AC/DC constant current mode output LED driver featuring the multiple levels selectable by dip switch and the DALI interface with the compliance to IEC62386. LCM-25DA operates from 180~277VAC and offers different current levels ranging between 350mA and 1050mA. Thanks to the efficiency up to 86%, with the fanless design, the entire series is able to operate for -30°C~+85°C case temperature under free air convection. In addition, LCM-25DA is equipped with push dimming and synchronization functions, so as to provide the optimal design flexibility for LED lighting system.

Model Encoding

LCM - 25DA

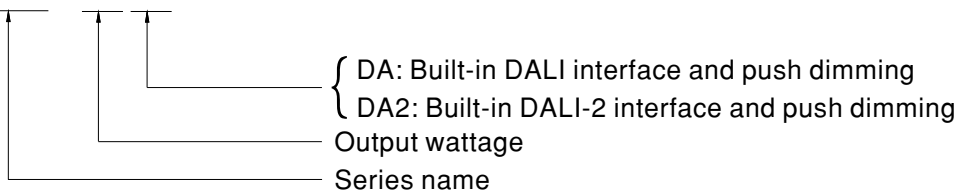



SPECIFICATION

MODEL		LCM-25□					
OUTPUT	CURRENT LEVEL	Current level selectable via DIP switch, please refer to "DIP SWITCH TABLE" section					
		350mA	500mA	600mA	700mA(default)	900mA	1050mA
	RATED POWER	18.9W	25.2W				
	DC VOLTAGE RANGE	6 ~ 54V	6 ~ 50V	6 ~ 42V	6 ~ 36V	6 ~ 28V	6 ~ 24V
	OPEN CIRCUIT VOLTAGE (max.)	59V			41V		
	CURRENT RIPPLE	5.0% max. @rated current					
	CURRENT TOLERANCE	±5%					
	SETUP TIME	Note.3 Note.8	500ms / 230VAC				
INPUT	VOLTAGE RANGE	Note.2	180 ~ 277VAC 254 ~ 380VDC(254~375VDC for DA2-Type)				(Please refer to "STATIC CHARACTERISTIC" section)
	FREQUENCY RANGE	47 ~ 63Hz					
	POWER FACTOR (Typ.)	PF ≥ 0.94/230VAC, PF ≥ 0.91/277VAC@full load (Please refer to "POWER FACTOR (PF) CHARACTERISTIC" section)					
	TOTAL HARMONIC DISTORTION	THD < 20% (@load ≥ 50%/230VAC; @load ≥ 75%/277VAC) (Please refer to "TOTAL HARMONIC DISTORTION(THD)" section)					
	EFFICIENCY (Typ.)	Note.4	86%				
	AC CURRENT (Typ.)	0.17A/230VAC 0.15A/277VAC					
	INRUSH CURRENT (Typ.)	COLD START 20A(twidth=260µs measured at 50% Ipeak) at 230VAC; Per NEMA 410					
	MAX. No. of PSUs on 16A CIRCUIT BREAKER	26 units (circuit breaker of type B) / 44 units (circuit breaker of type C) at 230VAC					
	LEAKAGE CURRENT	<0.5mA / 240VAC					
STANDBY POWER CONSUMPTION	Note.5	<0.5W					
PROTECTION	SHORT CIRCUIT	Constant current limiting, recovers automatically after fault condition is removed					
	OVER TEMPERATURE	Shut down o/p voltage, recovers automatically after temperature goes down					
FUNCTION	DIMMING	Please refer to "DIMMING OPERATION" section					
	SYNCHRONIZATION	Please refer to "SYNCHRONIZATION OPERATION" section					
ENVIRONMENT	WORKING TEMP.	Tcase=-30 ~ +85°C (Please refer to "OUTPUT LOAD vs TEMPERATURE" section)					
	MAX. CASE TEMP.	Tcase=+85°C					
	WORKING HUMIDITY	20 ~ 90% RH non-condensing					
	STORAGE TEMP., HUMIDITY	-40 ~ +80°C, 10 ~ 95% RH					
	TEMP. COEFFICIENT	±0.03%/°C (0 ~ 50°C)					
	VIBRATION	10 ~ 500Hz, 2G 10min./1cycle, period for 60min. each along X, Y, Z axes					
SAFETY & EMC	SAFETY STANDARDS	UL8750(except for DA2-Type), CSA C22.2 NO.250.0-08, ENEC BS EN/EN61347-1, BS EN/EN61347-2-13, BS EN/EN62384 independent, GB19510.14, GB19510.1, BIS IS15885(except for DA2-Type), EAC TP TC 004 approved; According to BS EN/EN61347-2-13 appendix J suitable for emergency installations(EL)(AC Input: 200-240Vac)(for DA2-Type only)					
	DALI STANDARDS	IEC62386-101, 102, 207,251					
	WITHSTAND VOLTAGE	I/P-O/P:3.75KVAC ; I/P-DA:1.5KVAC ; O/P-DA:1.5KVAC					
	ISOLATION RESISTANCE	I/P-O/P:>100M Ohms / 500VDC / 25°C / 70% RH					
	EMC EMISSION	Note.6	Compliance to BS EN/EN55015, BS EN/EN61000-3-2 Class C(@load ≥ 50%) ; BS EN/EN61000-3-3; GB17625.1, GB17743, EAC TP TC 020				
EMC IMMUNITY	Compliance to BS EN/EN61000-4-2,3,4,5,6,8,11, BS EN/EN61547, light industry level(surge immunity Line-Line 2KV), EAC TP TC 020						
OTHERS	MTBF	2661.8K hrs min. Telcordia SR-332 (Bellcore) ; 213.3K hrs min. MIL-HDBK-217F (25°C)					
	DIMENSION	105*68*23mm (L*W*H)					
	PACKING	0.17Kg ; 72pcs/13.2Kg/1.04CUFT					
NOTE	<ol style="list-style-type: none"> All parameters NOT specially mentioned are measured at 230VAC input, rated current and 25°C of ambient temperature. De-rating may be needed under low input voltages. Please refer to "STATIC CHARACTERISTIC" sections for details. Length of set up time is measured at first cold start. Turning ON/OFF the driver may lead to increase of the set up time. Efficiency is measured at 500mA/50V output set by DIP switch. Standby power consumption is measured at 230VAC. The driver is considered as a component that will be operated in combination with final equipment. Since EMC performance will be affected by the complete installation, the final equipment manufacturers must re-qualify EMC Directive on the complete installation again. The ambient temperature derating of 3.5°C/1000m with fanless models and of 5°C/1000m with fan models for operating altitude higher than 2000m(6500ft). Based on IEC 62386-101/102 DALI power on timing and interruption regulations, the set up time needs to test with a DALI controller which can support for DALI power on function, otherwise the set up time will be higher than 0.5 second for DA2-type. To fulfill requirements of the latest ErP regulation for lighting fixtures, this LED power supply can only be used behind a switch without permanently connected to the mains. <p>※ Product Liability Disclaimer : For detailed information, please refer to https://www.meanwell.com/serviceDisclaimer.aspx</p>						

■ BLOCK DIAGRAM

PFC fosc : 45KHz
PWM fosc : 70KHz

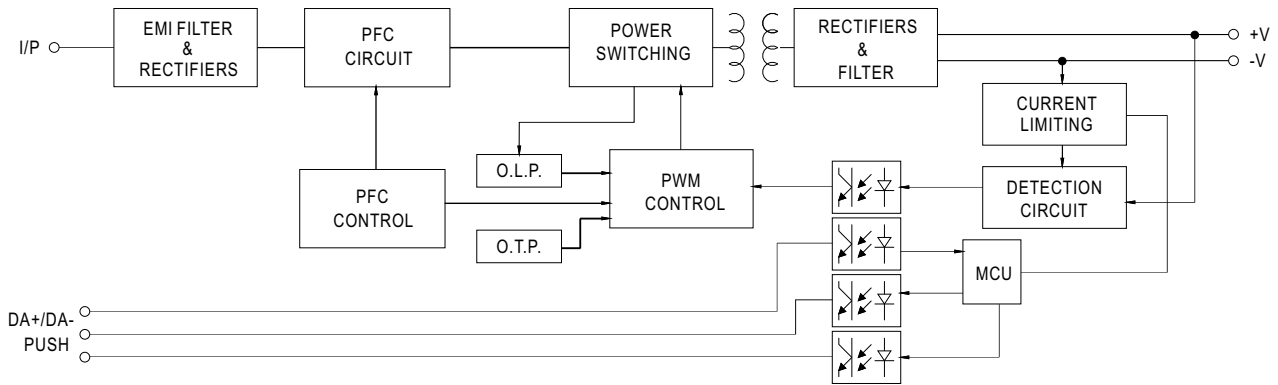

■ DIP SWITCH TABLE

LCM-25DA/DA2 is a multiple-stage constant current driver, selection of output current through DIP switch is exhibited below.

Io \ DIP S.W.	1	2	3	4	5	6
350mA	----	----	----	----	----	----
500mA	ON	----	----	----	----	----
600mA	ON	ON	----	----	----	----
700mA(factory default)	ON	ON	ON	----	----	ON
900mA	ON	ON	ON	ON	----	ON
1050mA	ON	ON	ON	ON	ON	ON

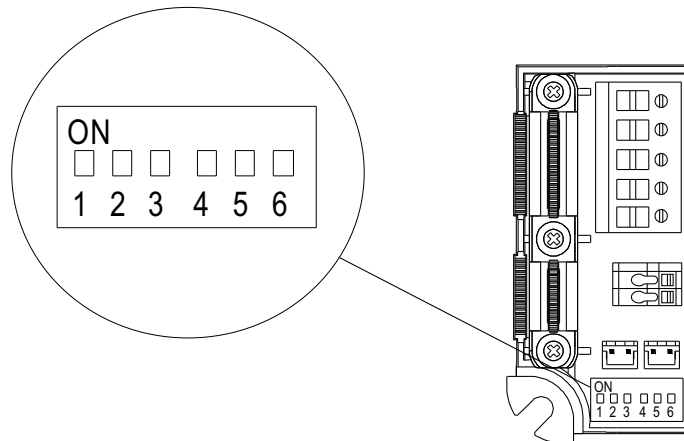

Note: For more current setting, please contact MW's sales.

■ DIMMING OPERATION

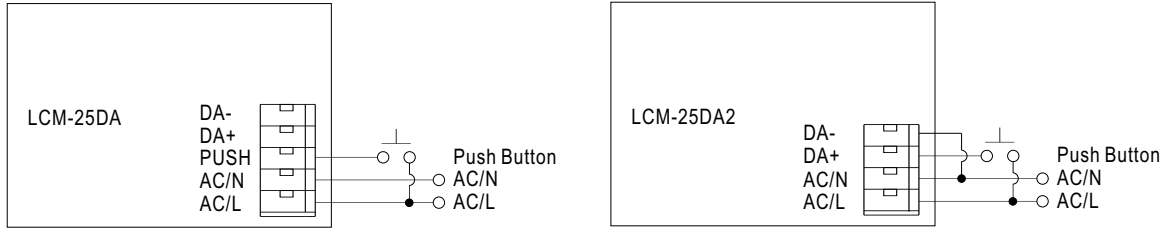

※**PUSH dimming(primary side)**

Action	Action duration	Function
Short push	0.1~1 sec.	Turn ON-OFF the driver
Long push	1.5~10 sec.	Every Long Push changes the dimming direction, dimming up or down
Reset	>11 sec.	Set up the dimming level to 100%

- The factory default dimming level is at 100%.
- If the push action lasts less than 0.05 sec., it will not lead to a change for the status of the driver.
- Up to 10 drivers can perform the PUSH dimming at the same time when utilizing one common push button.
- The maximum length of the cable from the push button to the last driver is 20 meters.
- The additive push button can be connected only between the PUSH terminal, as displayed in the diagram, and AC/L (in brown or black); it will lead to short circuit if it is connected to AC/N.

※**DALI interface(primary side; for DA/DA2-Type)**

- Apply DALI signal between DA+ and DA-
- DALI protocol comprises 16 groups and 64 addresses.
- First step is fixed at 6% of output.

■ **SYNCHRONIZATION OPERATION**

- Synchronization up to 10 drivers (1 master + 9 slaves)
- Dimming operating range : 10%~100%
- Sync cable length : < 5m
- Sync cable type : Flat cable
- Sync cable cross section area : 22 – 24 AWG (0.2~0.3mm²)

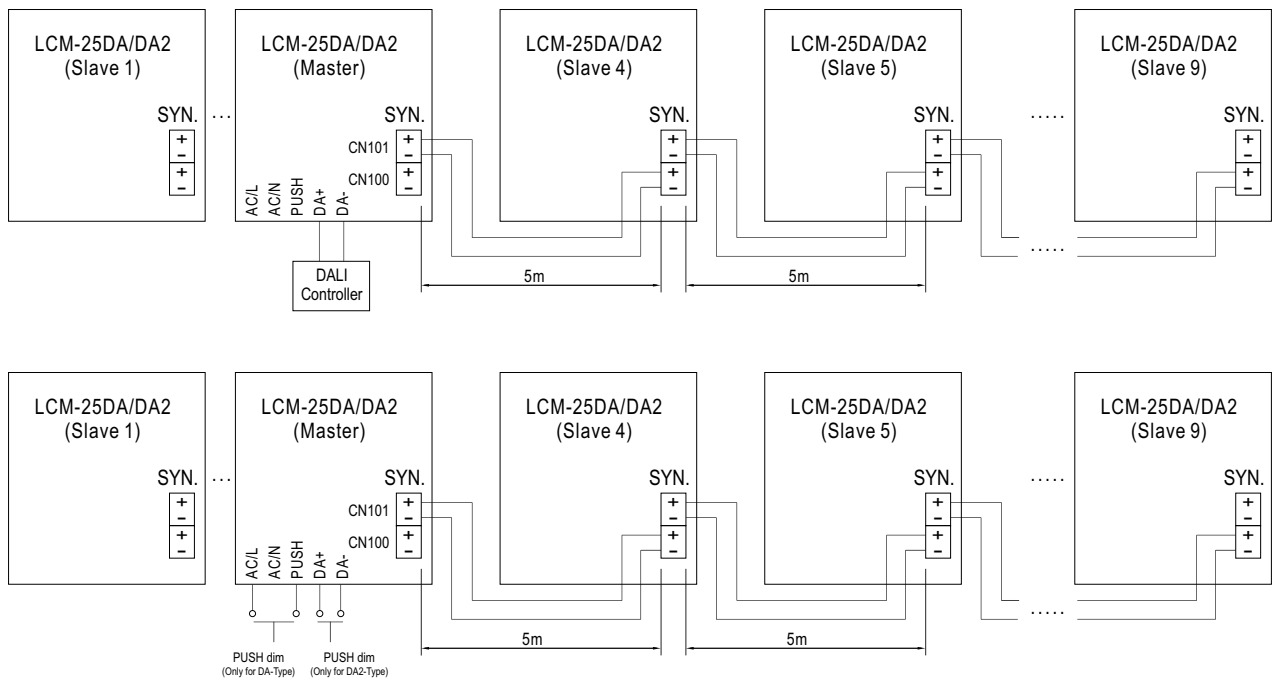

- CN100, CN101 : used to synchronously control the LCM units in parallel.

NOTE : 1. Please make sure all units are set to 100% dimming setting (factory default) before synchronizing.
 2. Min. Dimming operating range depends on dimmer setting.

■ **OUTPUT LOAD vs TEMPERATURE**

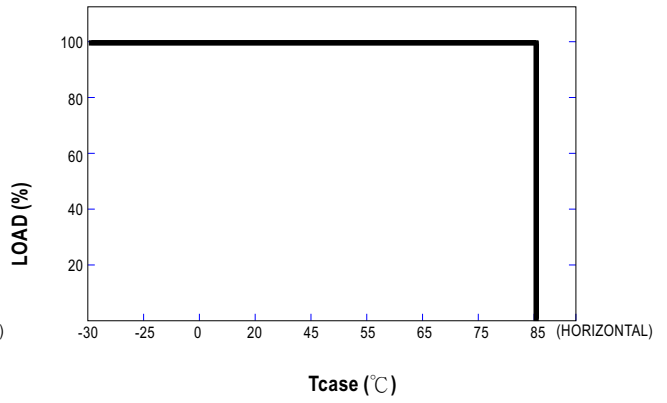
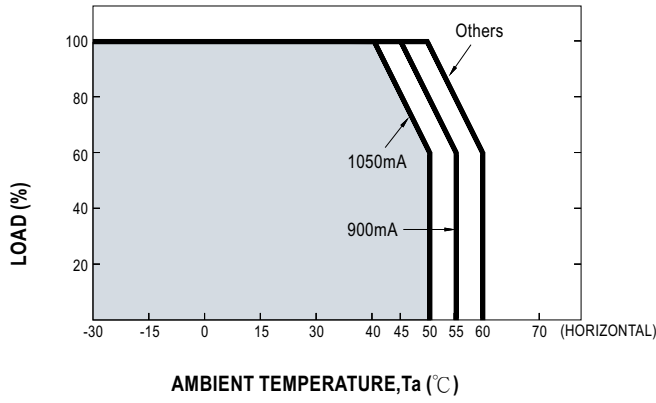

■ **STATIC CHARACTERISTIC**

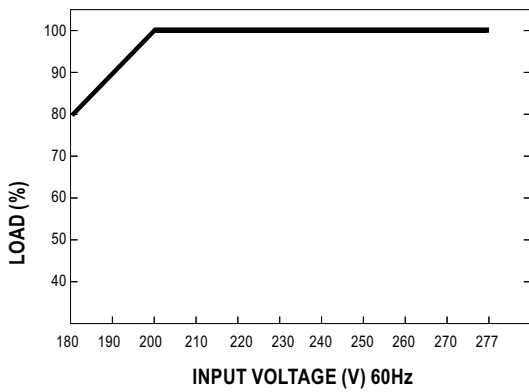

※ De-rating is needed under low input voltage.

TOTAL HARMONIC DISTORTION (THD)

※ Tcase at 75°C

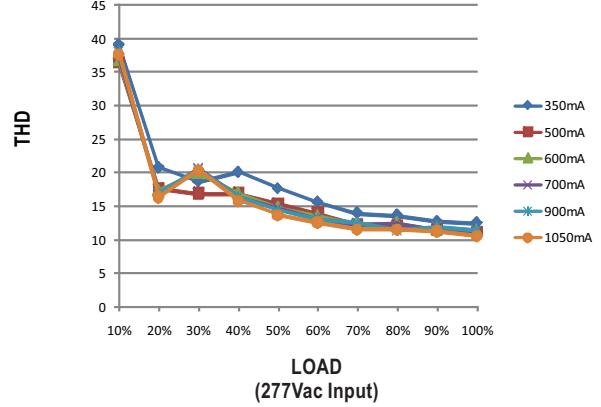
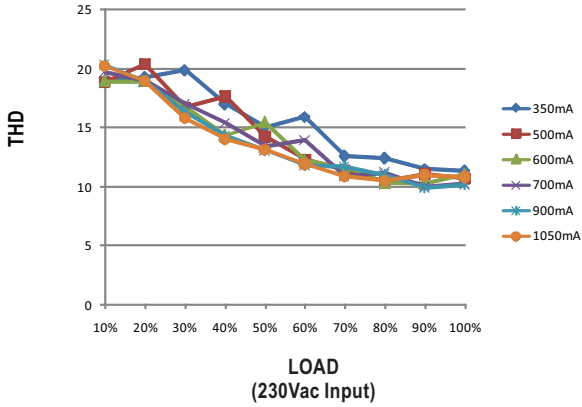

POWER FACTOR (PF) CHARACTERISTIC

※ Tcase at 75°C

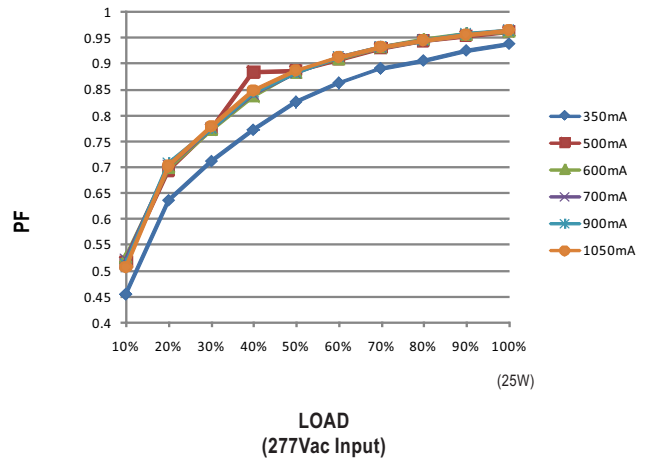
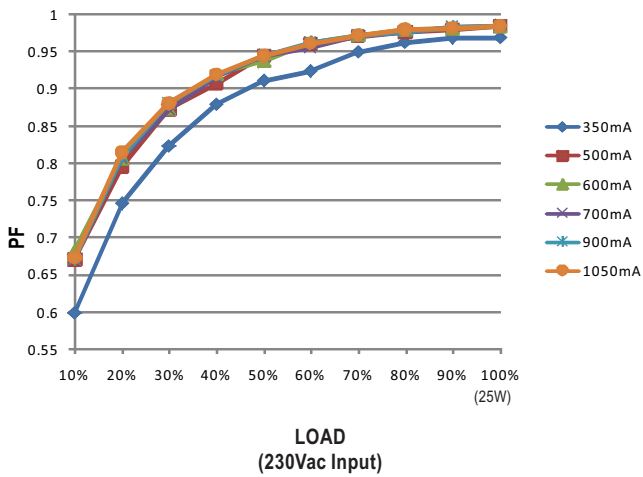

EFFICIENCY vs LOAD

LCM-25DA series possess superior working efficiency that up to 86% can be reached in field applications.

※ Tcase at 75°C

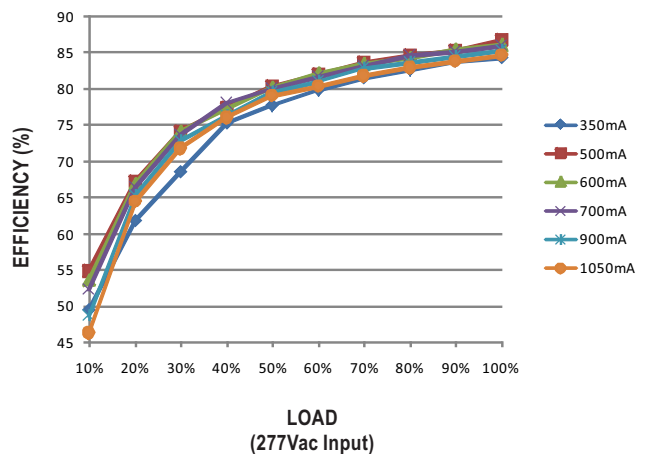
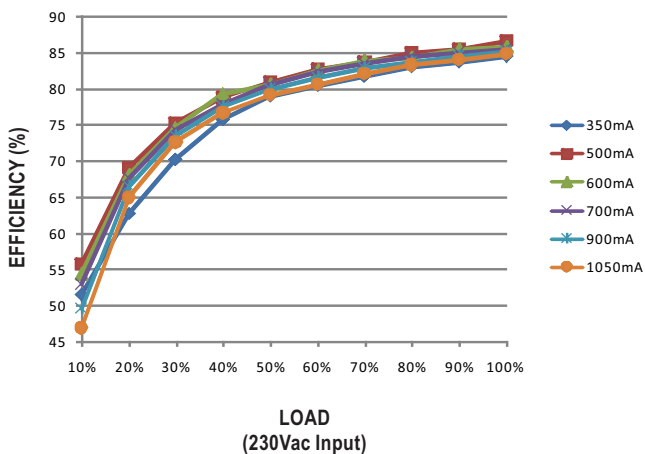

MECHANICAL SPECIFICATION

Case No.LCM-25 Unit:mm

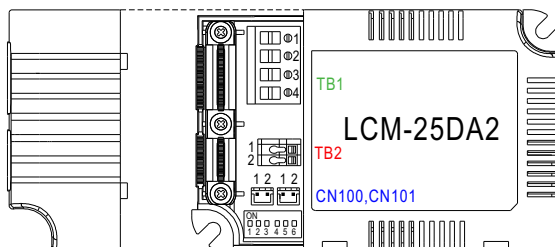
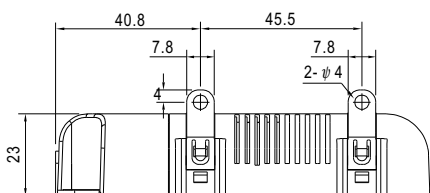
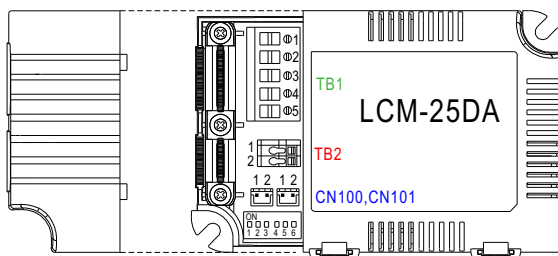
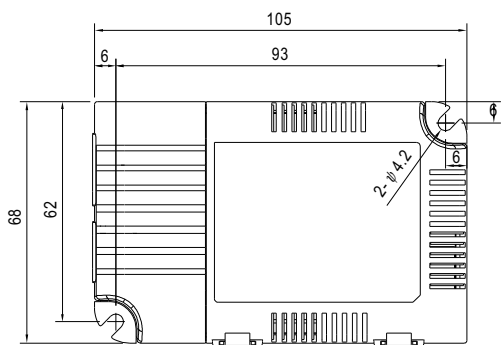

※ Terminal Pin No. Assignment(TB1)(LCM-25DA)

Pin No.	Assignment	Pin No.	Assignment
1	AC/L	4	DA+
2	AC/N	5	DA-
3	PUSH		

※ Terminal Pin No. Assignment(TB1)(LCM-25DA2)

Pin No.	Assignment	Pin No.	Assignment
1	AC/L	4	DA+
2	AC/N		
3	DA-		

※ Terminal Pin No. Assignment(TB2)

Pin No.	Assignment
1	+V
2	-V

※ SYN. Connector(CN100/CN101):JST B2B-PH-KL or equivalent

Pin No.	Assignment	Mating Housing	Terminal
1	-	JST PHR-2 or equivalent	JST SPH-002T-P0.5S or equivalent
2	+		

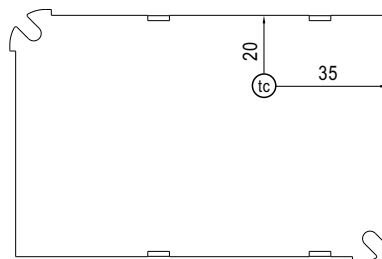

Bottom View

• (tc) : Max. Case Temperature

Note:Please use wires with a cross section of 0.5~2.5mm²(14~20AWG) for TB1 and wires with a cross section of 0.5~1.5 mm²(16~20AWG) for TB2. Please use wires with a cross section of 0.126~0.205mm²(24~26AWG) for CN100/CN101

INSTALLATION MANUAL

Please refer to : <http://www.meanwell.com/manual.html>